

Reflex SI / Reflex SI Linear

Flush-mounted switch range

Overview of colours Reflex SI und Reflex SI Linear



Reflex SI
alpinwhite (-214)
with cover frame
alpinwhite (-214)
Rocker similar to
RAL 9010



Reflex SI Linear
alpinwhite (-214)
with cover frame
alpinwhite (-214)
Rocker similar to
RAL 9010

Product features

- ROHS compliant
- Flangingradius ≥ 2 mm
- Cover: Thermoplast (PC)
 - Shock-proof and fracture proof
 - UV-resistant
 - Free of PVC and halogen
- Suitable for channel installation

Technical data

Dimensions	
Rocker cover	54 mm x 54 mm
Cover frame 1gang	81 mm x 81 mm
Installation depth for Flush-mounted inserts	For flush-mounted boxes according to DIN 49073-1
Mounting height for switches	18 mm
For socket outlet	14 mm
Protection	IP 20
Operating temperature	-25 °C ... 40 °C
Storage temperature	-25 °C ... 40 °C

Design



Switch/push-button
Colour: alpinwhite



Serienschalter/Doppeltaster
Colour: alpinwhite



Busch-Memory-2gang-
dimmer®
Colour: alpinwhite



Busch-Comfortswitch



SCHUKO® socket outlet



Service socket outlet
With eject mechanism

Dimensional drawings of selected articles (Reflex SI)

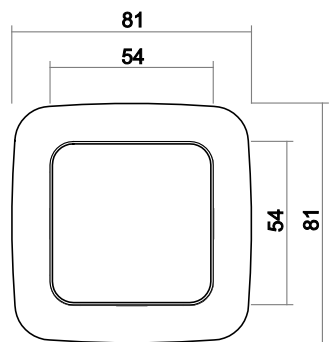

Switch

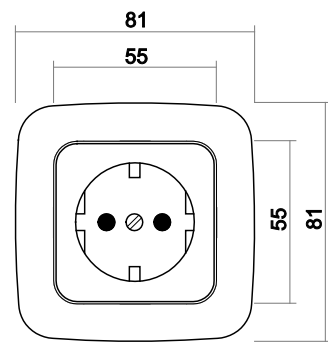
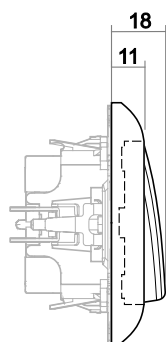

Socket outlet

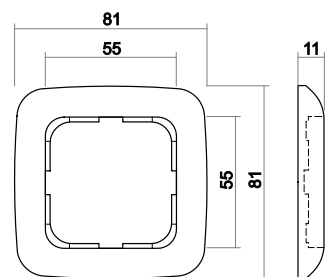
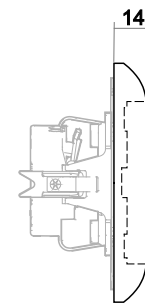

Cover frame 1gang

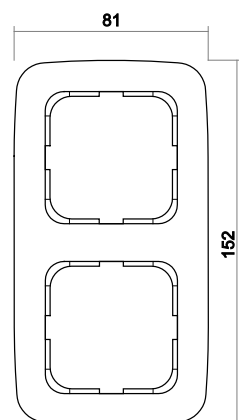

Cover frame 2gang

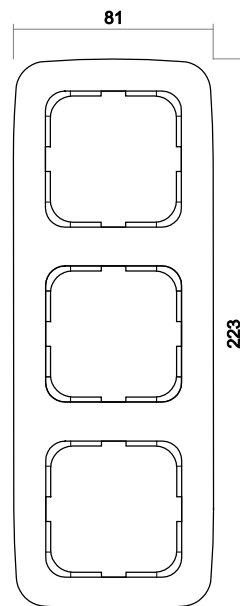

Cover frame 3gang

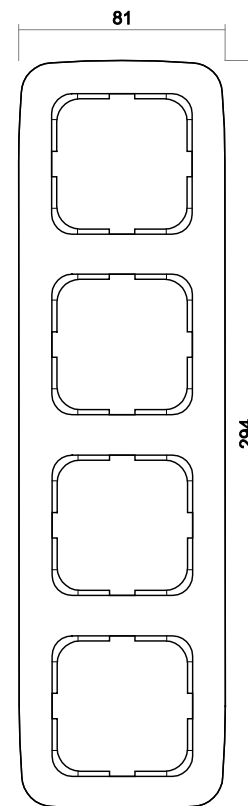

Cover frame 4gang

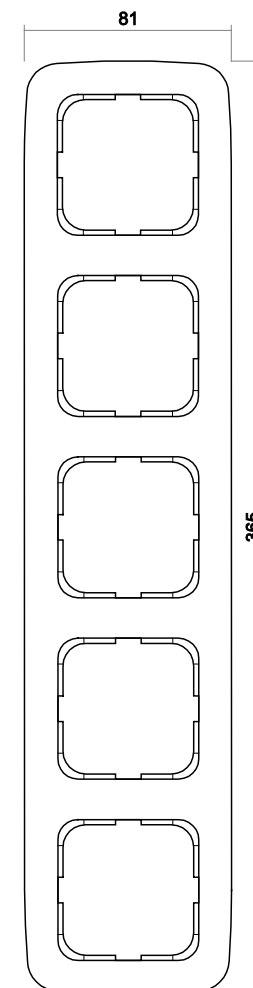

Cover frame 5gang

Dimensional drawings of selected articles (Reflex SI Linear)

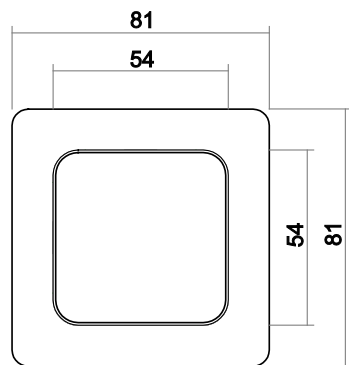

Switch

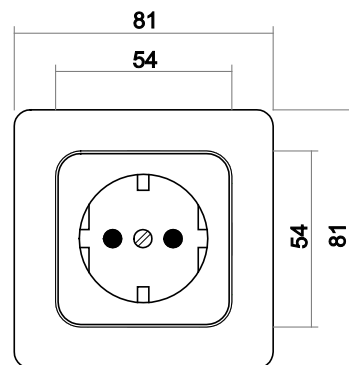
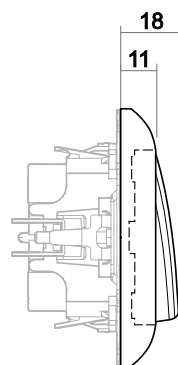

Socket outlet

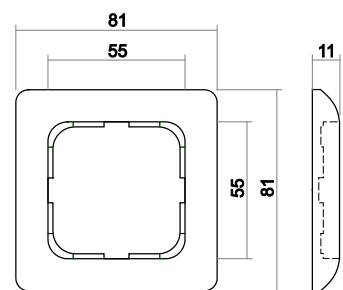
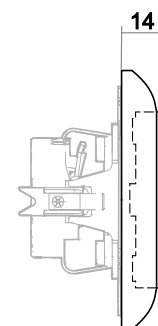

Cover frame 1gang

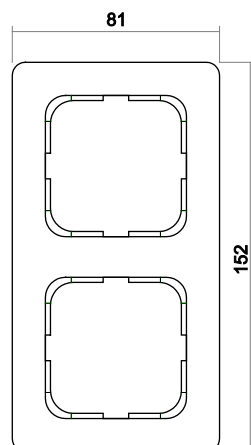

Cover frame 2gang

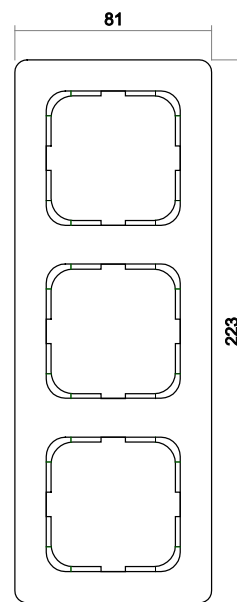

Cover frame 3gang

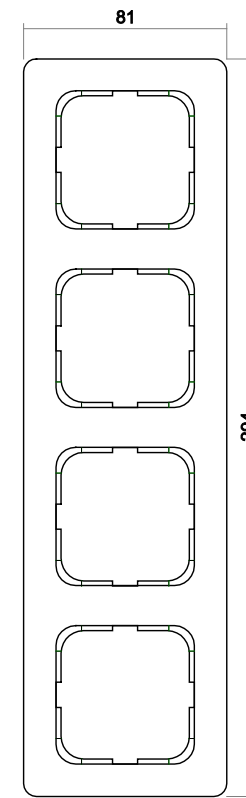

Cover frame 4gang

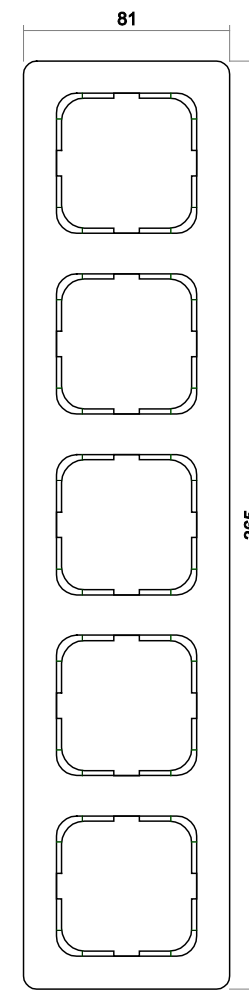

Cover frame 5gang

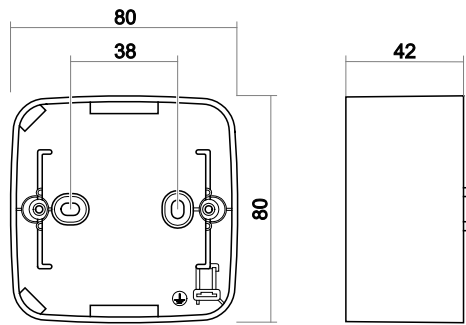

Surface mounted box 1gang

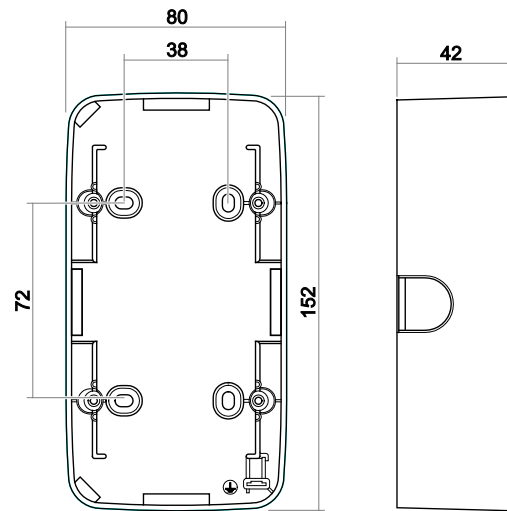

Surface mounted box 2gang

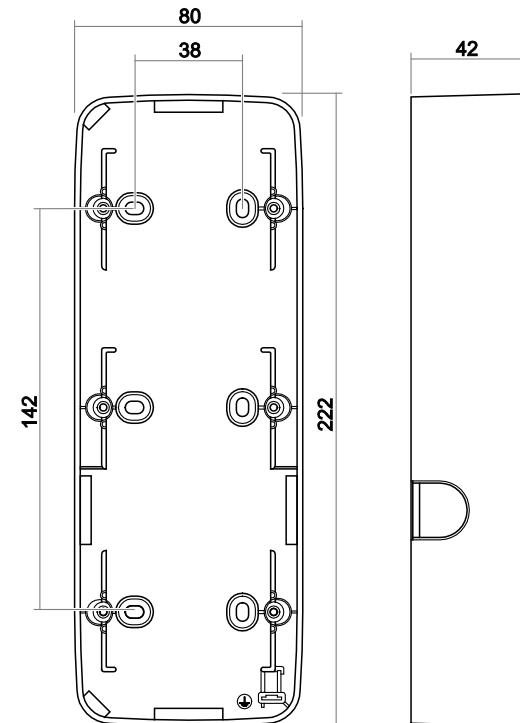

Surface mounted box 3gang

Experiencing the design of the Busch-Jaeger switch ranges with the light switch app. Free download for iOS and Android



Busch-Jaeger Elektro GmbH
 A member of the ABB group
 Freisenbergstraße 2
 58513 Lüdenscheid
 Zentraler Vertriebservice:
 02351-956-1600
www.busch-jaeger.de

Busch-Jaeger bei Facebook

Busch-Jaeger bei YouTube