

Busch-balance® SI

Unterputz Schalterprogramm

Farbübersicht



alpinweiß (-914)
ähnl. RAL 9010



rot (-917)
ähnl. RAL 9010

Produkteigenschaften

- ROHS konform
- Abdeckung: Thermoplast
 - schlag- und bruchfest
 - UV-beständig
 - PVC- und halogenfrei
- Für Kanalinstallation geeignet

Technische Daten

Maße

Wippe Abdeckung	55 mm x 55 mm
Abdeckrahmen 1fach	81 mm x 81 mm
Einbautiefe UP-Einsätze	Für UP-Dosen nach DIN 49073-1 (wenn nicht gesondert angegeben)

Aufbauhöhe Schalter	18 mm
Aufbauhöhe Steckdose	12 mm

Schutzart

IP 20

Betriebstemperatur

-5 °C ... 40 °C

Lagertemperatur

-25 °C ... 40 °C

Design

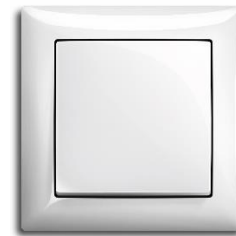

Taster Farbe: alpinweiß

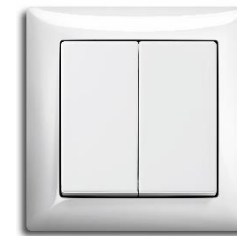

Serienwippe
Farbe: alpinweiß



Busch-Jalousiecontrol
Serienwippe
Farbe: alpinweiß



Busch-Komfortschalter®
Farbe: alpinweiß



SCHUKO® Steckdose
Farbe: alpinweiß

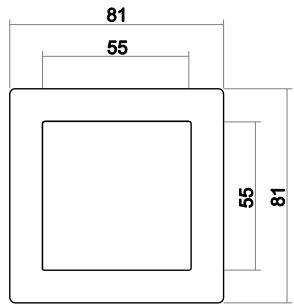

SCHUKO® USB-Steckdose mit
erh. Berührungsschutz
Farbe: alpinweiß

Maßzeichnungen ausgewählter Artikel

Schalter 1-fach

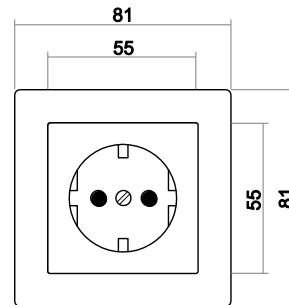
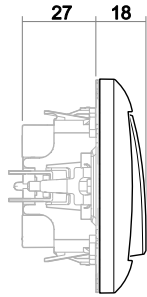

Steckdose 1-fach

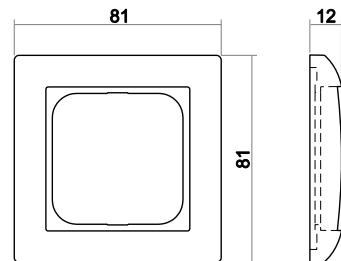
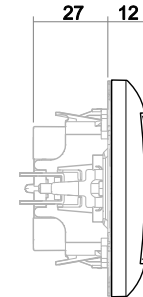

Abdeckrahmen 1-fach

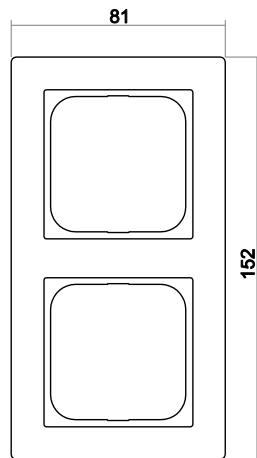

Abdeckrahmen 2-fach

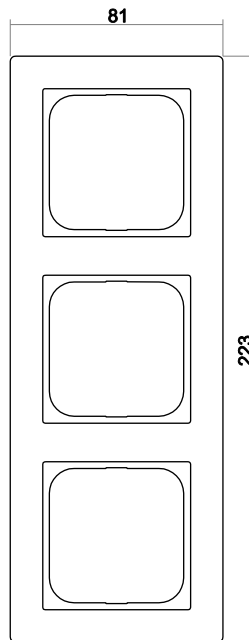

Abdeckrahmen 3-fach

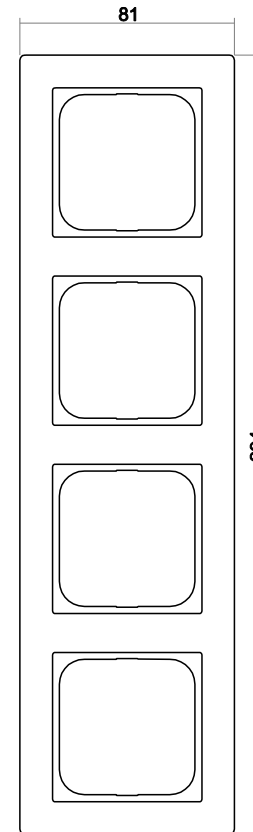

Abdeckrahmen 4-fach

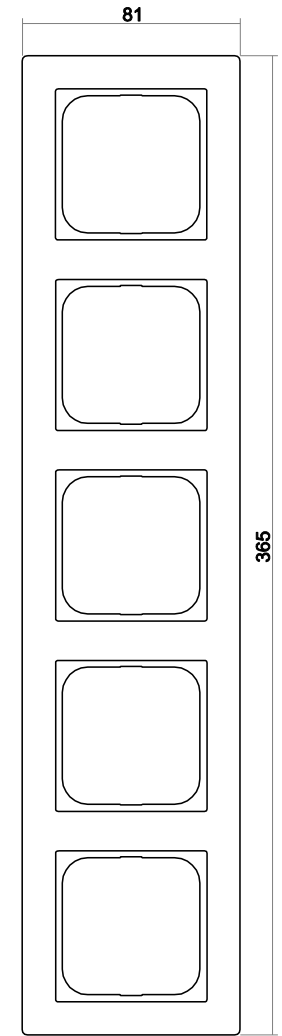

Abdeckrahmen 5-fach

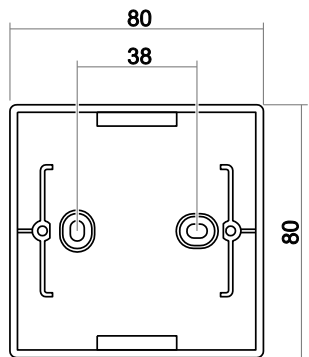

AP-Gehäuse 1-fach

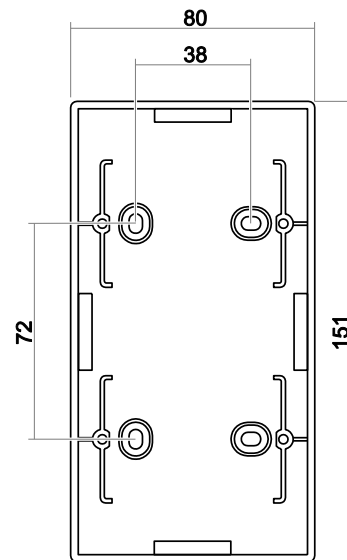

AP-Gehäuse 2-fach

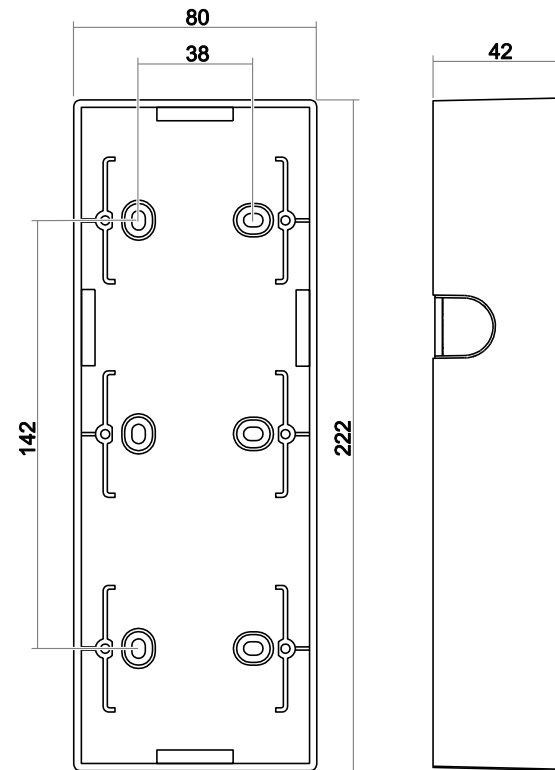

AP-Gehäuse 3-fach

Design der Busch-Jaeger
Schalterprogramme mit der
Lichtschalter-App erleben.
Kostenloser Download für
iOS und Android



Busch-Jaeger Elektro GmbH
Freisenbergstraße 2
58513 Lüdenscheid
Zentraler Vertriebsservice:
02351-956-1600
www.busch-jaeger.de

 [Busch-Jaeger bei Facebook](#)

 [Busch-Jaeger bei YouTube](#)