

KNX LED dimmer Constant
voltage 4gang

6155/30-500

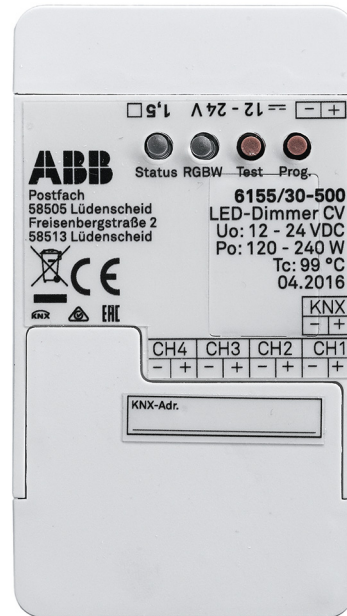

1	Notes on the instruction manual	5
2	Safety	6
2.1	Information and symbols used.....	6
2.2	Intended use.....	7
2.3	Improper use	7
2.4	Target group / Qualifications of personnel.....	8
2.5	Safety instructions	8
3	Information on protection of the environment	9
4	Setup and function	10
4.1	Features of function and equipment.....	10
4.2	Device overview	11
5	Technical data.....	12
5.1	Technical data	12
5.2	Dimensional drawings	13
6	Connection and mounting	14
6.1	Installation site.....	14
6.2	Electrical connection.....	14
7	Commissioning	15
7.1	Software	15
7.1.1	Preparation	15
7.1.2	Assigning a physical address.....	15
7.1.3	Assigning the group address(es)	15
7.1.4	Selecting the application program	15
7.1.5	Differentiating the application program.....	15
8	Operation	16
8.1	Control elements	16
8.2	Operating statuses	17
9	Maintenance	18
9.1	Cleaning	18
9.2	Maintenance-free device	18
10	Description of application and parameters.....	19
10.1	Application program.....	19
10.2	Overview of functions	19
10.3	Application "Global parameters".....	23
10.3.1	KNX LED dimmer to be programmed.....	23
10.3.2	Number of channels.....	23
10.3.3	Minimum value (MIN).....	23
10.3.4	Maximum value (MAX).....	23
10.3.5	Dimming procedure.....	24
10.4	Application "Status parameters".....	24
10.4.1	Message of the switching state.....	24
10.4.2	Message of the brightness value	25
10.4.3	Minimum change of the brightness value before it is sent.....	25
10.4.4	Activate error feedback signal.....	25
10.4.5	Saving the current status after 5 min.	25

10.5	Application "Switching parameters"	26
10.5.1	Activation with	26
10.5.2	Brightness value after the ON command	26
10.5.3	Delay before leaving OFF	27
10.5.4	Delay before the onset of OFF	28
10.5.5	Activation	29
10.5.6	Activation - Dimming speed at ON command	29
10.5.7	Activation - Dimming speed at OFF command	31
10.5.8	Activation with delay and dimming	33
10.5.9	Switch-off with delay and dimming	34
10.6	Application "Dimming parameters"	34
10.6.1	Dimming mode selection for absolute value	34
10.6.2	Dimming mode selection for absolute value — Absolute dimming speed by	35
10.6.3	Dimming mode selection for absolute value — Absolute dimming speed	35
10.6.4	Relative dimming speed by	36
10.6.5	Relative dimming speed	36
10.6.6	Permit relative OFF	36
10.7	Application "Bus voltage failure/return parameters"	36
10.7.1	Bus voltage return Message delay	36
10.7.2	Selection of bus voltage return value	37
10.7.3	Selection of bus voltage return value — Bus voltage return value of all channels"	37
10.7.4	Selection of bus voltage return value — Bus voltage return value channel 1 - 4	37
10.7.5	Selection of bus voltage failure value	38
10.7.6	Selection of bus voltage failure value - Bus voltage failure value all channels	38
10.7.7	Selection of bus voltage failure value - Bus voltage failure value channel 1 - 4	38
10.8	Application "Special functions"	39
10.8.1	Activate scenes	39
10.8.2	Activate scenes - Activate scene control	39
10.8.3	Activate colour cycle	39
10.8.4	Activate sequences	39
10.8.5	Activate flashing control	39
10.9	Application "Scene control"	40
10.9.1	Scene for parameter adjustment	41
10.9.2	Activate channel 1 - 4	41
10.9.3	Activate channel 1 - 4 — Channel 1 - 4 for activated scene	41
10.9.4	Scene control of all parameters	41
10.10	Application "Colour cycle control"	42
10.10.1	Colour cycle dimming speed via	42
10.10.2	Function of the RGBW colour cycle	43
10.10.3	Length of the colour cycle (RGB)	43
10.10.4	Length of the colour cycle (RGBW and RGB+W)	43
10.10.5	Length of the colour cycle WE (White Emotion)	43
10.10.6	Colour cycle description of functions	43
10.10.7	Setting after colour cycle stop	44
10.10.8	Setting after colour cycle stop — Brightness value of all channels	44
10.10.9	Setting after colour cycle stop — Brightness value of channel 1 - 4	44
10.11	Application "Sequence parameters"	45
10.11.1	Passage of time for a sequence	45
10.11.2	Activate sequence 1 - 5	46
10.11.3	Sequence 1 - 5 — Number of scenes in sequence 1 - 5	46

10.11.4	Sequence 1 - 5 — Activate channel 1 - 4	46
10.11.5	Sequence 1 - 5 — Setting after stop of the sequence.....	46
10.11.6	Sequence 1 - 5 — Setting after sequence stop — Brightness value of all channels	47
10.11.7	Sequence 1 - 5 — Setting after sequence stop — Brightness value of channel 1 - 4.....	47
10.11.8	Sequence 1 - 5 — Scene 0 - 15 — Channel 1 - 4	48
10.11.9	Sequence 1 - 5 — Scene 0 - 15 — Time in the scene	49
10.11.10	Sequence 1 - 5 — Scene 0 - 15 — Time for dimming to the next scene	49
10.12	Application "Flashing control parameter".....	50
10.12.1	Number of flashes.....	50
10.12.2	Flashing ON-time (1st colour).....	50
10.12.3	Flashing OFF-time (2nd colour).....	50
10.12.4	1st colour channel 1 - 4.....	50
10.12.5	2nd colour with.....	50
10.12.6	2nd colour channel 1 - 4	51
10.12.7	Setting after flashing	51
10.12.8	Setting after flashing — Brightness value of all channels.....	51
10.12.9	Setting after flashing — Brightness value channel 1 - 4.....	52
10.13	Communication objects	53
10.13.1	Switching — Switch ON/OFF (SOO)	53
10.13.2	Dimming — Relative Setvalue Control (RSC)	53
10.13.3	Dimming — Absolute Setvalue Control (ASC).....	53
10.13.4	Status — Info ON/OFF (IOO).....	54
10.13.5	Status — Actual Dimming Value (ADV).....	54
10.13.6	Status — Output Overload Detection (OVL).....	54
10.13.7	Status — Output Over Temperature Detection.....	54
10.13.8	Setpoint control — Value RGB	55
10.13.9	Scene control — Input Scene Number (SN).....	55
10.13.10	Scene control — Input Scene Control (SC).....	55
10.13.11	Colour cycle control — Start/Stop Color Cycle.....	55
10.13.12	Colour cycle control — Color cycle speed control	55
10.13.13	Sequence control — Start/Stop sequence.....	56
10.13.14	Flashing control — Start/Stop flashing	56
11	Notes.....	57
12	Index	58

1 Notes on the instruction manual

Please read through this manual carefully and observe the information it contains. This will assist you in preventing injuries and damage to property, and ensure both reliable operation and a long service life for the device.

Please keep this manual in a safe place.

If you pass the device on, also pass on this manual along with it.

ABB accepts no liability for any failure to observe the instructions in this manual.

If you require additional information or have questions about the device, please contact ABB or visit our Internet site at:

www.BUSCH-JAEGER.com

2 Safety

The device has been constructed according to the latest valid regulations governing technology and is operationally reliable. It has been tested and left the factory in a technically safe and reliable state.

However, residual hazards remain. Read and adhere to the safety instructions to prevent hazards of this kind.

ABB accepts no liability for any failure to observe the safety instructions.

2.1 Information and symbols used

The following Instructions point to particular hazards involved in the use of the device or provide practical instructions:



Danger

Risk of death / serious damage to health

- The respective warning symbol in connection with the signal word "Danger" indicates an imminently threatening danger which leads to death or serious (irreversible) injuries.



Warning

Serious damage to health

- The respective warning symbol in connection with the signal word "Warning" indicates a threatening danger which can lead to death or serious (irreversible) injuries.



Caution

Damage to health

- The respective warning symbol in connection with the signal word "Caution" indicates a danger which can lead to minor (reversible) injuries.



Attention

Damage to property

- This symbol in connection with the signal word "Attention" indicates a situation which could cause damage to the product itself or to objects in its surroundings.



NOTE

This symbol in connection with the word "Note" indicates useful tips and recommendations for the efficient handling of the product.

2.2 Intended use

The device is a bus-capable 4-channel dimmer for operation on the KNX bus.

The device is intended for the following:

- Operation of LED lamps which are operated voltage-controlled
- Operation with RGB lamps, e.g. for colour illumination and pre-programmed colour sequences
- Operation according to the listed technical data
- Installation in dry interior rooms
- Use with the connecting options available on the device

The intended use also includes adherence to all specifications in this manual.

Extensive functions are available for the movement detectors. The range of applications is contained in Chapter 10 "Description of application and parameters" on page 19 (only in languages of the countries DE, EN, ES, FR, IT and NL).

The integrated bus coupler makes possible the connection of a KNX bus line.

2.3 Improper use

Each use not listed in Chapter 2.2 "Intended use" on page 7 is deemed improper use and can lead to personal injury and damage to property.

ABB is not liable for damages caused by use deemed contrary to the intended use of the device. The associated risk is borne exclusively by the user/operator.

The device is not intended for the following:

- Unauthorized structural changes
- Repairs
- Outdoor use
- The use in bathroom areas
- Insert with an additional bus coupler

2.4 Target group / Qualifications of personnel

Installation, commissioning and maintenance of the device must only be carried out by trained and properly qualified electrical installers.

The electrical installer must have read and understood the manual and follow the instructions provided.

The electrical installer must adhere to the valid national regulations in his/her country governing the installation, functional test, repair and maintenance of electrical products.

The electrical installer must be familiar with and correctly apply the "five safety rules" (DIN VDE 0105, EN 50110):

1. Disconnect
2. Secure against being re-connected
3. Ensure there is no voltage
4. Connect to earth and short-circuit
5. Cover or barricade adjacent live parts

2.5 Safety instructions



Caution! - Risk of damaging the device due to external factors!

Moisture and contamination can damage the device.

- Protect the device against humidity, dirt and damage during transport, storage and operation.

3 Information on protection of the environment

All packaging materials and devices bear the markings and test seals for proper disposal. Always dispose of the packaging material and electric devices and their components via the authorized collecting depots and disposal companies.

The products meet the legal requirements, in particular the laws governing electronic and electrical devices and the REACH ordinance.

(EU Directive 2012/19/EU WEEE and 2011/65/EU RoHS)

(EU REACH ordinance and law for the implementation of the ordinance (EC) No.1907/2006).



Consider the protection of the environment!

Used electric and electronic devices must not be disposed of with domestic waste.

- The device contains valuable raw materials which can be recycled. Therefore, dispose of the device at the appropriate collecting depot.

4 Setup and function

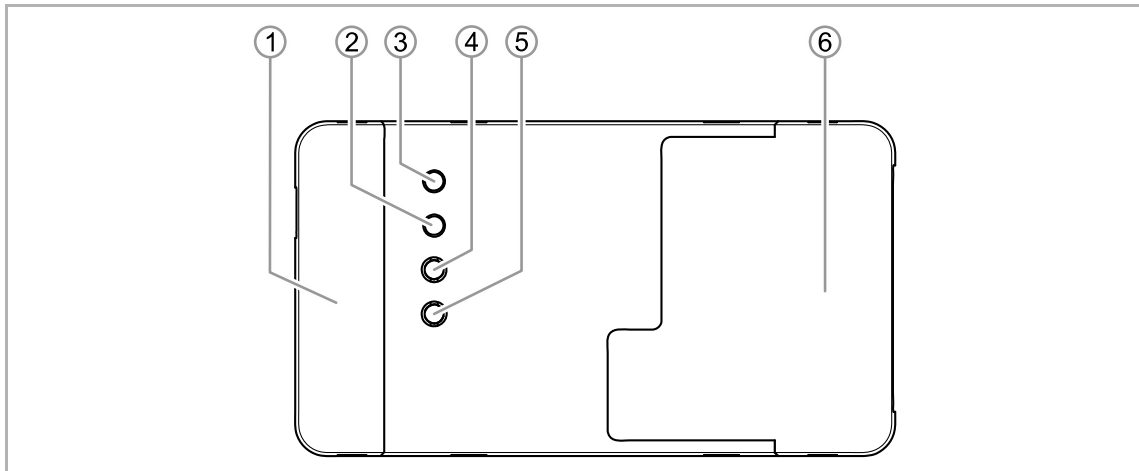

Fig. 1: Product overview

- [1] Side cover input
- [2] Test button
- [3] KNX programming button input
- [4] Status LED output (RGBW - LED channel)
- [5] Status LED (green = OK, red = error)
- [6] Side cover output

The device is a bus-capable dimmer. It is used for the control of LED lamps with a voltage range of 12 V to 24 V.

The device has four independent constant voltage outputs (CV), which are activated via the KNX bus. The device can also be operated with multi-channel lamps, e.g. for implementing colour illumination.

The device must not be used with other loads. The specified maximum values must not be exceeded.

4.1 Features of function and equipment

The following functions can be used for lighting control:

- On/Off per channel
- Status 1 bit and/or 1 byte per channel
- Absolute dimming
- Relative dimming
- 4 colour cycles
- 64 scenes
- 5 freely selectable sequences with up to 16 scenes



NOTE

For a detailed description of functions, see chapter 10 "Description of application and parameters" on page 19

4.2 Device overview

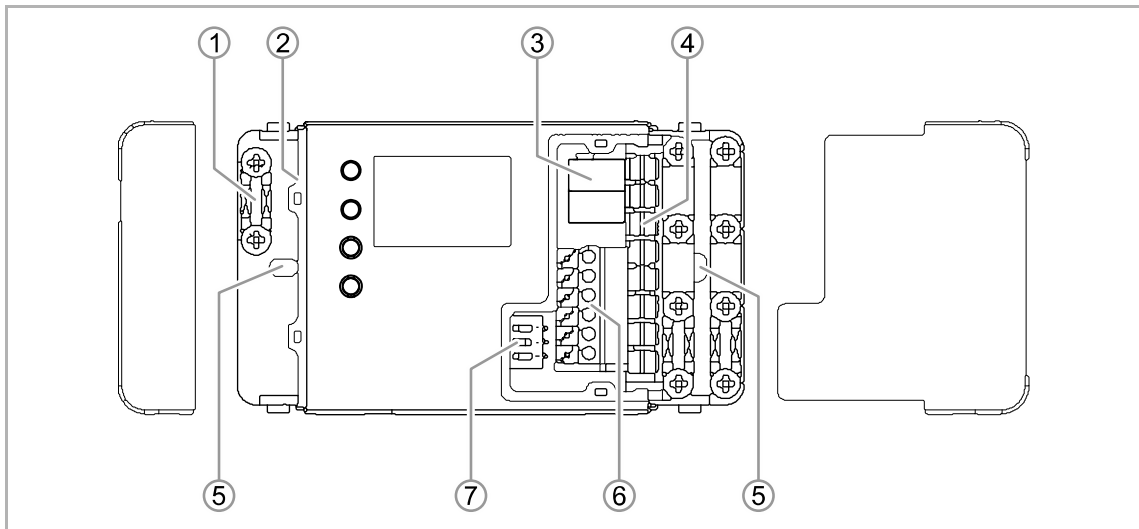

Fig. 2: Overview of devices

- [1] Cable strain relief
- [2] Input 12 V - 24 V DC "±"
- [3] KNX bus terminal "±"
- [4] RGBW LED output
- [5] Mounting holes
- [6] 2 x EOS- bus terminals "±", GND
- [7] DIP switch EOS

5 Technical data

5.1 Technical data

Designation		Value
Input	Power Supply	12 V to 24 V DC (via a separate power adaptor)
	KNX power consumption	Max. 12 mA
	Bus subscribers	1 (12 mA)
	KNX transmission rate	9600 Bps
Output	Output voltage	12 V to 24 V DC (constant voltage)
	Output current, maximum	2.5 A / channel
	Output load	4 x 2.5 A (10 A max.)
	Output power	0 to 240 W
	Output signal	PWM / 600 Hz
Connection	KNX	Bus connection terminal
	Cross-section input	0.75 - 1.5 mm ² , cage clamp terminal, single-wire
	Cross-section output	0.75 - 2.5 mm ² , cage clamp terminal, single-wire
Cable length, maximum	Dimmers <> Loads	350 m
	Loads <> Loads	700 m
	Dimmer <> Dimmer	200 m
	Total cable length	1000m
Reverse polarity protection	No	No Reversing of polarity can irreversibly destroy the load!
Overload protection	Yes	
Overheating protection	Yes	
Protection	IP20	
Dimensions (W x H x D)		95 mm x 33 mm x 53 mm
Operating temperature		-5°C - +45°C
Ambient temperature		-20°C - +50°C
Storage temperature		-20°C - +70°C

Table 1: Technical data

5.2 Dimensional drawings

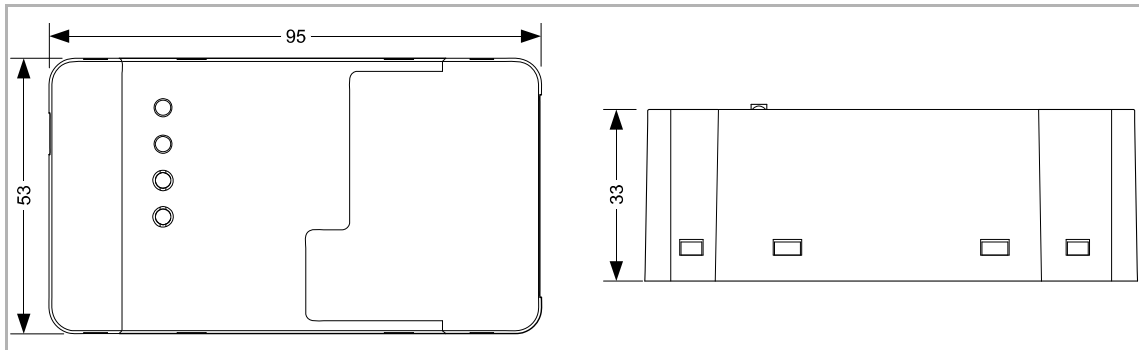

Fig. 3: Dimensions (all dimensions are in mm)

6 Connection and mounting

6.1 Installation site

They may only be installed in dry interior rooms.
Do not install next to heat sources. Adhere to a minimum distance of 20 cm!

6.2 Electrical connection

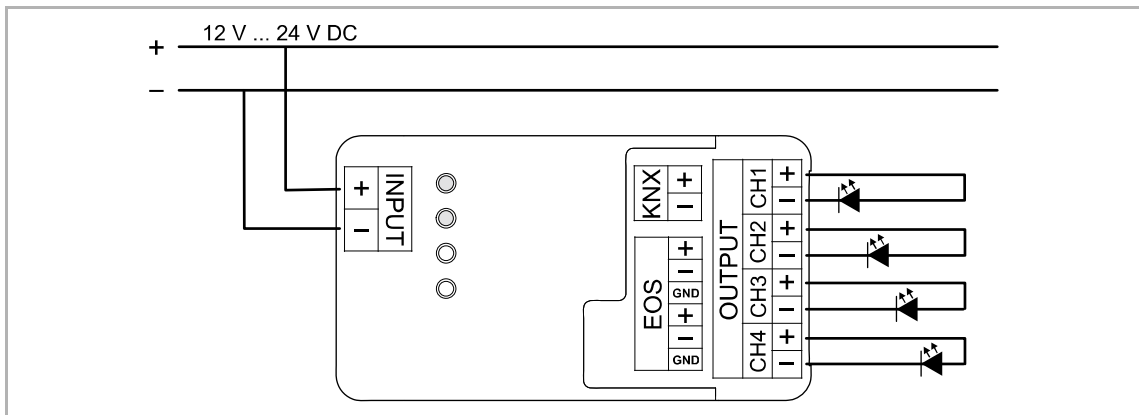

Fig. 4: Electrical connections

INPUT	Input 12 V to 24 V DC "±" via clamps
KNX	Input bus clamps "±"
OUTPUT (COM+)	RGB / RGBW / RGB + W / max. 4 x W
	CH1 = red CH2 = green CH3 = blue CH4 = white
EOS	2 x EOS bus clamps "±", GND

Table 2: Electrical connections



Attention – Destruction of connected load!

Reversing the polarity of the electrical connection can irreversibly destroy the load.

The voltages on the KNX and primary side must conform to the SELV regulations.

- Observe the correct polarity of the supply voltage when connecting the device.

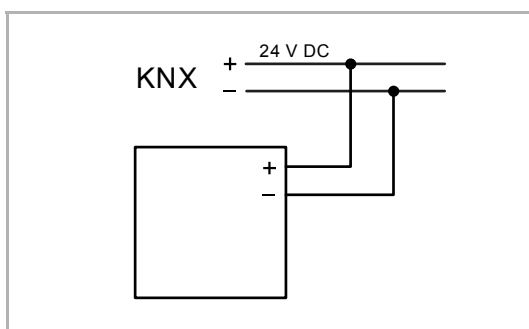

Fig. 5: Connection of bus coupler

Carry out the electrical connection according to the circuit diagram.

7 Commissioning

7.1 Software

To start the device a physical address must be assigned first. The physical address is assigned and the parameters are set with the Engineering Tool Software (ETS).



NOTE

The devices are products of the KNX system and meet KNX guidelines. Detailed expert knowledge by means of KNX training sessions for a better understanding is assumed.

7.1.1 Preparation

1. Connect a PC to the KNX bus line via the KNX interface, e.g. via the commissioning interface / the commissioning adapter 6149/21-500).
 - The current Engineering Tool Software must be installed on the PC (ETS 4.2 or higher).
2. Switch on the bus voltage.

7.1.2 Assigning a physical address



NOTE

Please observe the operating manual for the flush-mounted bus/network coupler which is to be ordered separately.

7.1.3 Assigning the group address(es)

The group addresses are assigned in connection with the ETS.

7.1.4 Selecting the application program

Please contact our Internet support unit (www.BUSCH-JAEGER.com). The application is loaded into the device via the ETS.

7.1.5 Differentiating the application program

Various functions can be implemented via the ETS.

Detailed description of parameters, see chapter 10 “Description of application and parameters“ on page 19.

8 Operation

8.1 Control elements

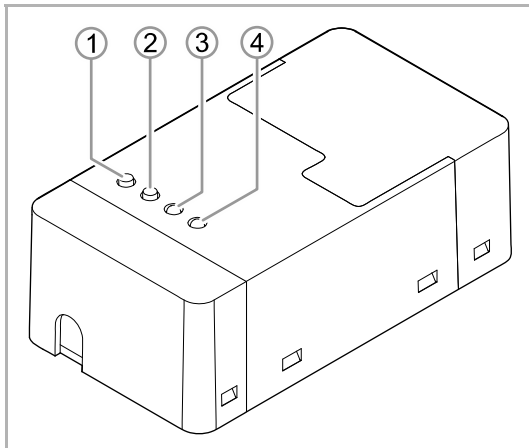

Fig. 6: Control elements

- [1] Programming button
- [2] Test button
- [3] Status-LED output
- [4] Status-LED programming mode

The device can be addressed with the programming button [1] via the KNX bus in the system.

The status LED [3] indicates the condition at the outputs (RGBW – channel LED).

The status LED [4] indicates whether the programming mode is active:

- Green = OK
- Red = Error

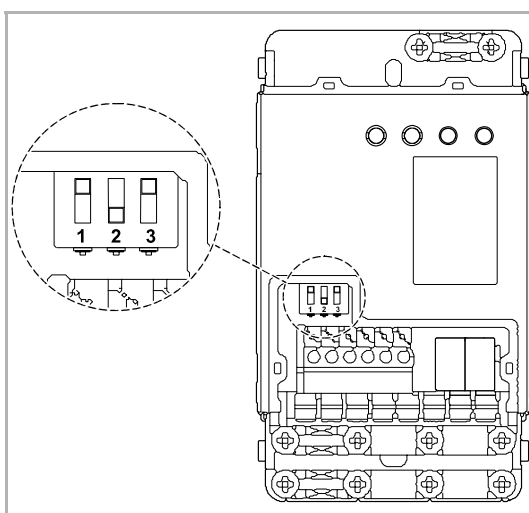

Fig. 7: Dip switch

- DIP switch:
- 1 EOS termination
 - 2 Reserve
 - 3 EOS master

8.2 Operating statuses

Behaviour at failure of bus voltage

The device is inactive and cannot be controlled. The last operating status at the outputs is saved.

Behaviour at return of bus voltage

The device is initialized (can take a certain amount of time). During the initialization all four outputs are in succession briefly activated and then deactivated again.

You can set the behaviour of the device at the return of bus voltage in the application "Bus-voltage failure/return parameters", see chapter 10.7 "Application "Bus voltage failure/return parameters"" on page 36.

- Last brightness set
- All channels 100%
- All channels 0%
- All channels via 1 parameter
- Parameters per channel

Behaviour at failure of supply voltage

The control and the bus communication of the KNX actuator remain active. The connected LED lamps are switched off.

Behaviour at return of supply voltage

You can adjust the behaviour of the device at return of the supply voltage in application "Status parameter" / "Storage of current status after 5 min", see chapter 10.4 "Application "Status parameters"" on page 24.

9 Maintenance

9.1 Cleaning



Caution! - Risk of damaging the device!

- When spraying on cleaning agents, these can enter the device through crevices.
 - Do not spray cleaning agents directly onto the device.
- Aggressive cleaning agents can damage the surface of the device.
 - Never use caustic agents, abrasive agents or solvents.

Clean dirty devices with a soft dry cloth.

- If this is insufficient, the cloth can be moistened slightly with a soap solution.

9.2 Maintenance-free device

The device is maintenance-free. In case of damage, e.g. during transport or storage), do not perform repairs. Once the device is opened, the warranty is void.

Access to the device must be guaranteed for operation, testing, inspection, maintenance and repairs (according to DIN VDE 0100-520).

10 Description of application and parameters

10.1 Application program

The current Engineering Tool Software (ETS 4.2 or higher) is required to program the device. The current version and the product database can be downloaded via the e-catalogue (www.busch-jaeger-catalogue.com).

The application program is the basic program for the use of the device. It contains the applications for the control of the outputs.

The following application program is available for the LED dimmer.

Application program
ABB LED-Dimmer CV

The application program contains the following KNX applications:

KNX applications	
Switching	Colour cycle
Dimming	Sequences
Scenes	Flashing

Depending on which device and application are selected, the Engineering Tool Software (ETS) shows different parameters and communication objects. This allows the device to be set accordingly with multiple functions.

The functions and parameters described in the following sections always refer to all outputs. The outputs are not described separately.

10.2 Overview of functions

Application	Parameter	Options
Global parameters	Number of channels	1 ... 4
	Minimum value	1 ... 254
	Maximum value	2 ... 255
	Dimming process	Linear Square Logarithmic
Status parameters	Message of the switching state	Yes / No
	Message of the brightness value	Yes / No
	Minimum change of the brightness value before it is sent	1 .. 25 %
	Activate error feedback signal	Yes / No
	Saving the current status after 5 min.	Yes / No

Switching parameters	Activation with	Last brightness
		Defined brightness
	Brightness value after the ON command	0 ... 255
	Delay before leaving OFF	0 ... 65535 10 ms
	Delay before the onset of OFF	0 ... 65535 10 ms
	Activation	Via dimming
		Via jump
	Dimming speed at ON command	1 ... 65535 s
Dimming speed at OFF command	1 ... 65535 s	
Dimming parameters	Dimming mode selection for absolute value	Via dimming
		Via jump
	Absolute dimming speed by	Parameter via BUS
		Parameter via ETS
	Absolute dimming speed	1 ... 65535 s
	Relative dimming speed by	Parameter via BUS
		Parameter via ETS
Relative dimming speed	1 ... 65535 s	
Permit relative OFF	Yes / No	
Bus voltage failure/return parameters	Bus voltage return Message delay	0 ... 65535 10 ms
	Selection of bus voltage return value	Previously set colour
		All channels 100%
		All channels 0%
		All channels via 1 parameter
		Parameters per channel
	Bus voltage return value all channels	0 ... 255
	Bus voltage return value channel 1 - 4	0 ... 255
	Selection of bus voltage failure value	Previously set colour
		All channels 100%
All channels 0%		
All channels via 1 parameter		
Parameters per channel		
Bus voltage failure value all channels	0 ... 255	
Bus voltage failure value channel 1 - 4	0 ... 255	
Special functions	Activate scenes	Yes / No

Description of application and parameters

Overview of functions

	Activate scene control	Yes / No
	Activate colour cycle	Yes / No
	Activate sequence	Yes / No
	Activate flashing control	Yes / No
Scene parameters	Scene for parameter adjustment	Scene 0 ... scene 63
	Activate channel 1 - 4	Yes / No
	Channel 1 ... 4	0 ... 255
	Scene control of all parameters	Activating all channels at once
Colour cycle parameters	Colour cycle dimming speed via	Parameter via BUS
		Parameter via ETS
	Function of the RGBW colour cycle	Colour cycle RGB
		Colour cycle RGBW
		Colour cycle RGB + W
		Colour cycle white emotion
	Length of the colour cycle (RGB+W)	20 ... 65535 s
	Length of the colour cycle (RGB)	15 ... 65535 s
	Length of the colour cycle WE (White Emotion)	10 ... 65535 s
	Setting after the colour cycle	Current colour
		Previous colour
		All channels 0%
		All channels 100%
Parameters per channel		
All channels via 1 parameter		
Brightness value of all channels	0 ... 255	
Brightness value of channel 1 - 4	0 ... 255	
Sequence parameters	Activate sequence 1 - 5	Yes / No
	Number of scenes in sequence 1 - 5	Scenes 2 ... 16
	Activate channel 1 - 4	Yes / No
	Setting after stop of the sequence	Current colour
		Previous colour
		All channels 0%
		All channels 100%
Parameters per channel		
All channels via 1 parameter		

	Brightness value of all channels	0 ... 255	
	Brightness value of channel 1 - 4	0 ... 255	
	Channel 1 ... 4	0 ... 255	
	Time in the scene	0 ... 255 s	
	Time for dimming to the next scene	0 ... 255 s	
Flashing parameters	Number of flashes	0 ... 65535	
	Flashing ON-time (1st colour)	1 ... 65535 10 ms	
	Flashing OFF-time (2nd colour)	1 ... 65535 10 ms	
	1st colour channel 1 ... 4	0 ... 255	
	2nd colour with	Preferred colour	
		Previous colour	
	2nd colour channel 1 ... 4	0 ... 255	
	Setting after flashing	Current colour	
		Previously set colour	
		All channels 0%	
		All channels 100%	
		All channels via 1 parameter	
	Parameters per channel		
Brightness value of all channels	0 ... 255		
Brightness value of channel 1 - 4	0 ... 255		

Table 3: Overview of functions

10.3 Application "Global parameters"

10.3.1 KNX LED dimmer to be programmed

Options: Display only

Display of name of LED dimmer being programmed.

10.3.2 Number of channels

Options: Setting option from 1 - 4

Setting the number of channels and available communication objects.

The channel allocation is displayed in the ETS: "Output (1 - 4) is controlled by".

Number of channels	Channel 1 =	Channel 2 =	Channel 3 =	Channel 4 =
1	White	White	White	White
2	Warm white	Cold white	Warm white	Cold white
3	Red	Green	Blue	Deactivated
4	Red	Green	Blue	White

Table 4: Number of channels and their allocation

10.3.3 Minimum value (MIN)

Options: Setting option from 1 - 254

Setting the minimum dimming value.

The maximum value must always be higher than the minimum value ($MAX > MIN$). In case of an incorrect entry the maximum value is set on the dimmer and the minimum value is recalculated:
 $MIN = MAX - 1$

10.3.4 Maximum value (MAX)

Options: Setting option from 2 - 255

Setting the maximum dimming value.

The maximum value must always be higher than the minimum value ($MAX > MIN$). In case of an incorrect entry the maximum value is set on the dimmer and the minimum value is recalculated:
 $MIN = MAX - 1$

10.3.5 Dimming procedure

Options:	Linear
	Square
	Logarithmic

The brightness path can be adjusted to the human eye with the selection of a dimmer curve.

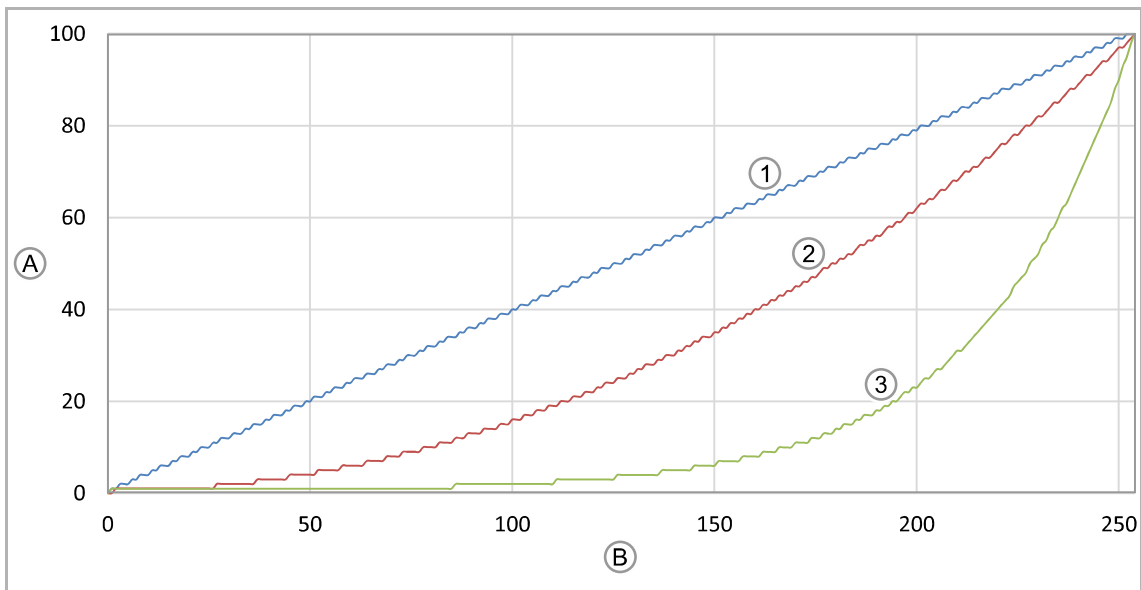

Fig. 8: Comparison of dimming curves

[A] Luminosity in percent (%)

[B] 8 bit dimming value

[1] Linear

[2] Square

[3] Logarithmic

10.4 Application "Status parameters"

10.4.1 Message of the switching state

Options:	Yes
	No

The parameter is used to specify whether the additional object for the feedback signal of the switching state is activated for all outputs.

If an external display is connected, the feedback signal can be used to show the switching state on the display. The outputs are displayed individually.

10.4.2 Message of the brightness value

Options:	Yes
	No

The parameter is used to specify whether the additional object for the feedback signal of the brightness value is activated for all outputs.

If an external display is connected, the feedback signal can be used to show the brightness value on the display. The outputs are displayed individually.

10.4.3 Minimum change of the brightness value before it is sent

Options:	Setting option from 1 - 25%
----------	-----------------------------

The parameter is used to specify how often the brightness value is sent to the bus. The brightness value is sent all X-values both when reaching the "Min/Max set value" and when reaching the setpoint.

So as not to overload the bus for a colour cycle/sequence, select a high value.

Examples	
1 %	Every value is sent
2 %	Every 5th value is sent
5 %	Every 13th value is sent
25 %	Every 64th value is sent

Table 5: Values during sending of brightness

**NOTE**

This parameter is only adjustable if the parameter "Message of brightness value" is set on "Yes".

10.4.4 Activate error feedback signal

Options:	Yes
	No

The message of errors (excess temperature and overload) can be activated on the KNX bus via the parameter.

10.4.5 Saving the current status after 5 min.

Options:	No
	Yes

The parameter can be used to specify whether the device jumps to the last valid status (ON/OFF/SEQUENCE/COLOR CYCLE) after a power failure.

The last valid status must be on the device for at least 5 minutes.

10.5 Application "Switching parameters"

10.5.1 Activation with

Options:	Last brightness
	Defined brightness

The parameter is used to specify the brightness value that is to be set after the ON command.

- *Last brightness*: The brightness before the OFF command is set.
- *Defined brightness*: The brightness that is set via parameter "Brightness value after the ON command" is set.

10.5.2 Brightness value after the ON command

Options:	Setting option from 0 - 255
----------	-----------------------------

The brightness value is set after the ON command.

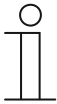

NOTE

The parameter is only adjustable if the "Activation with" parameter is set on "Defined brightness".

10.5.3 Delay before leaving OFF

Options: Setting option from 0 - 65535 10 ms

This parameter is used to set the switching-on delay.

– 0: No switch-on delay. The setpoint is reached immediately.

The delay time can be set in steps of 10 milliseconds (ms).

Adjustment tool:

Value	Milliseconds	Seconds	Minutes
1	10	-	-
5	50	-	-
10	100	-	-
100	1000	1	-
500	5000	5	-
3000	30000	30	$\frac{3}{4}$
6000	60000	60	1
30000	300000	300	5
...
65535	655350	655	11

Table 6: Delay before leaving OFF (time table)

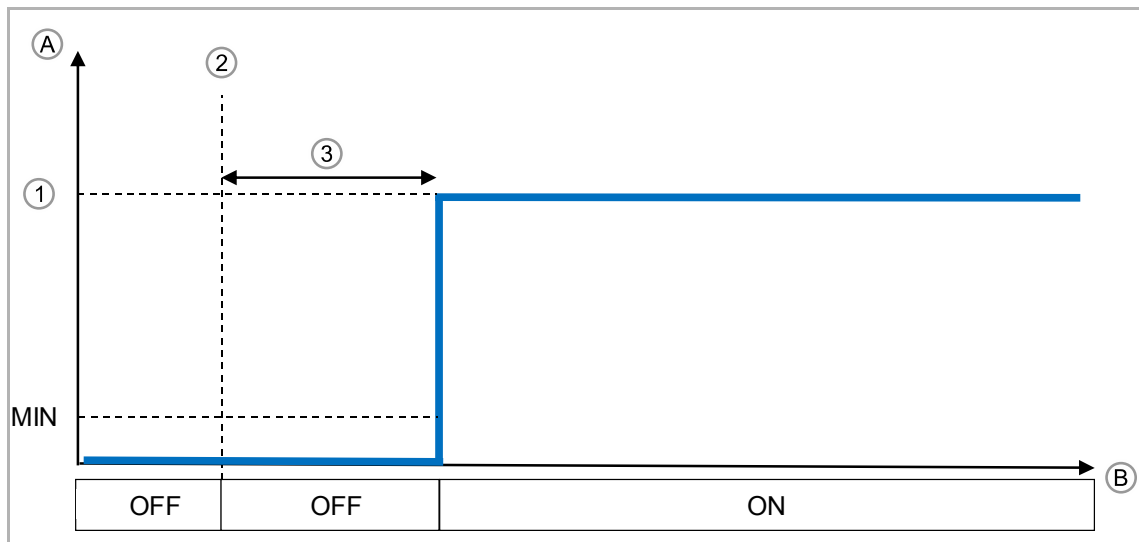

Fig. 9: Delay before leaving OFF

[A] Signal level at output

[B] Time (t)

[1] Setpoint

[2] ON signal

[3] Delay

10.5.4 Delay before the onset of OFF

Options: Setting option from 0 - 65535 10 ms

This parameter is used to set the switch-off delay.

– 0: No switch-off delay. The setpoint is reached immediately.

The delay time can be set in steps of 10 milliseconds (ms).

Adjustment tool:

Value	Milliseconds	Seconds	Minutes
1	10	-	-
5	50	-	-
10	100	-	-
100	1000	1	-
500	5000	5	-
3000	30000	30	$\frac{3}{4}$
6000	60000	60	1
30000	300000	300	5
...
65535	655350	655	11

Table 7: Delay before onset of OFF (time table)

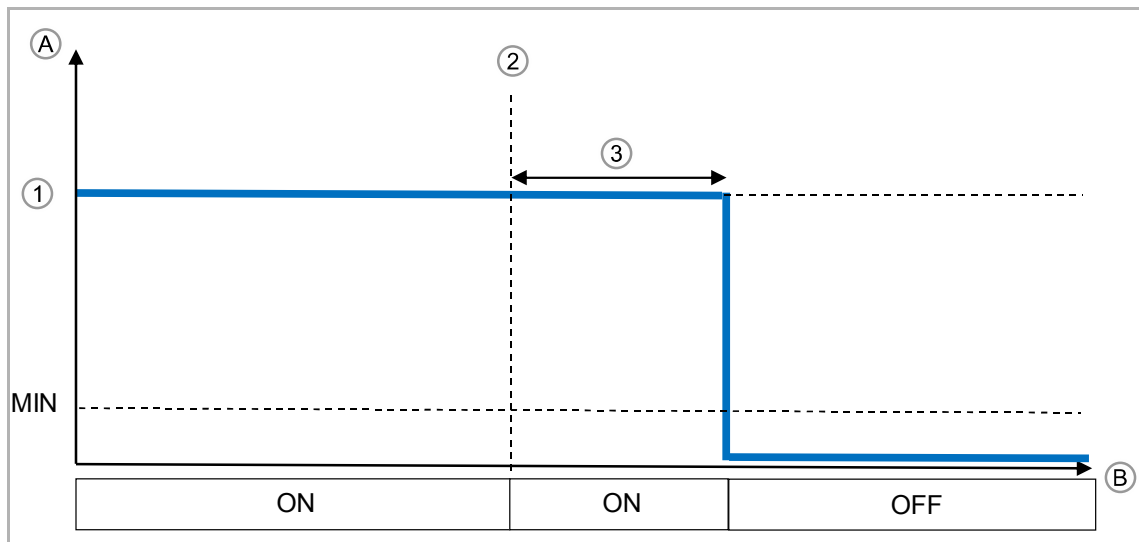

Fig. 10: Delay before the onset of OFF

[A] Signal level at output

[B] Time (t)

[1] Setpoint

[2] Off signal

[3] Delay

10.5.5 Activation

Options:	Via dimming
	Via jump

The parameter is used to specify whether the KNX LED dimmer jumps to the setpoint or dims at the ON command.

If the parameter is set on "Via dimming", the parameters "Dimming speed at ON command" and "Dimming speed at OFF command" can be set separately.

10.5.6 Activation - Dimming speed at ON command

Options:	Setting option from 1 - 65535 s (approx. 18.2 h)
----------	--

This parameter is used to set the dimming time up to reaching the switch-on setpoint.



NOTE

The parameter is only adjustable if the "Switch-on" parameter is set on "Via dimming".

Adjustment tool:

Seconds	Minutes	Hours
30	½	
60	1	
120	2	
300	5	
600	10	
900	15	
1800	30	½
2700	45	¾
3600	60	1
4800	90	1 ½
7200	120	2
10800	180	3
14400	240	4
18000	300	5
...
64800	1080	18

Table 8: Dimming speed at ON command (time table)

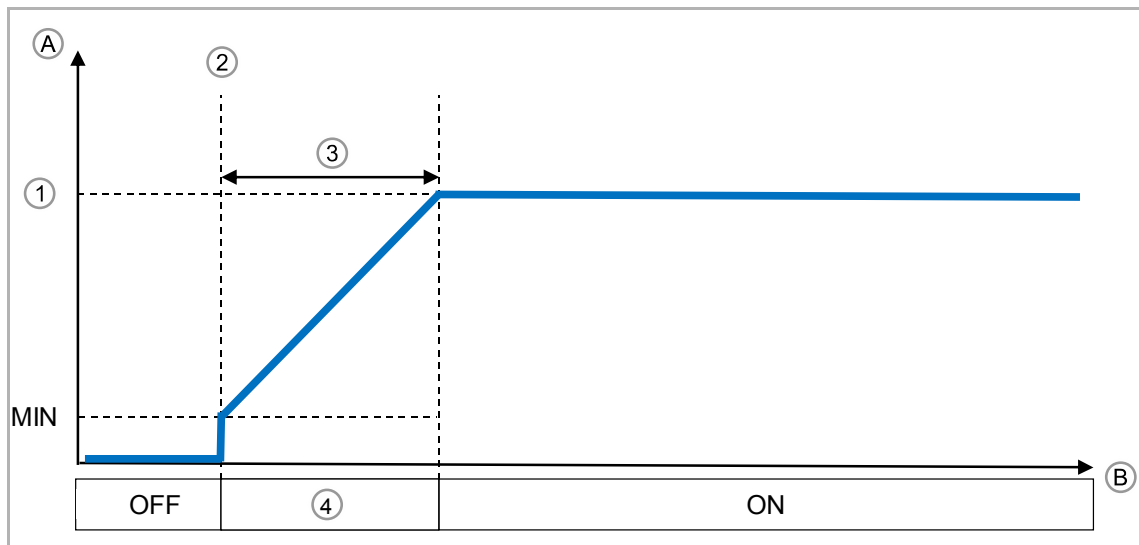

Fig. 11: Dimming speed: at ON command

- [A] Signal level at output
- [B] Time (t)
- [1] Setpoint
- [2] ON signal
- [3] Dimming time
- [4] DIMMING

10.5.7 Activation - Dimming speed at OFF commandOptions: Setting option from 1 - 65535 s (approx. 18.2 h)

This parameter is used to set the dimming time up to reaching the switch-off.

**NOTE**

The parameter is only adjustable if the "Switch-on" parameter is set on "Via dimming".

Adjustment tool:

Seconds	Minutes	Hours
30	½	
60	1	
120	2	
300	5	
600	10	
900	15	
1800	30	½
2700	45	¾
3600	60	1
4800	90	1 ½
7200	120	2
10800	180	3
14400	240	4
18000	300	5
...
64800	1080	18

Table 9: Dimming speed at OFF command (time table)

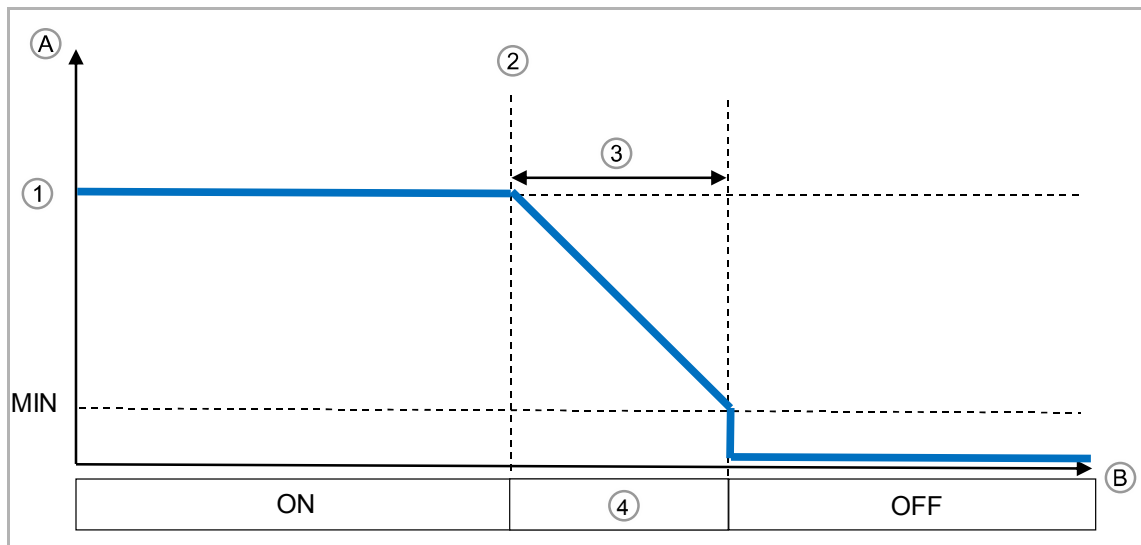

Fig. 12: Dimming speed: at OFF command

- [A] Signal level at output
- [B] Time (t)
- [1] Setpoint
- [2] OFF signal
- [3] Dimming time
- [4] DIMMING

10.5.8 Activation with delay and dimming

The two functions "Delay before leaving OFF" and Dimming speed at ON command" can be combined.

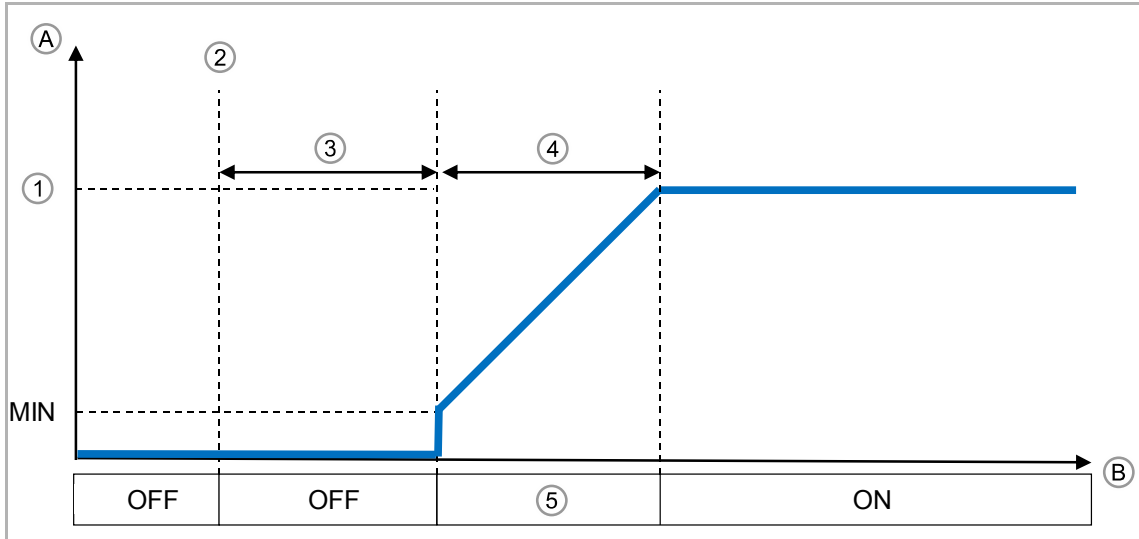

Fig. 13: Delay at activation and dimming to setpoint

- [A] Signal level at output
- [B] Time (t)
- [1] Setpoint
- [2] ON signal
- [3] Delay
- [4] Dimming time
- [5] DIMMING

10.5.9 Switch-off with delay and dimming

The two functions "Delay before onset of OFF" and Dimming speed at OFF command" can be combined.

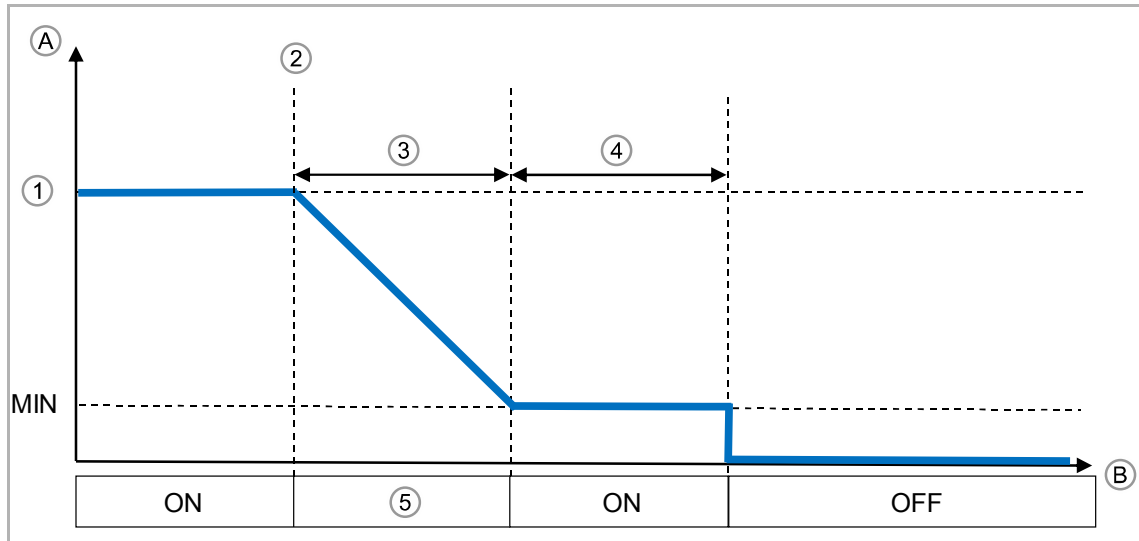

Fig. 14: Dimming and delay at switch-off

[A] Signal level at output

[B] Time (t)

[1] Setpoint

[2] OFF signal

[3] Dimming time

[4] Delay

[5] DIMMING

10.6 Application "Dimming parameters"

10.6.1 Dimming mode selection for absolute value

Options:	Via dimming
	Via jump

When an absolute value has been set, it can neither be jumped nor dimmed to this setpoint.

If "Via dimming" is selected, the dimming speed for the absolute value can be set (parameter "Absolute dimming speed by" and "Absolute dimming speed").

10.6.2 Dimming mode selection for absolute value — Absolute dimming speed by

Options:	Parameter via BUS
	Parameter via ETS

The dimming speed can be set either via the bus with communication object "25: dimming speed" or directly in the ETS.

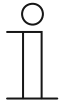

NOTE

The parameter is only adjustable if the "Dimming mode selection for absolute value" parameter is set on "Via dimming".

10.6.3 Dimming mode selection for absolute value — Absolute dimming speed

Options:	Setting option from 1 - 65535 s
----------	---------------------------------

This parameter is used to set the dimming time by setting an absolute value.



NOTE

The parameter is only adjustable if the "Absolute dimming speed by" parameter is set on "Parameter via ETS".

Adjustment tool:

Seconds	Minutes	Hours
30	½	
60	1	
120	2	
300	5	
600	10	
900	15	
1800	30	½
2700	45	¾
3600	60	1
4800	90	1 ½
7200	120	2
10800	180	3
14400	240	4
18000	300	5
...
64800	1080	18

Table 10: Absolute dimming speed (time table)

10.6.4 Relative dimming speed by

Options:	Parameter via BUS
	Parameter via ETS

The dimming speed can be set either via the bus with communication object "26: dimming speed" or directly in the ETS.

10.6.5 Relative dimming speed

Options:	Setting option from 1 - 65535 s
----------	---------------------------------

This parameter is used to set the dimming time for relative dimming.



NOTE

The parameter is only adjustable if the "Relative dimming speed by" parameter is set on "Parameter via ETS".

10.6.6 Permit relative OFF

Options:	Yes
	No

If option "Yes" has been selected, the LED dimmer can be switched off via the communication object for relative dimming.

10.7 Application "Bus voltage failure/return parameters"

10.7.1 Bus voltage return Message delay

Options:	Setting option from 0 - 65535 10 ms
----------	-------------------------------------

To ensure that not all devices start sending simultaneously at the return of bus voltage (BUS overload possible), a delay for sending can be set via the parameter.

- 0: No delay. Message is sent immediately.

10.7.2 Selection of bus voltage return value

Options:	Previously set colour
	All channels 100%
	All channels 0%
	All channels via 1 parameter
	Parameters per channel

The parameter is used to set the behaviour at the return of bus voltage.

- *Previously set colour*: The previously set colour is set for each channel.
- *All channels 100%*: All channels are set at 100% (On).
- *All channels 0%*: All channels are set at 0% (Off).
- *All channels via 1 parameter*: All channels are set via one parameter ("Bus voltage return value all channels").
- *Parameters per channel*: Each channel is set via its own parameter ("Bus voltage return value channel 1 - 4").

10.7.3 Selection of bus voltage return value — Bus voltage return value of all channels"

Options:	Setting option from 0 - 255
----------	-----------------------------

The parameter is used to set the setpoint on all channels after a bus voltage return.



NOTE

The parameter is only adjustable if the "Selection of bus voltage return value" parameter is set on "All channels via 1 parameter".

10.7.4 Selection of bus voltage return value — Bus voltage return value channel 1 - 4

Options:	Setting option from 0 - 255
----------	-----------------------------

The parameter is used to set the setpoint on each individual channel after a bus voltage return.



NOTE

The parameter is only adjustable if the "Selection of bus voltage return value" parameter is set on "Parameter per channel".

10.7.5 Selection of bus voltage failure value

Options:	Previously set colour
	All channels 100%
	All channels 0%
	All channels via 1 parameter
	Parameters per channel

The parameter is used to set the behaviour at bus voltage failure.

- *Previously set colour*: The previously set colour is set for each channel.
- *All channels 100%*: All channels are set at 100% (On).
- *All channels 0%*: All channels are set at 0% (Off).
- *All channels via 1 parameter*: All channels are set via one parameter ("Bus voltage failure value all channels").
- *Parameters per channel*: Each channel is set via its own parameter ("Bus voltage failure value channel 1 - 4").

10.7.6 Selection of bus voltage failure value - Bus voltage failure value all channels

Options:	Setting option from 0 - 255
----------	-----------------------------

The parameter is used to set the setpoint on all channels after a bus voltage failure.



NOTE

The parameter is only adjustable if the "Selection of bus voltage failure value" parameter is set on "All channels via 1 parameter".

10.7.7 Selection of bus voltage failure value - Bus voltage failure value channel 1 - 4

Options:	Setting option from 0 - 255
----------	-----------------------------

The parameter is used to set the setpoint on each individual channel after a bus voltage failure.



NOTE

The parameter is only adjustable if the "Selection of bus voltage failure value" parameter is set on "Parameter per channel".

10.8 Application "Special functions"

10.8.1 Activate scenes

Options:	Yes
	No

- Yes: Menu "Scene control" and communication object "29: scene number" are activated.

10.8.2 Activate scenes - Activate scene control

Options:	Yes
	No

- Yes: Scenes are stored via a push-button. Communication object "30: scene control" is activated.
- No: Communication object "30: scene control" is deactivated.



NOTE

The parameter is only adjustable if the "Activate scenes" parameter is set to "Yes".

10.8.3 Activate colour cycle

Options:	Yes
	No

- Yes: Menu "Colour cycle control" and communication object "31: colour cycle control" are activated.

10.8.4 Activate sequences

Options:	Yes
	No

- Yes: Menu "Sequence parameter" is activated.

10.8.5 Activate flashing control

Options:	Yes
	No

- Yes: Menu "Activate flashing control" and communication object "38: flashing control" are activated.

10.9 Application "Scene control"

In application "Scene control" the scenes are displayed and set individually. In application "Scene control of all parameters", all 64 scenes are listed with their parameters.

A brightness value/colour value can be entered for each channel of a scene.

Adjustment tool:





















Designation	Channel			Colour
	Red	Green	Blue	
Red	255	0	0	
Dark red	139	0	0	
Brick red	178	34	34	
Orchid	218	112	214	
Violet	238	130	238	
Green	0	255	0	
Dark green	0	100	0	
Spring green	0	255	127	
Green yellow	127	255	0	
Ocean green	32	178	170	
Blue	0	0	255	
Dark blue	0	0	139	
Royal blue	65	105	225	
Cyan	0	255	255	
Turquoise	64	224	208	
White	255	255	255	
Yellow	255	255	0	
Orange	255	165	0	
Bright pink	255	182	193	
Pink	255	20	147	

Table 11: Colour table for scenes

Additional colours and the associated RGB codes are available at:

www.uize.com/examples/sortable-color-table

10.9.1 Scene for parameter adjustment

Options:	Scene 0 ... scene 63
----------	----------------------

The parameter is used to select the scene that is set with parameter "Activate channel 1 - 4".

10.9.2 Activate channel 1 - 4

Options:	Yes
	No

The parameter is used to activate the channel in the selected scene.

If a channel is deactivated and the associated scene is called up, the current value of the deactivated channel is not changed.

10.9.3 Activate channel 1 - 4 — Channel 1 - 4 for activated scene

Options:	Setting option from 0 - 255
----------	-----------------------------

This parameter is used to set the value for the individual channels in the selected scene.

**NOTE**

The parameter is only adjustable if the "Activate channel 1 - 4" parameter is set to "Yes".

10.9.4 Scene control of all parameters

In menu "Scene control of all parameters", all 64 scenes are listed with their parameters. The parameters are the same as under "Activate channel 1 - 4".

A brightness value can be entered for each channel of a scene. Colour table, see chapter 10.9 "Application "Scene control"" on page 40.

10.10 Application "Colour cycle control"

The behaviour of the colour cycle is set in application "Colour cycle control". A different menu is displayed depending on the number of channels.

- The behaviour of the colour cycle can be set when four channels are used.
- When three channels are used, the colour cycle is set on RGB.
- When two channels are used, the colour cycle is set on "White Emotion".
- The colour cycle is deactivated if only one channel is used.

Setting the number of channels, see chapter 10.3.2 "Number of channels" on page 23

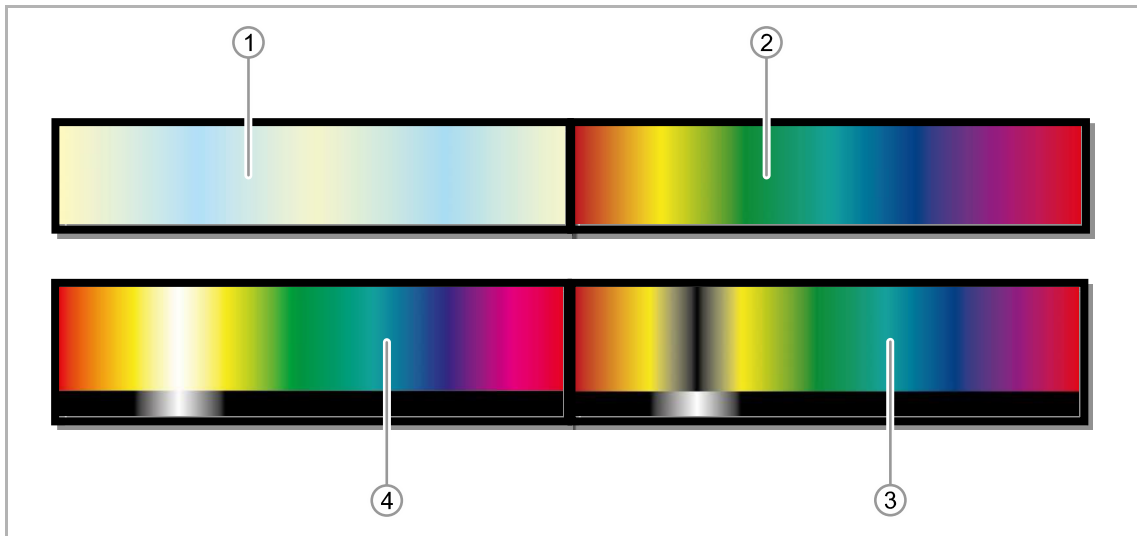

Fig. 15: Colour blending

- [1] White Emotion
- [2] RGB
- [3] RGB + W
- [4] RGBW

For RGB the white channel is admixed in addition to the additive mixed white. For RGB+W the white channel is used instead of the additive colour mix.



NOTE

Colour cycles can be dimmed up to 25% of the brightness. A colour cycle is stopped either via a master command or a colour cycle stop command.

10.10.1 Colour cycle dimming speed via

Options:	Parameter via BUS
	Parameter via ETS

The length of the colour cycle can be set either via the bus with communication object "32: colour cycle length" or directly in the ETS.

10.10.2 Function of the RGBW colour cycle

Options:	Colour cycle RGB
	Colour cycle RGBW
	Colour cycle RGB + W
	Colour cycle White Emotion

The parameter is used to set how the colour cycle is to operate with four channels.



NOTE

The parameter is only adjustable if the "Number of channels" parameter is set on "4" and parameter "Colour cycle dimming speed via" is set on "Parameter via ETS".

10.10.3 Length of the colour cycle (RGB)

Options:	Setting option from 15 - 65535 s
----------	----------------------------------

The parameter is used to set the duration of a colour cycle.

The setting option is dependent on the setting of parameter "Function of the RGBW colour cycle".

10.10.4 Length of the colour cycle (RGBW and RGB+W)

Options:	Setting option from 20 - 65535 s
----------	----------------------------------

The parameter is used to set the duration of a colour cycle.

The setting option is dependent on the setting of parameter "Function of the RGBW colour cycle".

10.10.5 Length of the colour cycle WE (White Emotion)

Options:	Setting option from 10 - 65535 s
----------	----------------------------------

The parameter is used to set the duration of a colour cycle.

The setting option is dependent on the setting of parameter "Function of the RGBW colour cycle".

10.10.6 Colour cycle description of functions

Options:	Display only
----------	--------------

Display of the active function of the colour cycle.

Setting the function under "Function of the RGBW colour cycle".

10.10.7 Setting after colour cycle stop

Options:	Current colour
	Previously set colour
	All channels 0%
	All channels 100%
	All channels via 1 parameter
	Parameters per channel

The parameter is used to set the behaviour at stop of colour cycle.

- *Current colour*: The current colour value is retained.
- *Previously set colour*: The previously set colour is set for each channel.
- *All channels 0%*: All channels are set at 0% (Off).
- *All channels 100%*: All channels are set at 100% (On).
- *All channels via 1 parameter*: All channels are set via one parameter ("Colour cycle stop brightness value all channels").
- *Parameters per channel*: Each channel is set via its own parameter ("Colour cycle stop brightness value channel 1 - 4").

10.10.8 Setting after colour cycle stop — Brightness value of all channels

Options:	Setting option from 0 - 255
----------	-----------------------------

The parameter is used to set the setpoint on all channels after colour cycle stop.



NOTE

The parameter is only adjustable if the "Setting after colour cycle stop" parameter is set on "All channels via 1 parameter".

10.10.9 Setting after colour cycle stop — Brightness value of channel 1 - 4

Options:	Setting option from 0 - 255
----------	-----------------------------

The parameter is used to set the setpoint on each individual channel after colour cycle stop.



NOTE

The parameter is only adjustable if the "Setting after colour cycle stop" parameter is set on "Parameters per channel".

10.11 Application "Sequence parameters"

In application "Sequence parameters" up to 5 sequences can be activated. Sequences are colour cycles that can be individually combined. Each sequence consists of 2 to 16 scenes. The active channels are set in the scenes. The colour and the time sequence of the individual colours can be set in the sequences.

A sequence is terminated either with a master command or with a stop command.



NOTE

The first scene of a sequence must contain a time value. If "0" is set, the sequence does not start. Only scenes with a time value of > 0 are called up.

10.11.1 Passage of time for a sequence

In this section a possible passage of time for a sequence and a channel are illustrated.

The individual times of the scenes are either 0 (no time) or 1 (time).

Scene	Channel 1	Time in the scene	Dimming time to the next scene
1	255	1	0
2	0	1	1
3	10	0	1
4	20	1	1
5	100	1	0

Table 12: Example for a passage of time in a sequence

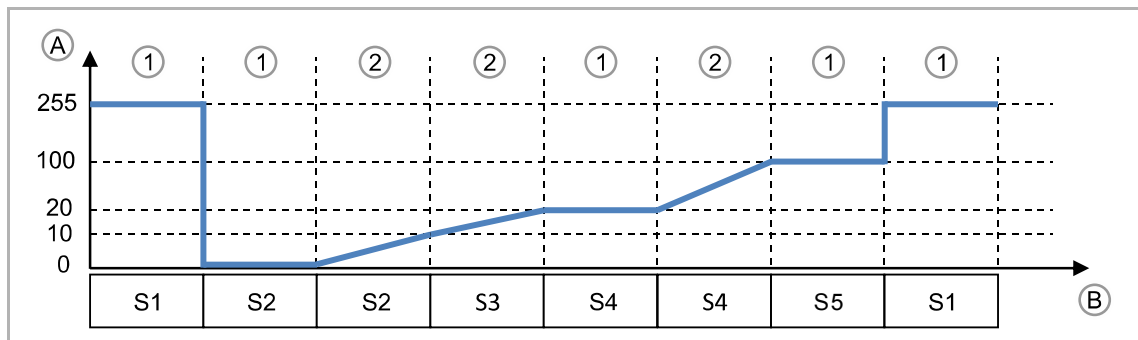

Fig. 16: Example for a passage of time in a sequence

[A] Channel 1

[B] Time

[S] Scene (S1 - S5)

[1] Stay

[2] Dim

10.11.2 Activate sequence 1 - 5

Options:	Yes
	No

- Yes: Menu "Sequence 1 - 5" is activated.

10.11.3 Sequence 1 - 5 — Number of scenes in sequence 1 - 5

Options:	Scenes 2 - 16
----------	---------------

Between 2 to 16 scenes can be set per sequence via the parameter.

10.11.4 Sequence 1 - 5 — Activate channel 1 - 4

Options:	Yes
	No

The parameter is used to activate channel 1 - 4 in the selected sequence.

Deactivated channels can continue to be controlled via communication objects "ON/OFF/DIMMING". Active channels can only be set via the scenes in the sequences, Page 48.

10.11.5 Sequence 1 - 5 — Setting after stop of the sequence

Options:	Current colour
	Previously set colour
	All channels 0%
	All channels 100%
	All channels via 1 parameter
	Parameters per channel

The parameter is used to set the behaviour at stop of colour cycle.

- *Current colour*: The current colour value is retained.
- *Previously set colour*: The previously set colour is set before the sequence.
- *All channels 0%*: All active channels are set at 0% (Off).
- *All channels 100%*: All active channels are set at 100% (On).
- *All channels via 1 parameter*: All channels are set via one parameter ("Sequence stop brightness value all channels").
- *Parameters per channel*: Each channel is set via its own parameter ("Sequence stop brightness value channel 1 - 4").

10.11.6 Sequence 1 - 5 — Setting after sequence stop — Brightness value of all channels

Options: Setting option from 0 - 255

The parameter is used to set the setpoint on all channels after sequence stop.



NOTE

The parameter is only adjustable if the "Setting after sequence stop" parameter is set on "All channels via 1 parameter".

10.11.7 Sequence 1 - 5 — Setting after sequence stop — Brightness value of channel 1 - 4

Options: Setting option from 0 - 255

The parameter is used to set the setpoint on each individual channel after the sequence stops.



NOTE

The parameter is only adjustable if the "Setting after stop sequence" is set on "Parameters per channel".

10.11.8 Sequence 1 - 5 — Scene 0 - 15 — Channel 1 - 4

Options: Setting option from 0 - 255

The parameter is used to set the brightness values of the individual channels in the respective scenes.

Adjustment tool:





















Designation	Channel			Colour
	Red	Green	Blue	
Red	255	0	0	
Dark red	139	0	0	
Brick red	178	34	34	
Orchid	218	112	214	
Violet	238	130	238	
Green	0	255	0	
Dark green	0	100	0	
Spring green	0	255	127	
Green yellow	127	255	0	
Ocean green	32	178	170	
Blue	0	0	255	
Dark blue	0	0	139	
Royal blue	65	105	225	
Cyan	0	255	255	
Turquoise	64	224	208	
White	255	255	255	
Yellow	255	255	0	
Orange	255	165	0	
Bright pink	255	182	193	
Pink	255	20	147	

Table 13: Colour table for scenes

Additional colours and the associated RGB codes are available at:

www.uize.com/examples/sortable-color-table

10.11.9 Sequence 1 - 5 — Scene 0 - 15 — Time in the scene

Options: Setting option from 0 - 255 s

This parameter is used to set the time in the scene.

- 0: There is an immediate jump to the next scene or dimming takes place, see "Time for dimming to the next scene".

Adjustment tool:

Seconds	Minutes
30	½
60	1
120	2
180	3
240	4
255	4.25

Table 14: Time in the scene

10.11.10 Sequence 1 - 5 — Scene 0 - 15 — Time for dimming to the next scene

Options: Setting option from 0 - 255 s

This parameter is used to set the time in the scene.

- 0: There is an immediate jump to the next scene.

Adjustment tool:

Seconds	Minutes
30	½
60	1
120	2
180	3
240	4
255	4.25

Table 15: Dimming time to the next scene

10.12 Application "Flashing control parameter"

The behaviour during flashing can be set in application "Flashing control parameter". A time for the first and the second colour as well as the number of flashes can be set.

If parameter "Saving the current status after 5 minutes" has been activated, flashing remains active also after a voltage failure. Flashing can only be deactivated via the 'stop flashing' command.

10.12.1 Number of flashes

Options:	Setting option from 0 - 65535
----------	-------------------------------

The parameter is used to set the number of flashes.

- 0: Flashes up to the stop command.

10.12.2 Flashing ON-time (1st colour)

Options:	Setting option from 1 - 65535 10 ms
----------	-------------------------------------

The parameter is used to set the duration for the first colour.

10.12.3 Flashing OFF-time (2nd colour)

Options:	Setting option from 1 - 65535 10 ms
----------	-------------------------------------

The parameter is used to set the duration for the second colour.

10.12.4 1st colour channel 1 - 4

Options:	Setting option from 0 - 255
----------	-----------------------------

The parameter is used to set the 1st colour for flashing.

10.12.5 2nd colour with

Options:	Preferred colour Previous colour
----------	-------------------------------------

This parameter is used to set the selection of the second colour.

- *Preferred colour*: The colour set via parameter "2nd colour channel 1 - 4" is used.
- *Previous colour*: The last colour prior to flashing is used.

10.12.6 2nd colour channel 1 - 4

Options:	Setting option from 0 - 255
----------	-----------------------------

The parameter is used to set the 2nd colour for flashing.



NOTE

This parameter is only adjustable if parameter "2nd colour with" is set on "Preferred colour".

10.12.7 Setting after flashing

Options:	Current colour
	Previously set colour
	All channels 0%
	All channels 100%
	All channels via 1 parameter
	Parameters per channel

The parameter is used to set the behaviour at stop flashing.

- *Current colour*: The current colour value is retained.
- *Previously set colour*: The previously set colour is set before the sequence.
- *All channels 0%*: All channels are set at 0% (Off).
- *All channels 100%*: All channels are set at 100% (On).
- *All channels via 1 parameter*: All channels are set via one parameter ("Flashing stop brightness value all channels").
- *Parameters per channel*: Each channel is set via its own parameter ("Flashing stop brightness value channel 1 - 4").

10.12.8 Setting after flashing — Brightness value of all channels

Options:	Setting option from 0 - 255
----------	-----------------------------

The parameter is used to set the setpoint on all channels after flashing stops.



NOTE

The parameter is only adjustable if the "Setting after flashing" parameter is set on "All channels via 1 parameter".

10.12.9 Setting after flashing — Brightness value channel 1 - 4

Options:

Setting option from 0 - 255

The parameter is used to set the setpoint on each individual channel after flashing stops.



NOTE

The parameter is only adjustable if the "Setting after flashing" parameter is set on "Parameters per channel".

10.13 Communication objects

10.13.1 Switching — Switch ON/OFF (SOO)

Number	Name	Object function	Data type (DPT)
1	Channel 1 switch On/Off	Input	1.001 Switch
6	Channel 2 switch On/Off		
11	Channel 3 switch On/Off		
16	Channel 4 switch On/Off		
21	Master ON/OFF		

Channels 1 - 4 are switched via the object.

- *Channel 1 - 4 switch On/Off*: Channel is switched individually (1 = ON, 0 = OFF).
- *Master ON/OFF*: All channels are switched (1 = ON, 0 = OFF).

10.13.2 Dimming — Relative Setvalue Control (RSC)

Number	Name	Object function	Data type (DPT)
4	Channel 1 dimming relative	Input	3.007 Control_Dimming
9	Channel 2 dimming relative		
14	Channel 3 dimming relative		
19	Channel 4 dimming relative		
22	Master dimming relative		
26	Dimming Speed Control	Input	7.005 TimePeriodSec

Channel 1 - 4 is dimmed relative via the object.

- *Channel 1 - 4 dimming relative*: Channel is dimmed individually (UP/DOWN 0 - 100%).
- *Master dimming relative*: All channels are dimmed (UP/DOWN 0 - 100%).
- *Dimming Speed Control*: Setting the dimming time of 1 - 65535 s.

10.13.3 Dimming — Absolute Setvalue Control (ASC)

Number	Name	Object function	Data type (DPT)
3	Channel 1 dimming absolute	Input	5.001 Scaling
8	Channel 2 dimming absolute		
13	Channel 3 dimming absolute		
18	Channel 4 dimming absolute		
25	Dimming Speed Control	Input	7.005 TimePeriodSec

Channel 1 - 4 is dimmed absolute via the object.

- *Channel 1 - 4 dimming absolute*: Channel is dimmed individually (0 - 100%).
- *Dimming Speed Control*: Setting the dimming time of 1 - 65535 s.

10.13.4 Status — Info ON/OFF (IOO)

Number	Name	Object function	Data type (DPT)
2	Channel 1 info On/Off	Output	1.001 Switch
7	Channel 2 info On/Off		
12	Channel 3 info On/Off		
17	Channel 4 info On/Off		
23	LED Driver info ON/OFF		

The switching state of the actuator is signalled for channels 1 - 4 via the object.

- *Channel 1 - 4 info On/Off*: Message of binary status of the actuator (1 = ON, 0 = OFF).
- *LED Driver info ON/OFF*: Message of binary status of the LED driver (1 = ON, 0 = OFF).

10.13.5 Status — Actual Dimming Value (ADV)

Number	Name	Object function	Data type (DPT)
5	Channel 1 actual dimming value	Output	5.001 Scaling
10	Channel 2 actual dimming value		
15	Channel 3 actual dimming value		
20	Channel 4 actual dimming value		

The dimming status of the actuator is signalled for channels 1 - 4 via the object.

- *Channel 1 ... 4 actual dimming value*: Setting option of 0 - 100%.

10.13.6 Status — Output Overload Detection (OVL)

Number	Name	Object function	Data type (DPT)
27	Overload Detection	Output	1.005 Alarm

An overload of the device can be signalled to the KNX bus via the object.

- 1 = Alarm
- 0 = no Alarm

10.13.7 Status — Output Over Temperature Detection

Number	Name	Object function	Data type (DPT)
28	Over Temperature Detection	Output	1.005 Alarm

An over temperature of the device can be signalled to the KNX bus via the object.

- 1 = Alarm
- 0 = no Alarm

10.13.8 Setpoint control — Value RGB

Number	Name	Object function	Data type (DPT)
24	RGB dimming absolute	Input	232.600 Colour_RGB

The object is used to set the absolute brightness values of the RGB channels.

- 1st byte, channel 1 (R): setting option of 0 - 255.
- 2nd byte, channel 2 (G): setting option of 0 - 255.
- 3rd byte, channel 3 (B): setting option of 0 - 255.

10.13.9 Scene control — Input Scene Number (SN)

Number	Name	Object function	Data type (DPT)
29	Scene Number	Input	17.001 SceneNumber

The object is used to set the number of scenes.

- Setting option from 0 - 63.

10.13.10 Scene control — Input Scene Control (SC)

Number	Name	Object function	Data type (DPT)
29	Scene Control	Input	18.001 SceneControl

The object is used to activate, program and number scenes.

- Scene number setting option from 0 - 63.

10.13.11 Colour cycle control — Start/Stop Color Cycle

Number	Name	Object function	Data type (DPT)
31	Color Cycle Control	Input	1.010 Start

The object is used to start and stop the colour cycle.

- 1 = start
- 0 = stop

10.13.12 Colour cycle control — Color cycle speed control

Number	Name	Object function	Data type (DPT)
32	Color Cycle Length	Input	7.005 TimePeriodSec

The object is used to set the length of the colour cycle in seconds.

- RGBW/RGB+W: Setting option from 20 - 65535 s
- RGB: Setting option from 15 - 65535 s
- WE (White Emotion): Setting option from 10 - 65535 s

10.13.13 Sequence control — Start/Stop sequence

Number	Name	Object function	Data type (DPT)
33	Sequence 1 Control	Input	1.010 Start
34	Sequence 2 Control		
35	Sequence 3 Control		
36	Sequence 4 Control		
37	Sequence 5 Control		

The object is used to start or stop the sequence.

- 1 = start
- 0 = stop

10.13.14 Flashing control — Start/Stop flashing

Number	Name	Object function	Data type (DPT)
31	Flashing control	Input	1.010 Start

The object is used to start or stop flashing.

- 1 = start
- 0 = stop

11 Notes

12 Index

A	
Absolute dimming speed by	35
Activate	
channels	23
colour cycle	39
flashing control	39
scene control	39
scenes	39
sequences	39
Application	
"Bus voltage failure/return parameters"	36
"Colour cycle control"	42
"Dimming parameters"	34
"Flashing control"	50
"Global parameters"	23
"Scene control"	40
"Sequence parameters"	45
"Special functions"	39
"Status parameters"	24
"Switching parameters"	26
Application program	19
Assigning a physical address	15
Assigning the group address(es)	15
B	
Brightness value	
after the ON command	26
minimal change	25
Bus voltage failure	
selection of value	38
value all channels	38
value channel 1 - 4	38
Bus voltage failure/return parameters	20
Bus voltage return	
message delay	36
selection of value	37
value channel 1 - 4	37
value of all channels	37
C	
Channel allocation	23
Cleaning	18
Colour cycle	
active function	43
dimming speed via	42
setting after stop	44
Colour cycle parameters	21
Colour cycle stop	
brightness value of all channels	44
Commissioning	15
Communication object	
absolute Setvalue Control	53
Actual Dimming Value	54
Color Cycle Speed Control	55
info ON/OFF	54
input Scene Number	55
Output Over Temperature Detection	54
Output Overload Detection	54
Relative Setvalue Control	53
Start/Stop Color Cycle	55
Start/Stop flashing	56
Start/Stop sequence	56
switch ON/OFF	53
value RGB	55
Communication objects	53
Connection and mounting	14
Control elements	16
D	
Description of application	19
Description of objects	19
Description of parameters	19
Device overview	11
Differentiating the application program	15
Dimensional drawings	13
Dimming curve	24
Dimming mode selection	34
Dimming parameters	20
Dimming procedure	24
Dimming speed	
at OFF command	31
at ON command	29
relative	36
relative by	36
Dimming value	
maximum	23
minimum	23
E	
Electrical connection	14
F	
Features of equipment	10
Features of functions	10
Feedback signal	
brightness value	25
error	25
switching state	24
Flashes	
number of flashes	50
Flashing	
1st colour	50
2nd colour	50, 51
flashing OFF-time	50
flashing ON-time	50
setting after flashing	51
Flashing parameters	22
Flashing stop	
brightness value of all channels	51
G	
Global parameters	19

I		
Improper use	7	
Information and symbols used	6	
Information on protection of the environment	9	
Installation site	14	
Intended use	7	
L		
Length of the colour cycle		
RGB	43	
RGBW and (RGB+W)	43	
White Emotion	43	
M		
Maintenance	18	
Maintenance-free device	18	
N		
Notes	57	
Notes on the instruction manual	5	
O		
Operating statuses	17	
Operation	16	
P		
Passage of time for a sequence	45	
Q		
Qualification of personnel	8	
R		
Relative OFF	36	
S		
Safety	6	
Safety instructions	8	
Scene		
activate channel	41	
channel 1 - 4	48	
dimming time	49	
select	41	
set channel	41	
time in the scene	49	
Scene control of all parameters	41	
Scene parameters	21	
Selecting the application program	15	
Sequence		
activate	46	
activate channel	46	
number of scenes	46	
setting after stop	46	
Sequence stop		
brightness value of all channels	47, 52	
Setup and function	10	
Software	15	
Special functions	20	
Status parameters	19	
Switching parameters	20	
Switch-off delay	28	
Switch-on		
via dimming	29	
via jump	29	
Switch-on delay	27	
T		
Target group	8	
Technical data	12	
V		
Voltage failure		
save status	25	

A member of the ABB Group

Busch-Jaeger Elektro GmbH

PO box
58505 Lüdenscheid

Freisenbergstraße 2
58513 Lüdenscheid

www.BUSCH-JAEGER.com
info.bje@de.abb.com

Central sales service:

Tel.: +49 2351 956-1600
Fax: +49 2351 956-1700

Notice

We reserve the right to make technical changes at all times as well as changes to the contents of this document without prior notice. The detailed specifications agreed upon apply for orders. ABB accepts no responsibility for possible errors or incompleteness in this document.

We reserve all rights to this document and the topics and illustrations contained therein. The document and its contents, or extracts thereof, must not be reproduced, transmitted or reused by third parties without prior written consent by ABB

Copyright© 2016 Busch-Jaeger
Elektro GmbH
All rights reserved