

Operating Instructions

CO₂-sensor
1091 U



1	Notes on the instruction manual	4
2	Safety.....	5
	2.1 Information and symbols used.....	5
	2.2 Intended use.....	6
	2.3 Improper use	6
	2.4 Target group / Qualifications of personnel.....	7
	2.4.1 Operation	7
	2.4.2 Installation, commissioning and maintenance	7
	2.5 Safety instructions	8
3	Information on protection of the environment	9
	3.1 Environment	9
4	Setup and function	10
	4.1 Functions.....	10
	4.2 Sources of interference	10
	4.3 Possible combinations.....	11
5	Technical data.....	12
	5.1 Technical data	12
	5.2 Factory settings	13
6	Connection, installation / mounting.....	14
	6.1 Requirements for the electrician.....	14
	6.2 Mounting.....	15
	6.3 Electrical connection.....	17
7	Commissioning	18
8	Operation	20
	8.1 Operating modes.....	20
	8.2 Normal operation.....	21
	8.2.1 Display	21
	8.2.2 Messages.....	21
	8.2.3 Button lock	24
	8.3 Extended operation	26
	8.3.1 Change into extended operation.....	26
	8.3.2 Display	26
	8.3.3 Button assignment	26
	8.3.4 Menu "Threshold values / switch-off delay" for the ventilation control.....	27
	8.3.5 Menu "Fan control / window control"	29
	8.3.6 Menu "Display lighting"	30
	8.3.7 Menu "Temperature correcting value"	31
	8.3.8 Menu "CO ₂ correcting value"	32
	8.3.9 Menu "Load current"	33
	8.3.10 Menu "Manual operation".....	34
	8.3.11 RESET (resetting the device)	35
	8.4 Operation manual mode.....	36

9	Maintenance	37
9.1	Cleaning	37
10	Information about planning and application	38
10.1	Menu tree	38
11	Index	39

1 Notes on the instruction manual

Please read through this manual carefully and observe the information it contains. This will assist you in preventing injuries and damage to property, and ensure both reliable operation and a long service life for the device.

Please keep this manual in a safe place.

If you pass the device on, also pass on this manual along with it.

Busch-Jaeger accepts no liability for any failure to observe the instructions in this manual.

If you require additional information or have questions about the device, please contact Busch-Jaeger or visit our Internet site at:

www.BUSCH-JAEGER.de

2 Safety

The device has been constructed according to the latest valid regulations governing technology and is operationally reliable. It has been tested and left the factory in a technically safe and reliable state.

However, residual hazards remain. Read and adhere to the safety instructions to prevent hazards of this kind.

Busch-Jaeger accepts no liability for any failure to observe the safety instructions.

2.1 Information and symbols used

The following Instructions point to particular hazards involved in the use of the device or provide practical instructions:



Danger

Risk of death / serious damage to health

- The respective warning symbol in connection with the signal word "Danger" indicates an imminently threatening danger which leads to death or serious (irreversible) injuries.



Warning

Serious damage to health

- The respective warning symbol in connection with the signal word "Warning" indicates a threatening danger which can lead to death or serious (irreversible) injuries.



Caution

Damage to health

- The respective warning symbol in connection with the signal word "Caution" indicates a danger which can lead to minor (reversible) injuries.



Attention

Damage to property

- This symbol in connection with the signal word "Attention" indicates a situation which could cause damage to the product itself or to objects in its surroundings.



NOTE

This symbol in connection with the word "Note" indicates useful tips and recommendations for the efficient handling of the product.



This symbol alerts to electric voltage.

2.2 Intended use

This device is a CO₂ monitoring device for flush-mounted installation.

During an increase in the CO₂ level or concentration of relative humidity, the control of the device can be used to control the ventilation with a fan or a window.

The device is intended for the following:

- Operation according to the listed technical data,
- Installation in dry interior rooms and suitable flush-mounted boxes,
- Use with the connecting options available on the device.

The intended use also includes adherence to all specifications in this manual.

2.3 Improper use

Each use not listed in Chapter 2.2 “Intended use“ on page 6 is deemed improper use and can lead to personal injury and damage to property.

Busch-Jaeger is not liable for damages caused by use deemed contrary to the intended use of the device. The associated risk is borne exclusively by the user/operator.

The device is not intended for the following:

- Unauthorized structural changes
- Repairs
- Outdoor use
- The use in bathroom areas
- The control of the device serves for monitoring and regulating the quality of the air. It must not be used for safety-related tasks.

2.4 Target group / Qualifications of personnel

2.4.1 Operation

No special qualifications are needed to operate the device.

2.4.2 Installation, commissioning and maintenance

Installation, commissioning and maintenance of the device must only be carried out by trained and properly qualified electrical installers.

The electrical installer must have read and understood the manual and follow the instructions provided.

The electrical installer must adhere to the valid national regulations in his/her country governing the installation, functional test, repair and maintenance of electrical products.

The electrical installer must be familiar with and correctly apply the "five safety rules" (DIN VDE 0105, EN 50110):

1. Disconnect
2. Secure against being re-connected
3. Ensure there is no voltage
4. Connect to earth and short-circuit
5. Cover or barricade adjacent live parts

2.5 Safety instructions



Danger - Electric voltage!

Electric voltage! Risk of death and fire due to electric voltage of 230 V.

Dangerous currents flow through the body when coming into direct or indirect contact with live components. This can result in electric shock, burns or even death.

- Work on the 230 V supply system may only be performed by authorised and qualified electricians.
- Disconnect the mains power supply before installation / disassembly.
- Never use the device with damaged connecting cables.
- Do not open covers firmly bolted to the housing of the device.
- Use the device only in a technically faultless state.
- Do not make changes to or perform repairs on the device, on its components or its accessories.
- Keep the device away from water and wet surroundings.



Caution! - Risk of damaging the device due to external factors!

Moisture and contamination can damage the device.

- Protect the device against humidity, dirt and damage during transport, storage and operation.

3 Information on protection of the environment

3.1 Environment



Consider the protection of the environment!

Used electric and electronic devices must not be disposed of with domestic waste.

- The device contains valuable raw materials which can be recycled. Therefore, dispose of the device at the appropriate collecting depot.

All packaging materials and devices bear the markings and test seals for proper disposal. Always dispose of the packaging material and electric devices and their components via the authorized collecting depots and disposal companies.

The products meet the legal requirements, in particular the laws governing electronic and electrical devices and the REACH ordinance.

(EU Directive 2012/19/EU WEEE and 2011/65/EU RoHS)

(EU REACH ordinance and law for the implementation of the ordinance (EC) No.1907/2006).

4 Setup and function

4.1 Functions

The device is a functional measuring device and is installed flush-mounted in the wall. Next to monitoring of the air quality it also offers the option of controlling a room ventilation via a fan or a window.

The device measures the following values:

- CO₂ content of the air
- Relative humidity of the room
- Temperature
- Air pressure (absolute)

4.2 Sources of interference

The measured results of the device can be influenced negatively by external sources. The following contains possible sources of interference:

- Draught and movement of air.
 - E.g. from windows, doors, convection, heating or persons.
- Heating up or cooling down.
 - E.g. solar irradiation or mounting on an outside wall.
- Heat sources
 - In the direct vicinity of installed electric loads, e.g. dimmers
- Shocks or impacts the device was or is being subjected to.
- Contamination from paint, wallpaper adhesive, dust, etc.
 - E.g. during renovation work
- Organic solutions or their vapours.
 - E.g. cleaning agents.
- Softening agents from stick-on labels and packaging.
 - E.g. air-cushion foil or polystyrene

Constant deviations of the measured values can be corrected in the control, see chapter 8.3.8 "Menu "CO₂ correcting value"" on page 32 and see chapter 8.3.7 "Menu "Temperature correcting value"" on page 31. Constant deviations of the measured values are caused by permanently existing sources of interference.

4.3 Possible combinations



	 <p>1091 U</p>
 <p>6435-xxx</p>	<p>X</p>

Table 1: Possible combinations

5 Technical data

5.1 Technical data

Designation	Value
Nominal voltage:	230 V AC, $\pm 10\%$, 50 Hz
Temperature range:	0°C - +35°C
Storage temperature:	-10°C - +60°C
Protection type:	IP 20
Display size:	3.8 cm (1.5")
Dimensions of power adapter:	44 x 44 x 32 mm (for BS flush-mounted box without claws)
Outputs:	2 floating relays with a common connection for the switching voltage
Switching capacity: (each for both relays)	6 A / 230 V AC $\cos \phi$ 1
Setting values	
▪ Carbon dioxide (10 ppm dissolution):	800 ppm ... 1500 ppm
▪ Relative humidity (1% dissolution)	40 % ... 95 %
Display values	
▪ Carbon dioxide:	500 ppm ... 2000 ppm
▪ Relative humidity:	20 % ... 99 %
▪ Temperature:	0 °C ... 35 °C
▪ Air pressure:	300 hPa ... 1100 hPa
Mode of operation (DIN EN 60730-1)	1C
Degree of contamination (DIN EN 60730-1)	2
Rated surge voltage (DIN EN 60730-1)	4000 V

Table 2: Technical data

5.2 Factory settings

Factory settings	Value
CO ₂ threshold value	800 ppm
rF (RH = relative humidity) threshold value	60 %
Switch-off delay	3 minutes
Control	Fan
Display illumination	Automatic mode
Temperature offset (temperature correcting value)	0°C
CO ₂ offset (CO ₂ correcting value)	0 ppm
Load current	1 ampere
Manual operation	ON

Table 3: Factory settings

6 Connection, installation / mounting



Danger - Electric voltage!

Risk of death due to electrical voltage of 230 V during short-circuit in the low-voltage conduit.

- Low-voltage and 230 V conduits must not be installed together in a flush-mounted box!

6.1 Requirements for the electrician



Danger - Electric voltage!

Install the device only if you have the necessary electrical engineering knowledge and experience.

- Incorrect installation endangers your life and that of the user of the electrical system.
- Incorrect installation can cause serious damage to property, e.g. due to fire.

The minimum necessary expert knowledge and requirements for the installation are as follows:

- Apply the "five safety rules" (DIN VDE 0105, EN 50110):
 1. Disconnect
 2. Secure against being re-connected
 3. Ensure there is no voltage
 4. Connect to earth and short-circuit
 5. Cover or barricade adjacent live parts.
- Use suitable personal protective clothing.
- Use only suitable tools and measuring devices.
- Check the type of supply network (TN system, IT system, TT system) to secure the following power supply conditions (classic connection to ground, protective earthing, necessary additional measures, etc.).

6.2 Mounting



Caution! The device can sustain damage when coming into contact with hard objects!

The plastic parts of the device are sensitive.

- Pull the attachment off only with your hands.
- Do not lever parts off with screwdrivers or similar hard objects.

The flush-mounted insert must only be installed in flush-mounted wall boxes according to DIN 49073-1, Part 1, or suitable surface-mounted housings.

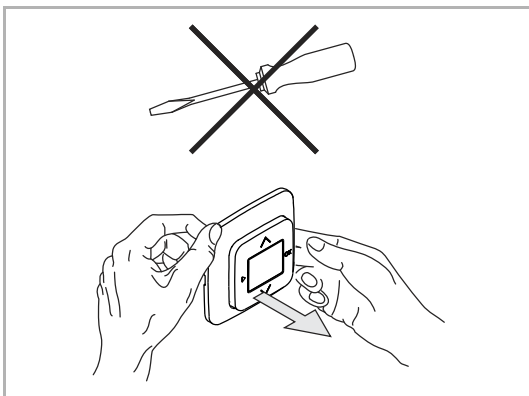

Fig. 1: Wall mounting: pulling off the attachment

- If the device is already mounted or assembled, pull off the attachment from the flush-mounted insert with the aid of the cover frame.

To install the device, perform the following steps:

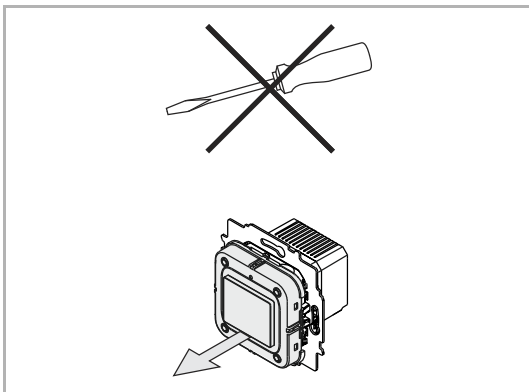

Fig. 2: State of the device at the point of delivery: pulling off the attachment

- If the state of the device is at the point of delivery, pull off the attachment from the flush-mounted insert with your hands.
- Pull the attachment off only with your hands!
- Do not lever parts off with screwdrivers or similar hard objects. This damages the device.
- When pulling off, first the resistance of the spring clamps must be overcome.

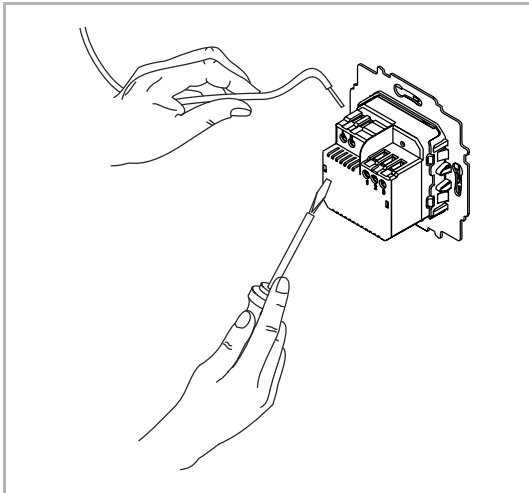

Fig. 3: Connecting the cables

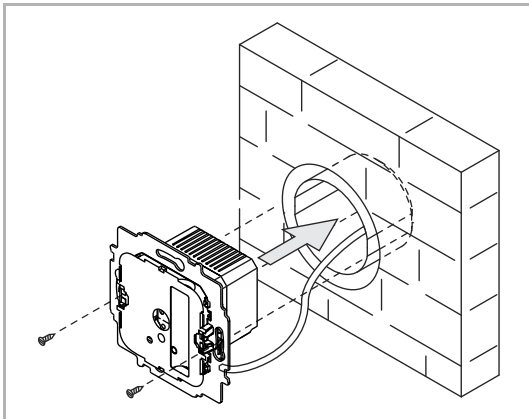

Fig. 4: Mounting the flush-mounted insert

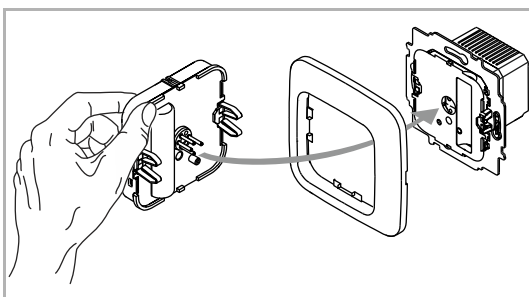

Fig. 5: Mounting the display

1. Connect the cables to the flush-mounted insert.
 - For the connection assignment, see chapter 6.3 “Electrical connection” on page 17.
2. Mount the flush-mounted insert.
3. Plug the attachment together with the cover frame onto the flush-mounted insert.
 - Ensure that the plug-in connection on the rear side does not get jammed.
 - If mounting is difficult, check whether a burr has formed at the lock-in opening of the flush-mounted insert and remove it.

The device is now mounted.

6.3 Electrical connection

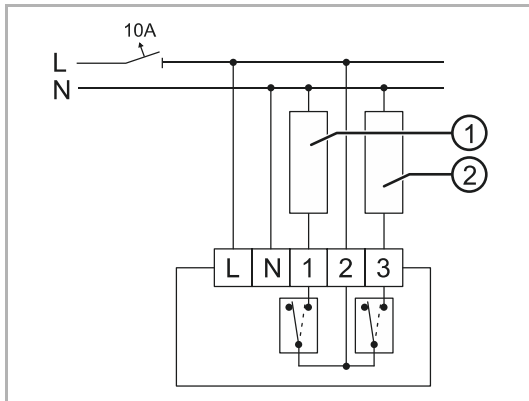

Fig. 6: Control for 230 V

Window control:

- [1] Open
- [2] Close

Fan control:

- [1] Level 1
- [2] Level 2

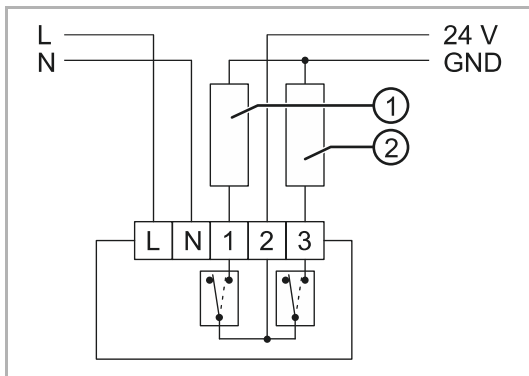

Fig. 7: Control for 24 V

Window control:

- [1] Open
- [2] Close

Fan control:

- [1] Level 1
- [2] Level 2



NOTE

- The relays are locked against each other on the software side. The reverse time amounts to at least 500 ms.
- If values that lie below the threshold value are measured after a mains failure, the control switches the window to closed. This ensures that the window is closed.

7 Commissioning

The setup is carried out automatically during initial commissioning or when resetting the settings (RESET).

All settings, except for the language, can be made in the settings menu at a later point in time. If certain functions are not relevant for you, confirm the preset values with the "OK" button to switch to the next menu item.

After initial commissioning has been carried out, the device automatically performs a calibration.

Carry out the device settings in the following order.

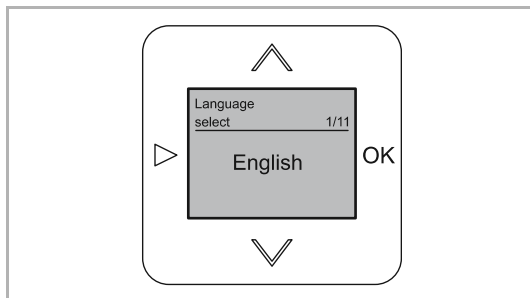

Fig. 8: Setup menu "Language"

Language

The language is set once during initial commissioning or after a reset. A change is no longer possible during standard operation. During a later reset all entered data are deleted and must then be entered anew.

During initial commissioning or after a reset the device automatically switches to menu "Language".

1. Use the "UP / DOWN" buttons to select a language.
2. Confirm the selection with the "OK" button.
 - The device automatically switches to the next menu.

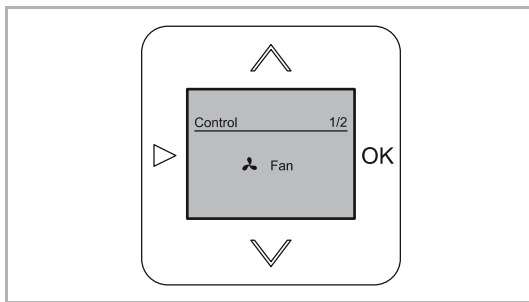

Fig. 9: Setup menu "Control"

Control, see chapter 8.3.5 "Menu "Fan control / window control"" on page 29

- Select between fan control and window control.

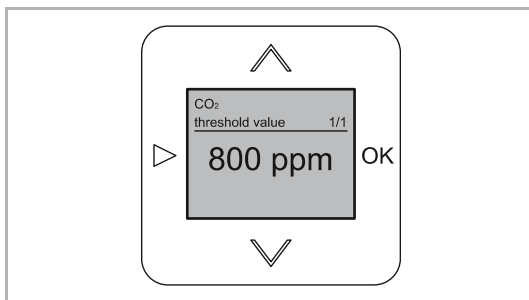

Fig. 10: Setup menu "CO₂ threshold value"

CO₂ threshold value, see chapter 8.3.4 "Menu "Threshold values / switch-off delay" for the ventilation control " on page 27

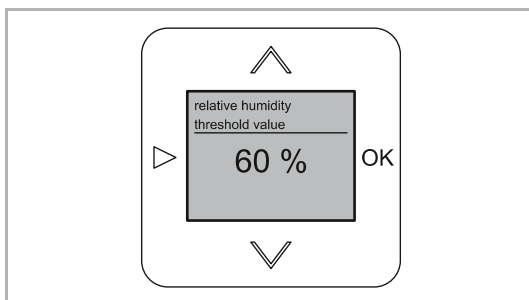

Fig. 11: Setup menu "Threshold value of relative humidity"

Threshold value of relative humidity, see chapter 8.3.4 "Menu "Threshold values / switch-off delay" for the ventilation control " on page 27



Fig. 12: Setup menu "Switch-off delay"

Switch-off delay, see chapter 8.3.4 "Menu "Threshold values / switch-off delay" for the ventilation control " on page 27

8 Operation

8.1 Operating modes

The device has three operating modes.

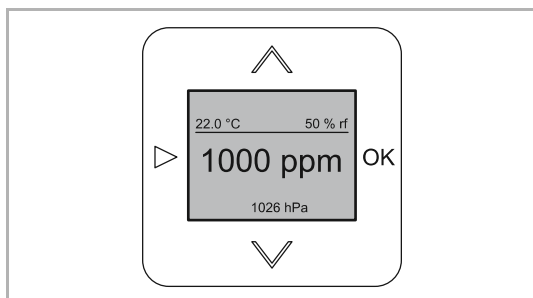

Fig. 13: Standard operation

Standard operation, see chapter 8.2 “Normal operation“ on page 21

- All functions run automatically. Manual operation is not required.

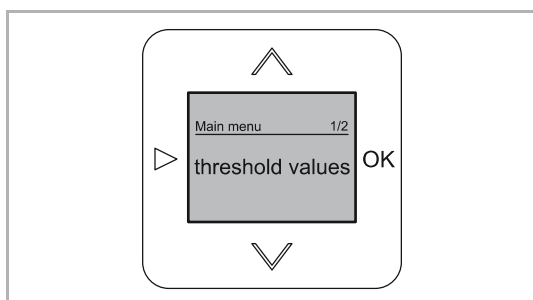

Fig. 14: Settings / setup

Settings, see chapter 8.3 “Extended operation“ on page 26

- E.g. setting the threshold value.

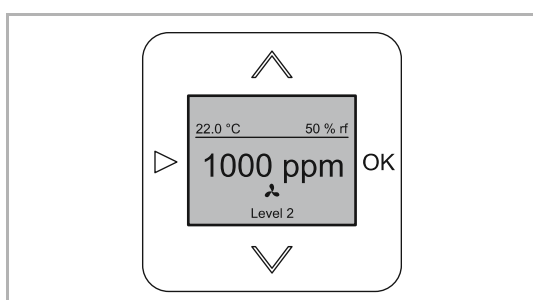

Fig. 15: Manual mode

Manual mode, see chapter 8.4 “Operation manual mode“ on page 36

- E.g. switching the ventilation manually.

8.2 Normal operation

8.2.1 Display

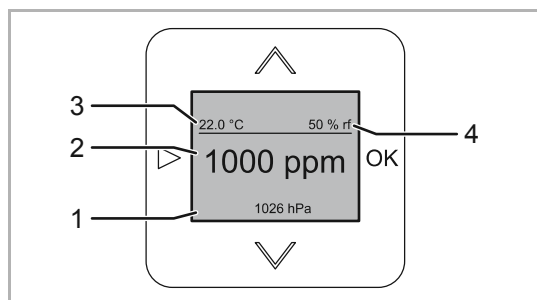

Fig. 15: Display overview

- [1] Air pressure in hPa
- [2] CO₂ value in ppm
- [3] Room temperature in °C
- [4] Relative humidity in rF (RH)

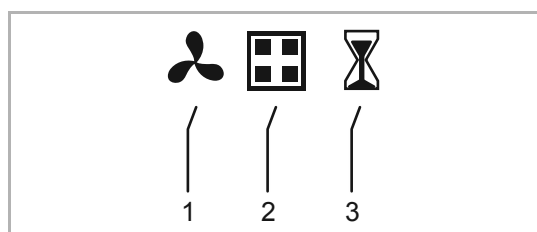

Fig. 16: Overview of display icons

- [1] Fan control
- [2] Window control
- [3] Calibration

8.2.2 Messages

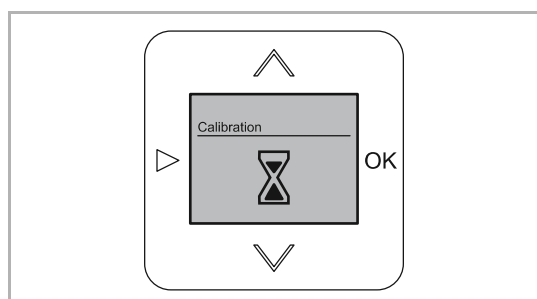

Fig. 17: Waiting on the calibration

After a reset or a mains failure the device re-calibrates itself automatically. When the first reliable measured values are available, the device switches to the standard display.



NOTE

- After strong temperature fluctuations it can take a long time until the device acclimatises and has constant values. This could be the case after a new installation, for example. A half hour calibration time is not unusual in this case.
- The flashing of the values for "°C" and "RH" stops when the self-heating process of the device has concluded.
- When the threshold values are exceeded, the display is illuminated red.
 - When the threshold values drop below their set value, the display is illuminated again in white.
- If the status of the relay is altered by hand, it is retained for the duration of the switch-off delay. Then the status of the relay switches back into the correct status (after the measured values and threshold values).

For a set window control:

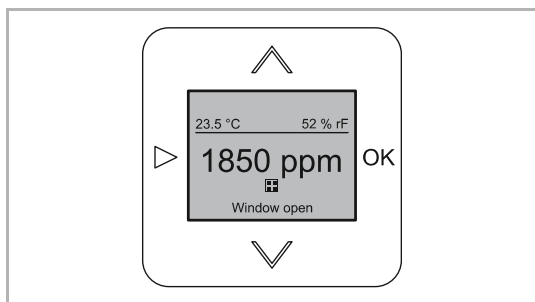

Fig. 18: Window control: CO₂ threshold value exceeded

- The entered CO₂ limit value has been exceeded.
- The window opens automatically.

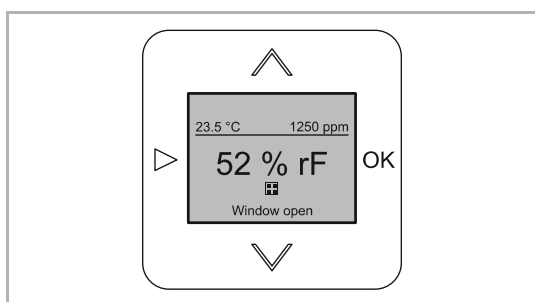

Fig. 19: Window control: RH threshold value exceeded

- The entered limit value for the relative humidity (RH) has been exceeded.
- The window opens automatically.

Exceeding of the threshold value:

- If the set threshold value is exceeded, the control switches the window to open. The open circuit is maintained for 3 minutes.

Dropping below the threshold value:

- If the measured value drops below the threshold value by 10 ppm or 1% for the relative humidity (RH), the control switches the window to close after the set switch-off delay. The close circuit is maintained for 3 minutes.

For a set fan control:

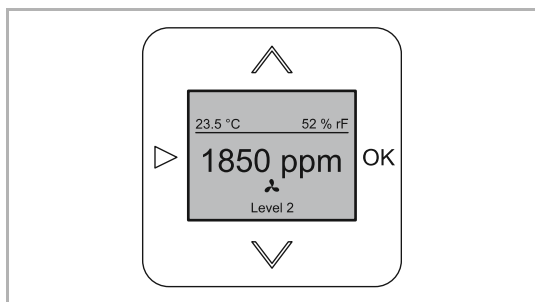

Fig. 20: Fan control: CO₂ threshold value exceeded

- The entered CO₂ limit value has been exceeded.
- The fan switches on automatically.

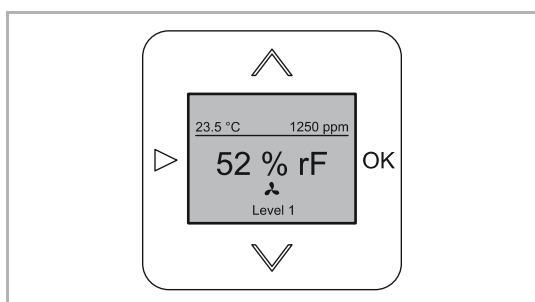

Fig. 21: Fan control: RH threshold value exceeded

- The entered limit value for the relative humidity (RH) has been exceeded.
- The fan switches on automatically.

Exceeding of the threshold value:

- If the set threshold value is exceeded, the control switches the fan to level 1.
- If the measured value rises by a further 10%, the control switches the fan to level 2.

Dropping below the threshold value:

- If the measured value drops below the threshold value by 10 ppm or 1% for the relative humidity (RH), the control switches the fan off again after the set switch-off delay.
- Level 2 is switched off immediately when dropping below the threshold value.



NOTE

- If the 2nd level switched on, the contact of the 1st level is switched off.
- The CO₂ value has priority in the display.
 - If the CO₂ value is the first to drop below the threshold value, the display changes to the RH value in the centre.
 - The relay remains active until both values are again below the threshold value.

8.2.3 Button lock

To prevent unintentional operation, a button lock can be set up.

- The activated button lock is not shown on the display.
- The display illumination is independent of the button lock.

The button lock is switched on and off in the same manner.

To prevent the button lock from being triggered unintentionally, the cover plate (operating plate) of the control element must be removed for the setup.

Use the following steps to switch the button lock on or off:

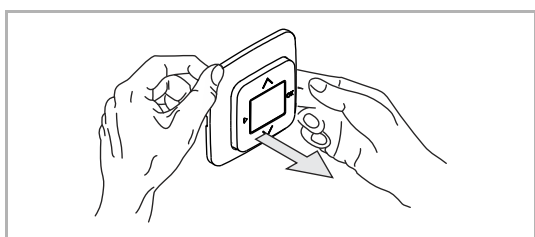

Fig. 22: Pulling the control element off

1. Pull the control element of the device from the flush-mounted insert with the aid of the cover frame.

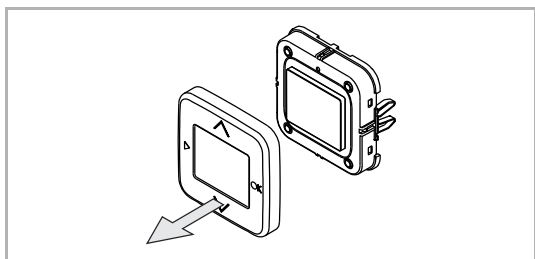

Fig. 23: Removing the cover plate (operating plate)

2. Pull the cover plate from the control element.

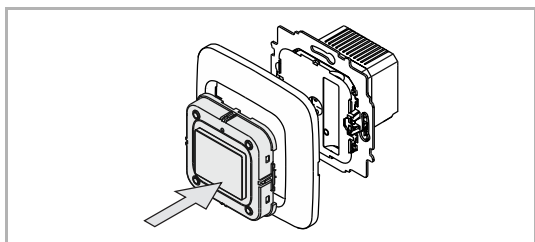

Fig. 24: Plugging the control element on

3. Plug the control element back on.
 - Ensure that the control element is plugged on the right way around. Otherwise the plug contacts could sustain damage.
 - The interruption of power causes the device to carry out a calibration after the plug-on.

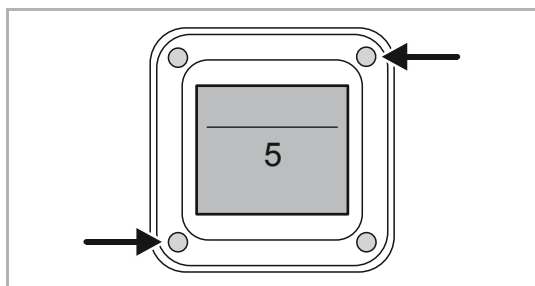

Fig. 25: Switching the button lock on

- 4 Press the buttons at the bottom left and top right simultaneously for at least 5 seconds.
 - This requires a small object. E.g. a ballpoint pen. The buttons cannot be pressed in far enough with the fingers.
 - Do not use sharp, pointed objects which could damage the device.
 - Once both buttons have been pressed in far enough, the display changes to the "Button lock" function. The time is counted down on the display. The buttons must continue to be pressed in further during the countdown.
 - After the time has expired, the button lock is switched on / off. No further message is displayed.

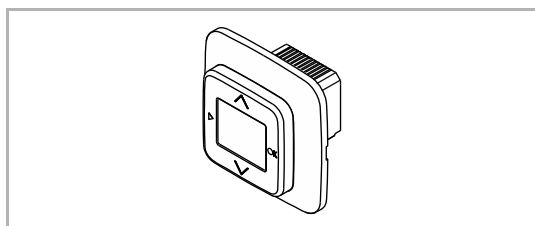

Fig. 26: Mounting the cover disc / cover plate

5. Attach the cover disc and the cover plate back on the device.

8.3 Extended operation

8.3.1 Change into extended operation

Use the following steps to change into extended operation:

1. Press the "CHANGE" button for at least 5 seconds.
 - The device changes into extended operation.

8.3.2 Display

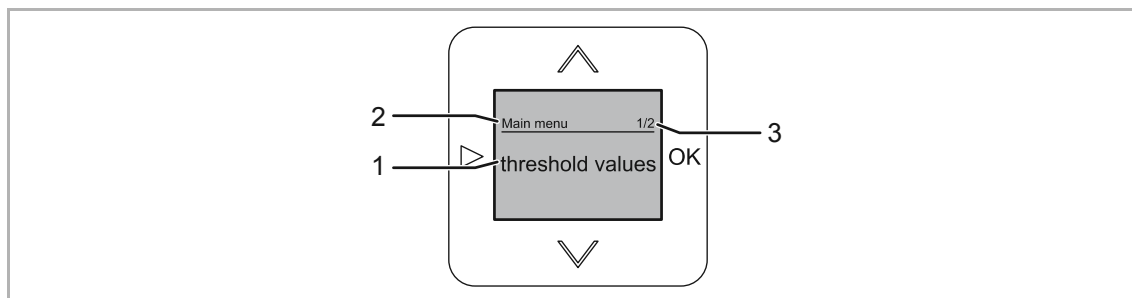

Fig. 27: Display overview of extended operation

- [1] Selected menu item
- [2] Menu / menu level
- [3] Menu number

8.3.3 Button assignment

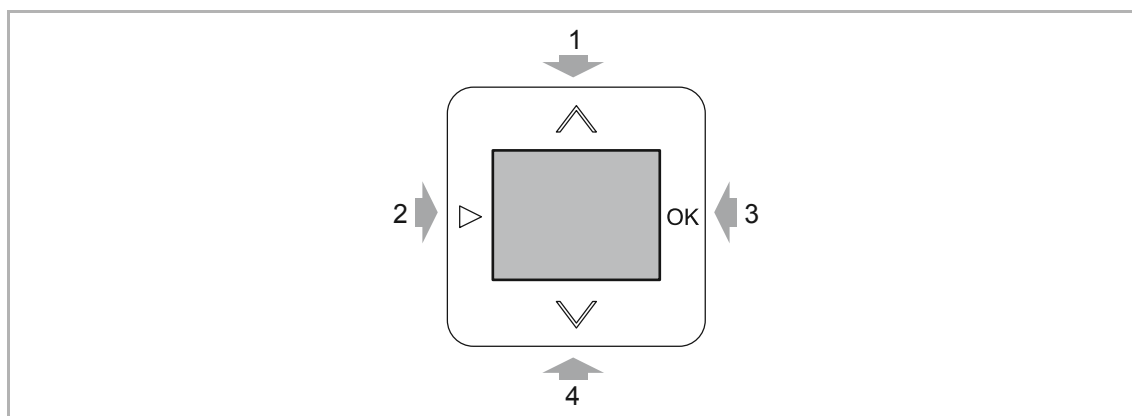

Fig. 28: Button assignment for setting mode

- [1] Button "UP":
Preceding menu item
- [2] Button "CHANGE":
One level higher
Change to extended operation (press the button for at least 5 seconds)
- [3] Button "OK":
Open menu
Confirm selection
- [4] Button "DOWN":
Next menu item

8.3.4 Menu "Threshold values / switch-off delay" for the ventilation control

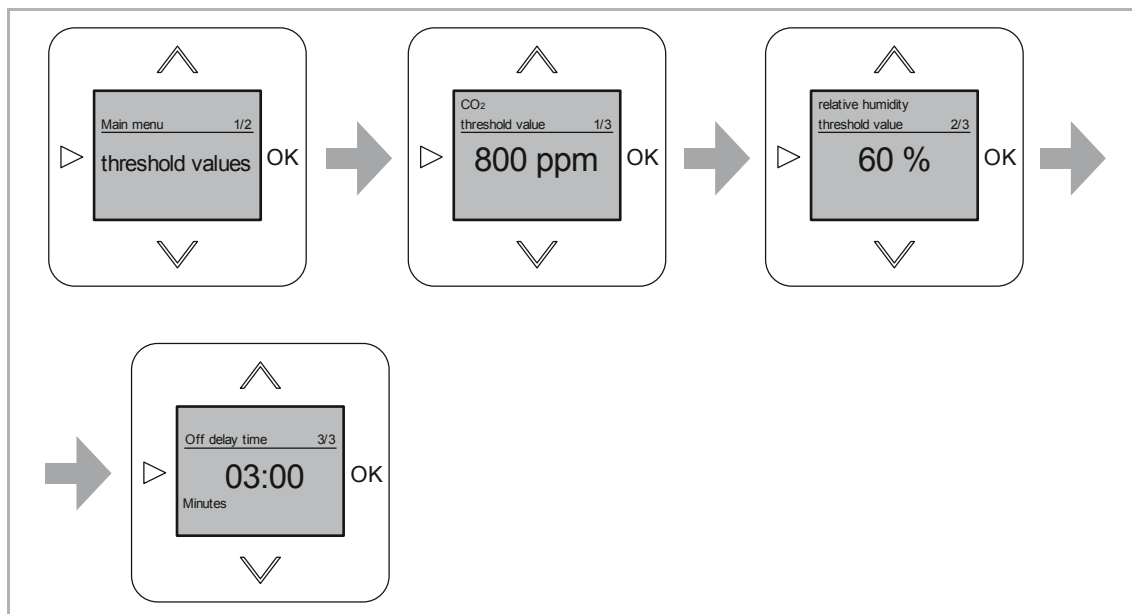

Fig. 29: Entering threshold values / switch-off delay

The ventilation is controlled via threshold values. An action is triggered when one of these threshold values is exceeded or drops below the set value. E.g. a window is opened when the entered CO₂ threshold value is exceeded.

Threshold values / switch-off delay	Information
CO ₂	<p>CO₂ (carbon dioxide) is naturally present in the air. Conclusions can be drawn about the quality of the air on the basis of its concentration within closed rooms.</p> <ul style="list-style-type: none"> ▪ The CO₂ threshold value can be set on the device between 800 ppm and 1500 ppm in steps of 10 ppm. ▪ The display is illuminated in red as long as the CO₂ threshold value is exceeded. ▪ After initial commissioning it can a certain amount of time until the CO₂ value is measured with its final accuracy.
Relative humidity	<p>The relative humidity describes the amount of moisture in the air in dependence of the air temperature.</p> <ul style="list-style-type: none"> ▪ The optimum value of the relative humidity depends on the local conditions. ▪ The RH threshold value can be set on the device between 40% and 80% in steps of 1%. ▪ The display is illuminated in red as long as the RH threshold value is exceeded.

Switch-off delay	<p>This is the period the fan keeps on running after the threshold value has dropped below its set value.</p> <p>With entry of a switch-off delay the threshold values clearly drop below their set value and it takes longer until they are exceeded again. This prevents the fan from being constantly switched on and off at short intervals.</p> <ul style="list-style-type: none">▪ The switch-off delay can be set on the device between 0:30 minutes and 30 minutes in steps of 10 seconds.▪ The switch-off delay starts when the set value drops by 10 ppm, or 1% for RH.▪ During the switch-off delay the display is no longer illuminated in red.
------------------	---

Table 4: Threshold values / switch-off delay

Input of threshold values and switch-off delay

1. Select menu "Threshold values".
 - The display shows the preset "CO₂" threshold value.
2. Set the desired threshold value with buttons "UP / DOWN".
 - This setting is configured in steps of 10 ppm.
3. Confirm your setting with the "OK" button.
 - The menu automatically switches to the next setting option "Relative humidity".
 - The display shows the preset "rF" (RH) threshold value.
4. Set the desired threshold value with buttons "UP / DOWN".
 - This setting is configured in steps of 1%.
5. Confirm your setting with the "OK" button.
 - The menu automatically switches to the next setting option "Switch-off delay".
 - The display shows the preset value.
6. Set the desired value with buttons "UP / DOWN".
 - This setting is configured in steps of 10 seconds.
7. Confirm your setting with the "OK" button.

8.3.5 Menu "Fan control / window control"

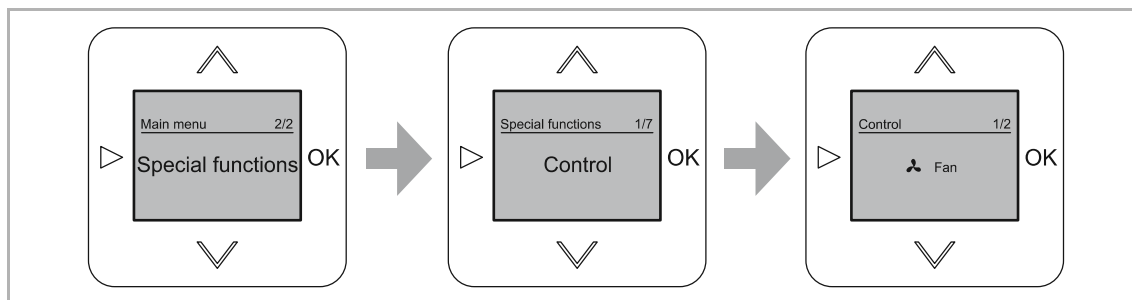

Fig. 30: Switchover of fan control / window control

Aside from the display of air-quality values, the device also gives you the option of a ventilation control via a fan or via opening / closing of windows.

Select from the following setting options:

Menu function	Description
Fan	The ventilation is controlled using fans.
Window	The ventilation is controlled using windows.

Tab.5: Fan control / window control

Activation / switchover of the control for a fan or window.

1. Select menu "Special functions".
2. Select menu "Control".
3. Select the desired control option.
4. Confirm your selection with the "OK" button.

8.3.6 Menu "Display lighting"

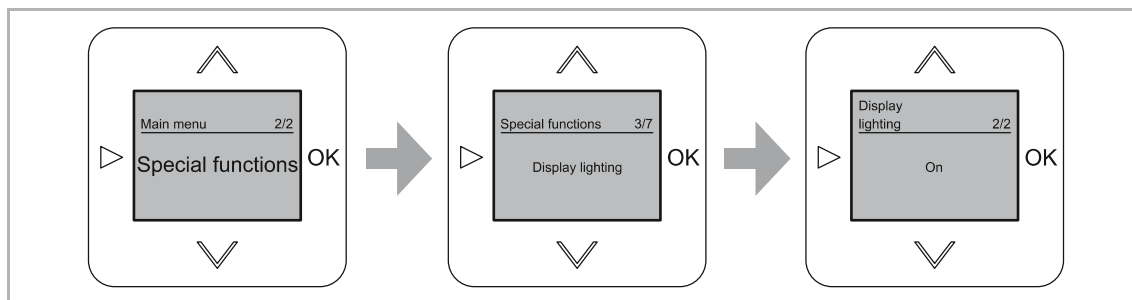

Fig. 31: Menu item "Illumination"

In this menu the desired display illumination is set.

Select from the following setting options:

Menu function	Description
ON	The display is permanently illuminated.
Automatic	After the press of a button the display activates itself for one minute.

Table 6: Display illumination

Setting the display illumination

1. Select menu "Special functions".
2. Select menu "Display illumination".
3. Select the desired setting with the "UP / DOWN" buttons.
4. Confirm your setting with the "OK" button.

8.3.7 Menu "Temperature correcting value"

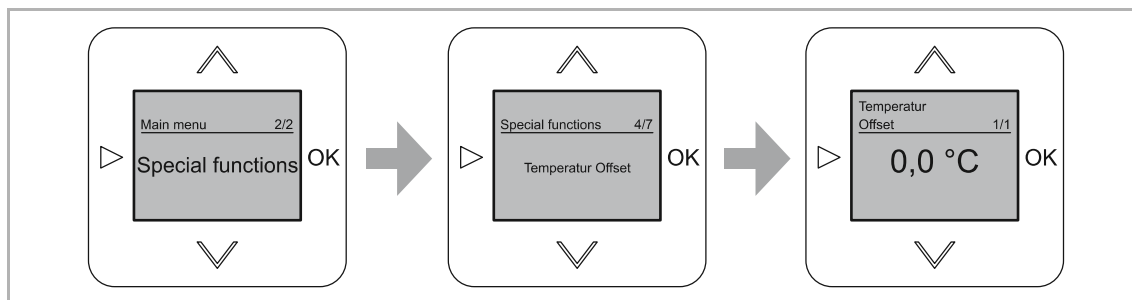

Fig. 32: Menu "Temperature correcting value"

A correcting value for the measured temperature is entered in this menu.

Correcting value	Information
Temperature	<p>If the measure temperature value is permanently influenced by external factors, a correcting value can be entered. The displayed temperature is then adjusted by the correcting value.</p> <ul style="list-style-type: none"> The correcting value can be set on the device between -5°C and $+5^{\circ}\text{C}$ in steps of 0.5°C.

Entering the correcting value for the temperature

1. Select menu "Special functions".
2. Select menu "Temperature offset".
 - The display shows the preset value.
3. Set the desired value with buttons "UP / DOWN".
 - This setting is configured in steps of 0.5°C .
4. Confirm your setting with the "OK" button.

8.3.8 Menu "CO₂ correcting value"

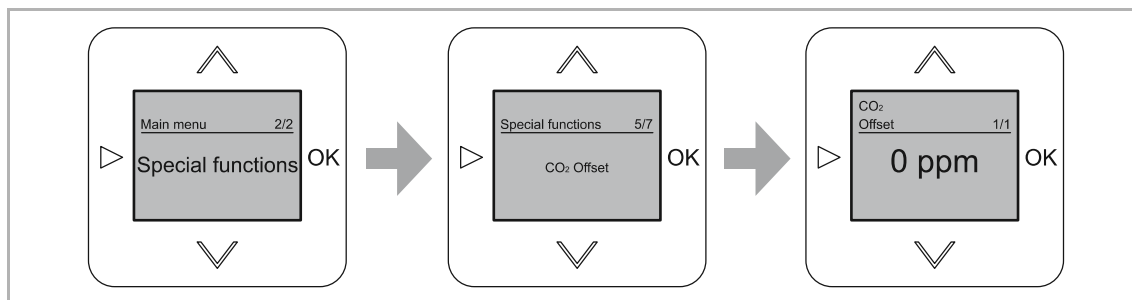

Fig. 33: CO₂ correcting value

A correcting value for the measured CO₂ is entered in this menu.

Correcting value	Information
CO ₂	<p>If the measured CO₂ value is permanently influenced by external factors, a correcting value can be entered. The displayed CO₂ value is then adjusted by the correcting value.</p> <ul style="list-style-type: none"> The correcting value can be set on the device between -800 ppm and +800 ppm in steps of 10 ppm.

Entering the correcting value for the CO₂ value

1. Select menu "Special functions".
2. Select menu "CO₂ offset".
 - The display shows the preset value.
3. Set the desired value with buttons "UP / DOWN".
 - This setting is configured in steps of 10 ppm.
4. Confirm your setting with the "OK" button.

8.3.9 Menu "Load current"

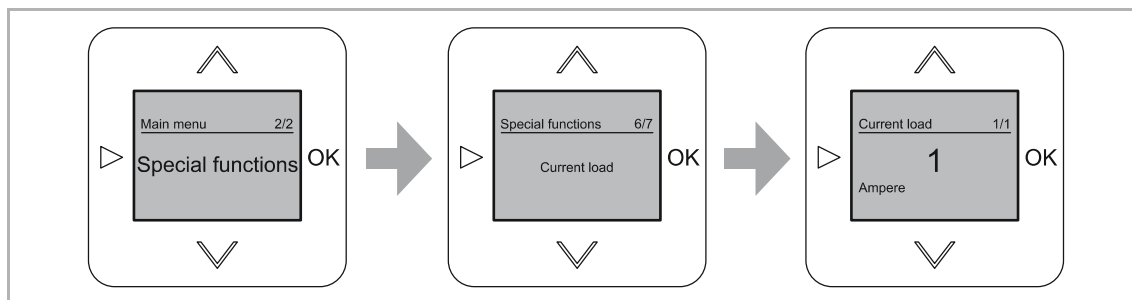

Fig. 34: Load current

In this menu the current for the load to be switched is entered.

Value	Information
Load current	<p>If high electric loads are controlled with the device, the high current heats up the device and the displayed temperatures and the RH value are no longer correct. With the entry of the load current, this value is used as the correcting value of the displayed temperature and the relative humidity.</p> <ul style="list-style-type: none"> The load current can be set on the device between 1 ampere and 6 ampere in steps of 1 ampere.

Entering the load current

1. Select menu "Special functions".
2. Select menu "Load current".
 - The display shows the preset value.
3. Set the desired value with buttons "UP / DOWN".
 - This setting is configured in steps of 1 A.
4. Confirm your setting with the "OK" button.

8.3.10 Menu "Manual operation"

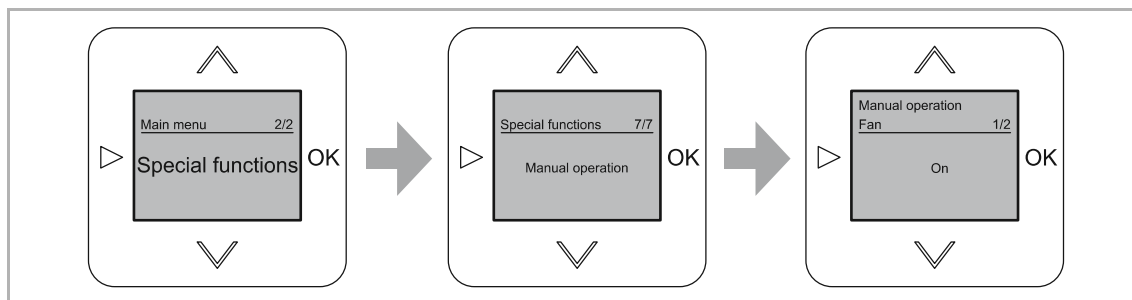

Fig. 35: Manual operation

In this menu an additional operation of the window or the ventilation is made possibly by hand.

Value	Information
Manual operation ON	<p>Window control: The window can be opened or closed by the device in addition to the automatic control.</p> <ul style="list-style-type: none"> – Opening / closing is carried out via the "Up" / DOWN" buttons on the device. <p>Fan control: The fan can be switched to levels 1 and 2 by the device in addition to the automatic control.</p> <ul style="list-style-type: none"> – Switching is carried out via the "Up" / DOWN" buttons on the device.
Manual operation OFF	<p>The window or the fan is controlled exclusively via the device.</p> <ul style="list-style-type: none"> – The windows cannot be opened / closed by hand. – The ventilation cannot be switched on / off by hand.

Activating / deactivating the manual operation.

1. Select menu "Special functions".
2. Select menu "Manual operation".
 - The display shows the preset value.
3. Set the desired value with buttons "UP / DOWN".
4. Confirm your setting with the "OK" button.

8.3.11 RESET (resetting the device)

If you wish to delete all the settings you have made and to re-enter them, the device must first be fully reset to its state at the point of delivery.

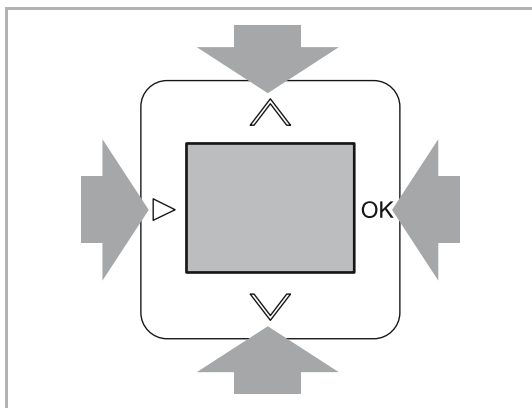

Fig. 36: Resetting the device

1. Press all four buttons on the device simultaneously for at least 5 seconds.
 - The device switches to the "Reset" function.
 - If you do not wish to perform the reset, the menu is exited with the "CHANGE" button.
2. Confirm the confirmation request with the "OK" button.
 - The device switches to the "Setup" function.
 - All settings of your device have now been reset.
3. Set the device anew, see chapter 7 "Commissioning" on page 18.
 - After the new entry the device performs a calibration and switches to standard operation.



NOTE

When the key lock is active, no reset is possible.

8.4 Operation manual mode

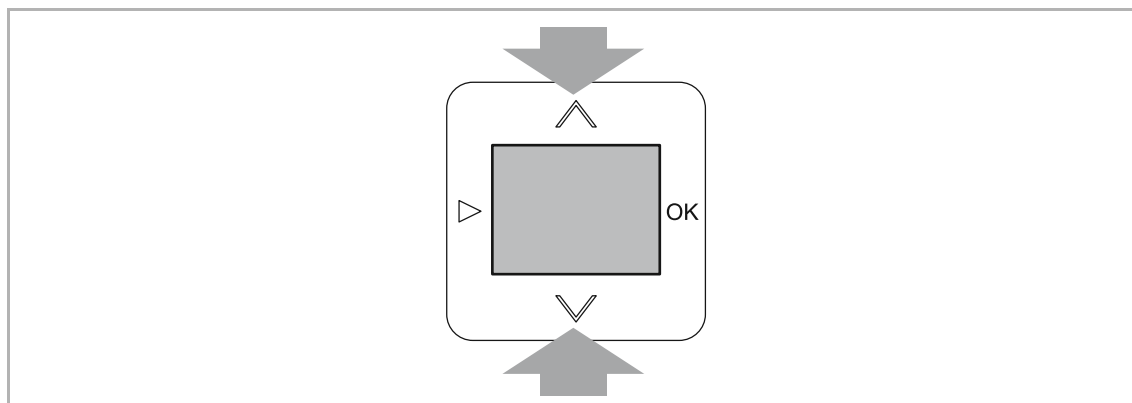

Fig. 37: Manual mode

The set ventilation can also be controlled by hand via the "UP / DOWN" buttons of the device. This function is only available if it has been set up in the special functions, see chapter 8.3.10 "Menu "Manual operation"" on page 34. It can be deactivated there if this function is no longer desired.

Operation of fan function	Function
1. Press the "UP" button	Fan to level 1
2. Press the "UP" button	Fan to level 2
1. Press the "DOWN" button	Fan to level 1
2. Press the "DOWN" button	Fan off

Table 7: Manual mode of fan function

Operation of window function	Function
1. Press the "UP" button	The window opens. – The open command remains active for 3 minutes
2. Press the "UP" button	The open command is switched off. – This interrupts the opening of the window. It is opened only partly.
1. Press the "DOWN" button	The window closes. – The close command remains active for 3 minutes
2. Press the "DOWN" button	The close command is switched off. – This interrupts the closing of the window. It is closed only partly.

Table 8: Manual mode of window function

9 Maintenance

9.1 Cleaning

**Caution! - Risk of damaging the device!**

- When spraying on cleaning agents, these can enter the device through crevices.
 - Do not spray cleaning agents directly onto the device.
- Aggressive cleaning agents can damage the surface of the device.
 - Never use caustic agents, abrasive agents or solvents.

Clean dirty devices with a soft dry cloth.

- If this is insufficient, the cloth can be moistened slightly with a soap solution.

10 Information about planning and application

10.1 Menu tree

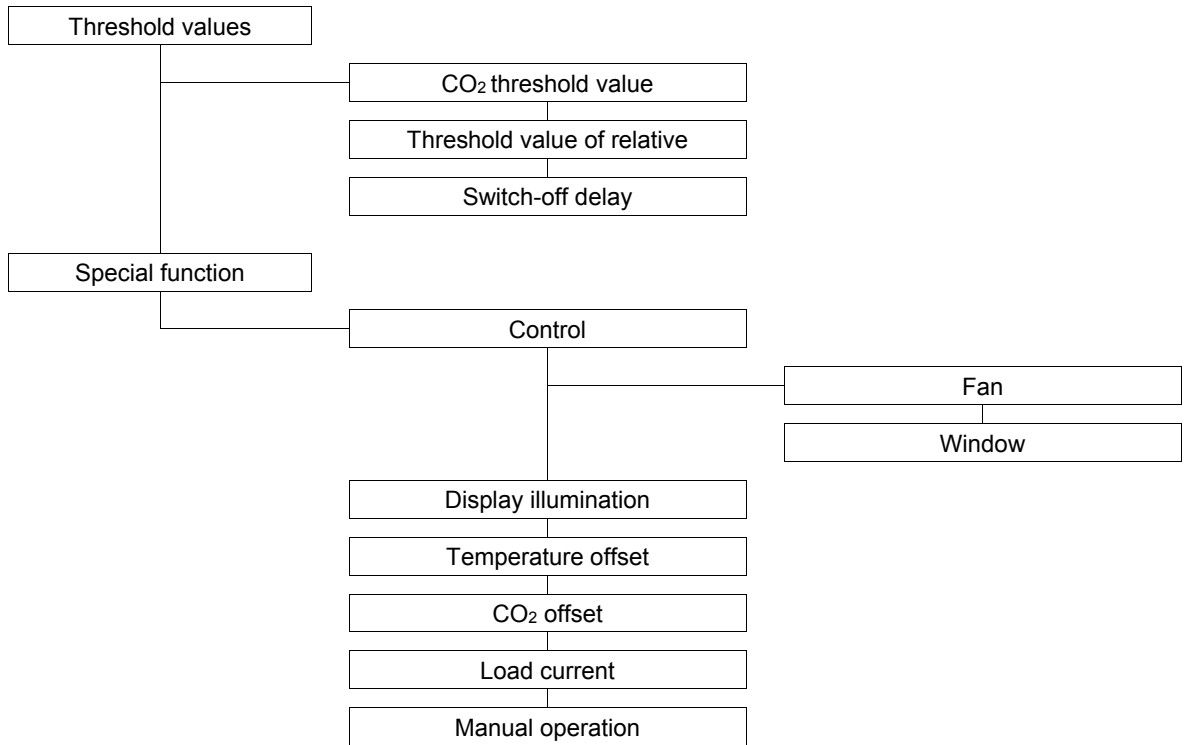

11 Index

B	
Button assignment	26
Button lock	24
C	
Calibration	21
Change into extended operation	26
Cleaning	37
CO2 correcting value	10, 32
Commissioning	18, 35
Connection, installation / mounting	14
D	
Display	21, 26
E	
Electrical connection	16, 17
Environment	9
Extended operation	20, 26
F	
Factory settings	13
Fan control	19, 29
Functions	10
I	
Improper use	6
Information about planning and application	38
Information and symbols used	5
Information on protection of the environment	9
Intended use	6
L	
Language	18
Load current	33
M	
Maintenance	37
Manual mode	20, 36
Manual operation	34, 36
Menu "Display lighting"	30
Menu tree	38
Messages	21
Mounting	15
N	
Nachlaufzeit	19, 27
National language	18
Normal operation	20, 21
Notes on the instruction manual	4
O	
Operating modes	20
Operation	7, 20
P	
Possible combinations	11
Q	
Qualification of personnel	7
R	
Requirements for the electrician	14
RESET	35
Resetting the device	35
S	
Safety	5
Safety instructions	8
Setup and function	10
Störquellen	10
T	
Target group	7
Technical data	12
Temperature correcting value	10, 31
Threshold values	19, 27
W	
Window control	19, 29

A member of the ABB Group

Busch-Jaeger Elektro GmbH

PO box
58505 Lüdenscheid

Freisenbergstraße 2
58513 Lüdenscheid

www.BUSCH-JAEGER.de
info.bje@de.abb.com

Central sales service:
Tel.: +49 2351 956-1600
Fax: +49 2351 956-1700

Notice

We reserve the right to make technical changes at all times as well as changes to the contents of this document without prior notice. The detailed specifications agreed upon apply for orders. ABB accepts no responsibility for possible errors or incompleteness in this document.

We reserve all rights to this document and the topics and illustrations contained therein. The document and its contents, or extracts thereof, must not be reproduced, transmitted or reused by third parties without prior written consent by ABB

Copyright© 2016 Busch-Jaeger
Elektro GmbH
All rights reserved