

LEANtouch (monochrome),
SMARTtouch (monochrome, colour)
Type: 6136/30M-500, 6136/100M-500,
6136/100C-500, 6136/100CB
6936/30M, 6936/100M,
6936/100C, 6936/100CB

Intelligent Installation Systems



Contents

LEANtouch (monochrome)	6x36/30M(-500)	2 - 4
SMARTtouch (monochrome)	6x36/100M(-500)	2 - 5
SMARTtouch (colour)	6x36/100C(-500)	2 - 6
SMARTtouch B&O	6x36/100CB	2 - 7
Application programs		2 - 8
Circuit diagram		2 - 8
Installation of the supplementary software		2 - 9
Functions of the panel software		2 - 11
Functional description: Basic settings		2 - 14
Functional description: Touch surfaces (Homepage)		2 - 18
Functional description: Touch surfaces (Control page)		2 - 26
Functional description: Time programs		2 - 41
Functional description: IR control		2 - 46
Functional description: Room thermostat		2 - 52
Functional description: Lightscenes		2 - 61
Functional description: Alarm function		2 - 64
Functional description: Presence simulation		2 - 66
Functional description: Logical functions		2 - 67

ABB i-bus® EIB
ABB Powernet EIB

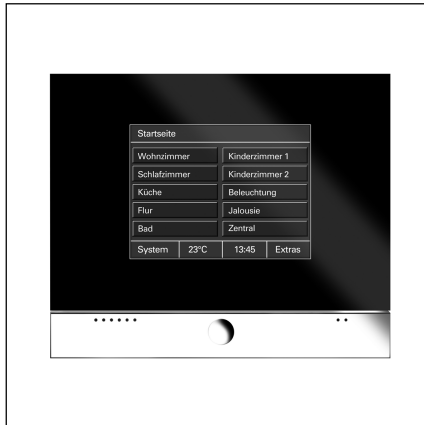

The LEANtouch panel is a high-quality EIB touch-sensitive display. The panel offers approx. 30 operator functions with a monochrome display. It is used as a control, monitoring and indication unit for the complete EIB installation which can be operated across different rooms.

The touch-sensitive display is set in a black, high-gloss frame and has backlighting available. The integrated loudspeaker can e.g. feed back operations acoustically or signal alarm and fault messages.

The panel has a pen for operation and a slot for a multimedia/SD card.

The operation and control is carried out in a clear menu structure via the touch surfaces which are labelled in clear text. The functional assignment of the touch surfaces can be created individually and is dependent on the parameterisation.

All the functions of the panel are listed in the table below "Functional overview" (see below).

Technical Data

Power supply	– Nominal voltage	230 V AC $\pm 10\%$
	– Bus voltage (TP only)	24 V DC
	– Power consumption	10 W
Operating and display elements	– Touch-sensitive display	320 x 240 pixels 16 grey shades (monochrome)
Connections	– Power supply	Screw plug-in terminals up to 2.5 mm ²
	– EIB bus connection (TP only)	Screw plug-in terminals up to 1.5 mm ²
	– Multimedia/SD card	1 module slot at the front
Type of protection	– IP 20, EN 60 529	
Protection class	– II	
Ambient temperature range	– Operation	0 °C to + 45 °C
	– Storage and transport	- 20 °C to + 60 °C
Dimensions	– Panel with cover frame	184.6 x 218 mm (H x W)
	– Flush-mounted box	163.5 x 199 x 60 (H x W x D)
Weight	– 0.742 kg	
Certification	– EIB-certified	
CE norm	– in accordance with the EMC guideline and the low voltage guideline	

Functional overview

– Number of touch surfaces (possible control pages) on Homepage	6
– Number of possible functions per control page	5
– Total of operator functions	30
– Scope of time programs	5 channels, 5 switching times each
– Scope of scenes	32 scenes with max. 10 objects (loads)
– Number of alarm signals	5
– Presence simulation	max. 10 devices
– IR remote control channels	10
– Integrated room thermostat	
– Child protection	
– Number of logic functions (AND, OR, NAND, NOR, multiplexer, multiplier, GATE, temperature comparator)	10

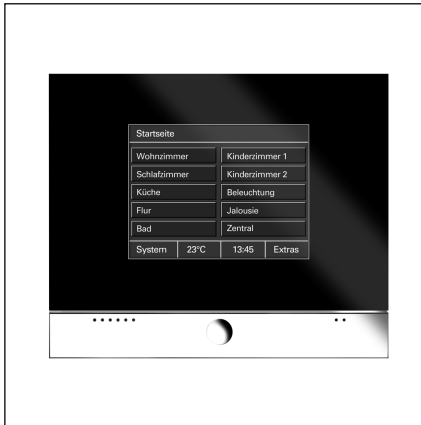

The SMARTtouch panel is a high-quality EIB touch-sensitive display. The panel offers approx. 100 operator functions with a monochrome display. It is used as a control, monitoring and indication unit for the complete EIB installation which can be operated across different rooms.

The touch-sensitive display (either in colour or black/white) is set in a black, high-gloss frame and has backlighting available. The integrated loudspeaker can e.g. feed back operations acoustically or signal alarm and fault messages.

The panel has a pen for operation and a slot for a multimedia/SD card.

The operation and control is carried out in a clear menu structure via the touch surfaces which are labelled in clear text. The functional assignment of the touch surfaces can be created individually and is dependent on the parameterisation.

All the functions of the panel are listed in the table below "Functional overview" (see below).

Technical Data

Power supply	– Nominal voltage	230 V AC \pm 10%
	– Bus voltage (TP only)	24 V DC
	– Power consumption	10 W
Operating and display elements	– Touch-sensitive display	320 x 240 pixels 16 grey shades (monochrome)
Connections	– Power supply	Screw plug-in terminals up to 2.5 mm ²
	– EIB bus connection (TP only)	Screw plug-in terminals up to 1.5 mm ²
	– Multimedia/SD card	1 module slot at the front
Type of protection	– IP 20, EN 60 529	
Protection class	– II	
Ambient temperature range	– Operation	0 °C to + 45 °C
	– Storage and transport	- 20 °C to + 60 °C
Dimensions	– Panel with cover frame	184.6 x 218 mm (H x W)
	– Flush-mounted box	163.5 x 199 x 60 (H x W x D)
Weight	–	0.742 kg
Certification	–	EIB-certified
CE norm	–	in accordance with the EMC guideline and the low voltage guideline

Functional overview:	– Number of touch surfaces (possible control pages) on Homepage	10
	– Number of possible functions per control page	10
	– Total of operator functions	100
	– Scope of time programs	20 channels, 10 switching times each
	– Scope of scenes	32 scenes with max. 20 objects (loads)
	– Number of alarm signals	10
	– Monitoring function	Monitoring of up to 30 signalling inputs (e.g. window contacts, movement detectors)
	– Presence simulation	max. 10 devices
	– IR remote control channels	10
	– Integrated room thermostat	
	– Info function	
	– Timer function	
	– Child protection	
	– Number of logic functions (AND, OR, NAND, NOR, multiplexer, multiplier, GATE, temperature comparator)	20

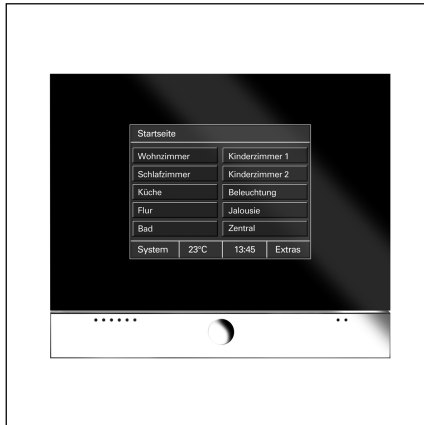

The SMARTtouch panel is a high-quality EIB touch-sensitive display. The panel offers approx. 100 operator functions with a colour display. It is used as a control, monitoring and indication unit for the complete EIB installation which can be operated across different rooms.

The touch-sensitive display (either in colour or black/white) is set in a black, high-gloss frame and has backlighting available. The integrated loudspeaker can e.g. feed back operations acoustically or signal alarm and fault messages.

The panel has a pen for operation and a slot for a multimedia/SD card.

The operation and control is carried out in a clear menu structure via the touch surfaces which are labelled in clear text. The functional assignment of the touch surfaces can be created individually and is dependent on the parameterisation.

All the functions of the panel are listed in the table below "Functional overview" (see below).

Technical Data

Power supply	– Nominal voltage	230 V AC $\pm 10\%$
	– Bus voltage (TP only)	24 V DC
	– Power consumption	10 W
Operating and display elements	– Touch-sensitive display	320 x 240 pixels 16 grey shades (monochrome)
Connections	– Power supply	Screw plug-in terminals up to 2.5 mm ²
	– EIB bus connection (TP only)	Screw plug-in terminals up to 1.5 mm ²
	– Multimedia/SD card	1 module slot at the front
Type of protection	– IP 20, EN 60 529	
Protection class	– II	
Ambient temperature range	– Operation	0 °C to + 45 °C
	– Storage and transport	- 20 °C to + 60 °C
Dimensions	– Panel with cover frame	184.6 x 218 mm (H x W)
	– Flush-mounted box	163.5 x 199 x 60 (H x W x D)
Weight	– 0.742 kg	
Certification	– EIB-certified	
CE norm	– in accordance with the EMC guideline and the low voltage guideline	

Functional overview:

– Number of touch surfaces (possible control pages) on Homepage	10
– Number of possible functions per control page	10
– Total of operator functions	100
– Scope of time programs	20 channels, 10 switching times each
– Scope of scenes	32 scenes with max. 20 objects (loads)
– Number of alarm signals	10
– Monitoring function	Monitoring of up to 30 signalling inputs (e.g. window contacts, movement detectors)
– Presence simulation	max. 10 devices
– IR remote control channels	10
– Integrated room thermostat	
– Info function	
– Timer function	
– Child protection	
– Number of logic functions (AND, OR, NAND, NOR, multiplexer, multiplier, GATE, temperature comparator)	20

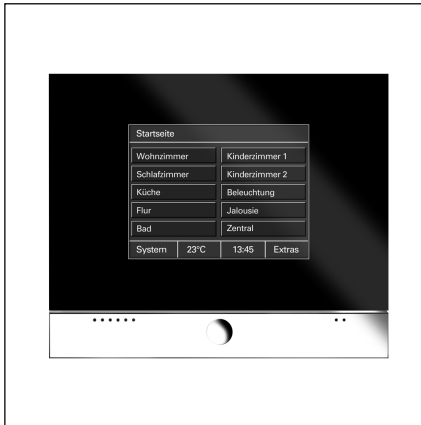

The SMARTtouch panel is a high-quality EIB touch-sensitive display. The panel offers approx. 100 operator functions with a colour display. It is used as a control, monitoring and indication unit for the complete EIB installation which can be operated across different rooms.

The touch-sensitive display (either in colour or black/white) is set in a black, high-gloss frame and has backlighting available. The integrated loudspeaker can e.g. feed back operations acoustically or signal alarm and fault messages.

The panel has a pen for operation and a slot for a multimedia/SD card.

The operation and control is carried out in a clear menu structure via the touch surfaces which are labelled in clear text. The functional assignment of the touch surfaces can be created individually and is dependent on the parameterisation.

The SMARTtouch B&O panel is identical to the "standard" SMARTtouch panel. In addition, it can be controlled remotely via a Bang & Olufsen remote control Beo4 e.g. to retrieve a lightscene in the panel. The SMARTtouch B&O panel can further also be operated via the Busch-Jaeger IR remote control.

All the functions of the panel are listed in the table below "Functional overview" (see below).

Technical Data

Power supply	– Nominal voltage	230 V AC \pm 10%
	– Bus voltage (TP only)	24 V DC
	– Power consumption	10 W
Operating and display elements	– Touch-sensitive display	320 x 240 pixels 256 colours
Connections	– Power supply	Screw plug-in terminals up to 2.5 mm ²
	– EIB bus connection (TP only)	Screw plug-in terminals up to 1.5 mm ²
	– Multimedia/SD card	1 module slot at the front
Type of protection	– IP 20, EN 60 529	
Protection class	– II	
Ambient temperature range	– Operation	0 °C to + 45 °C
	– Storage and transport	- 20 °C to + 60 °C
Dimensions	– Panel with cover frame	184.6 x 218 mm (H x W)
	– Flush-mounted box	163.5 x 199 x 60 (H x W x D)
Weight	–	0.742 kg
Certification	–	EIB-certified
CE norm	–	in accordance with the EMC guideline and the low voltage guideline

Functional overview:

– Number of touch surfaces	10
– (possible control pages) on Homepage	
– Number of possible functions per control page	10
– Total of operator functions	100
– Scope of time programs	20 channels, 10 switching times each
– Scope of scenes	32 scenes with max. 20 objects (loads)
– Number of alarm signals	10
– Monitoring function	Monitoring of up to 30 signalling inputs (e.g. window contacts, movement detectors)
– Presence simulation	max. 10 devices
– IR remote control channels	10
– Integrated room thermostat	
– Info function	
– Timer function	
– Child protection	
– Number of logic functions	20
– (AND, OR, NAND, NOR, multiplexer, multiplier, GATE, temperature comparator)	

Application programs	Number of communication objects	Max. number of group addresses	Max. number of associations
for LEANtouch/SMARTtouch panel Twisted Pair: Panel TP/1	approx. 500	approx. 4000	approx. 4000
for LEANtouch/SMARTtouch panel Powernet: Panel PL/1	approx. 500	approx. 4000	approx. 4000

Note

If the SMARTtouch panel 6x36/100CB should be used, there is no separate entry for it in the ETS or Power-Project database.

In this case, the SMARTtouch panel 6x36/100C must be used. The difference between them is that the SMARTtouch panel 6x36/100CB can react to signals of the Bang&Olufson IR remote control Beo4. (See also *IR control*)

Circuit diagram

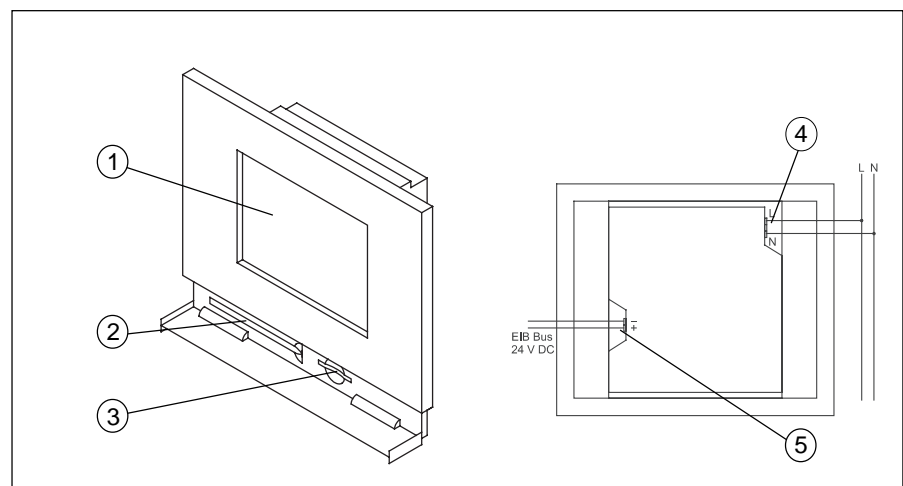

- 1 Touch-sensitive display 320 x 240 pixels, colour
- 2 Operating pen

- 3 MMC/SD card reader
- 4 230 V power supply
- 5 24 V EIB bus voltage (TP only)

Note

Do not lead any live cables behind the device through the flush-mounted box. Separation of the TP bus and mains cable!

Installation of the supplementary software (RCP tool)

To be able to parameterise the LEANtouch or SMARTtouch panel in ETS 2, in ETS 3 or in Power-Project (from version 4.0 onwards), the supplementary software RCP-Tool must be installed. You can find this software on the EIB product database CD-ROM (art. no. 0405) or on the Internet at www.Busch-Jaeger.de.

The software can be plugged into ETS 2, ETS 3 and/or Power-Project. That means that as soon as you retrieve the parameters of a panel in ETS or Power-Project, the panel software is opened automatically in which you carry out all further settings.

Before you start the installation of the panel software, please ensure that ETS or Power-Project has already been installed on your computer.

The following section describes the individual installation steps.

An installation wizard helps you to install the panel software. This is started by double clicking on the file "Setup.exe" and can run in either "German" or "English".

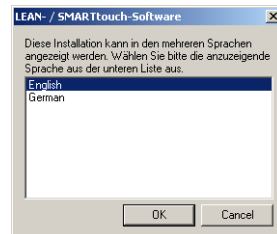

The panel software requires at least Windows 98. You require full administrator rights of the operating system in order to install the panel software.



Once you have confirmed the welcome screen with "Next", you can enter your name and the name of your company in the "User info" dialog. If several users work on the computer on which you wish to install the software, you can limit access to the software. This means that either all the users can start the software or only you.

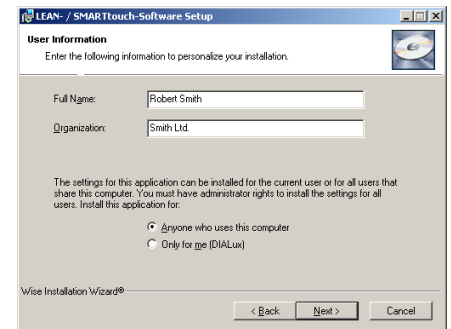

The installation path for the panel software is defined in the next dialog. By default, this is "C:\Program Files\EIB-Programs\". It is advisable to keep this path as e.g. Power-Project has the same default installation path. All EIB programs and additional EIB software can thus be easily located on the hard disk.

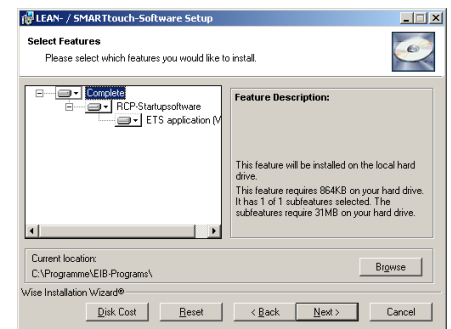

In the “Select functions” dialog, you define whether the VD2 or VD3 files should be copied locally onto the hard disk. You require these to be able to use the LEANtouch/SMARTtouch panel in connection with an ETS version. (Also observe the note at the end of this chapter).

By default, the files are copied into the following directory:
C:\Program Files\EIB-Programs\RCP-Tool\VDX

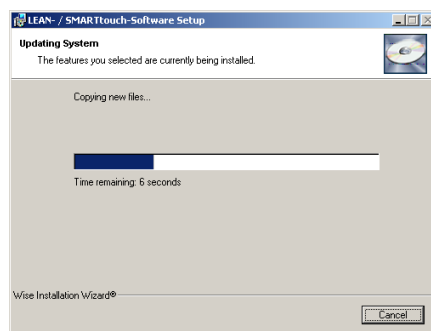

Once you have confirmed the “Select functions” dialog with “Next”, the installation wizard carries out an initialisation. This means that all the required files are compiled together and stored temporarily. The dialog “Updating the system” is shown for visual monitoring purposes.

All the required files are then copied into the appropriate directories. The installation is concluded with an automatic amendment of the Windows registration entries.



The computer must be restarted depending on the operating system used.

Note

Once you have installed the panel software, you must import the product data (VD2 or VD3 files) in the ETS database if you wish to parameterise a panel with ETS.

To do so, please retrieve the ETS import tool (ETS 2 or ETS 3) and import the VD2 (ETS 2) or VD3 files (ETS 3) from the default directory
C:\Program Files\EIB-Programs\RCP-Tool\VDX.

You must import the VD2 or VD3 files in full.

Caution:
The import of individual files is not possible.

Commissioning a panel

The commissioning of a panel is possible either via a multimedia/SD card (not included) or with “standard” bus programming.

Due to the high level of functionality, full programming via the bus takes a long time depending on the configuration and medium (Twisted Pair or Powernet). **The use of the multimedia/SD card is therefore recommended for quick and simple commissioning.** It is not advisable to carry out full bus programming via Powernet.

The menu item “Download” of the commissioning tool therefore has two further submenus via which the user can select the required commissioning method. If he selects programming via multimedia card, the configuration is stored on a card which is connected to the PC.

With a project that is saved in this way, the panel itself can be commissioned by inserting the card. The slot for the multimedia/SD card is located behind the chrome flap of the panel.

Several projects can be stored on one multimedia card. After inserting the card in the panel, the user can select the required project which should be loaded into the panel.

Functions of the panel software

If you have inserted a LEANtouch or SMARTtouch panel in Power-Project or in ETS, open the panel software by retrieving the “Edit device” dialog (Power-Project) or the parameters (ETS) of the panel. The panel software starts automatically with the following interface.

The method of operation of the panel software is identical to that of Power-Project or ETS. The “standard” group

addresses and the internal group addresses are arranged on the left-hand side. Internal group addresses are not sent on the bus and are therefore used to relieve the load on the bus. A touch surface can for example be linked with a lightscene via an internal group address. The group addresses and the internal group addresses are linked with the communication objects in the centre using drag & drop.

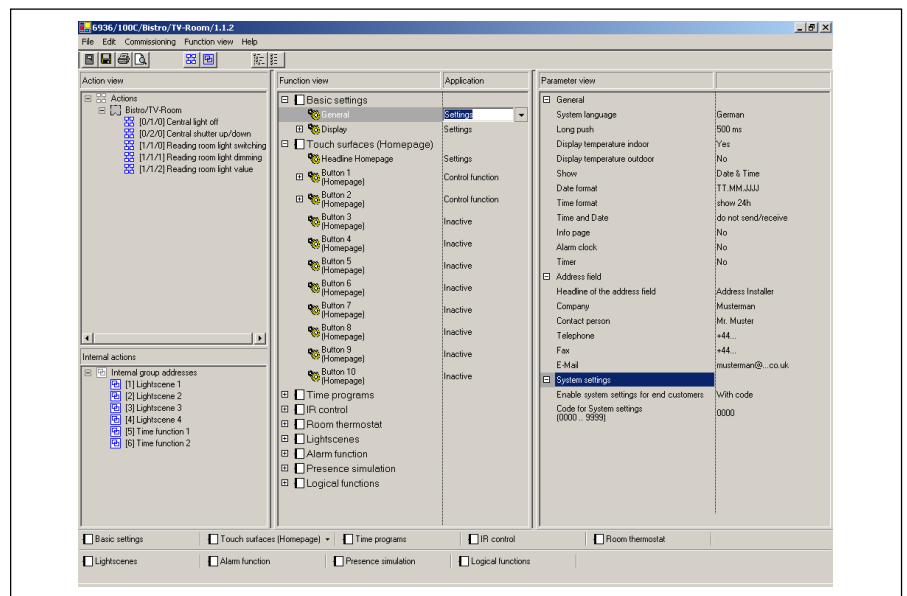

The functions and applications are arranged with all the communication objects in the centre. If necessary, the individual functions/applications must first be activated so that the communication objects become visible. The functions are defined via a pull-down menu.

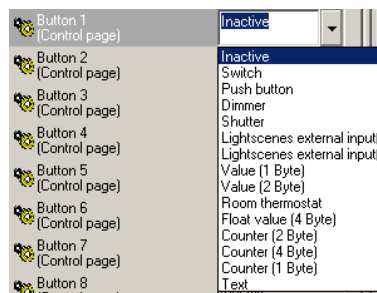

The parameters of the individual functions are displayed on the right-hand side. The parameters of the function that is marked in the centre are always displayed.

To obtain a better overview, individual functions can be temporarily hidden via the function view.

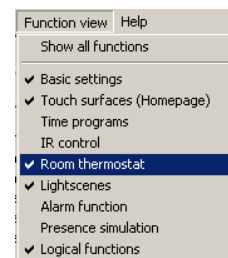

The buttons at the bottom always jump directly to the selected function. This is particularly advisable if the function tree in the centre has been fully extended.

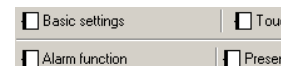

Functions of the panel software

Copying a panel

Only one panel can be parameterised at one time. To provide several panels with the same functionality (generation of a duplicate of a previously configured panel), please proceed as follows:

Retrieve the function “Save as...” from the File menu. The project is stored with the file ending *.rcp. Now close the panel software. Please insert a new panel in ETS or Power-Project. This can be in the same or another project. Then open the panel software for the inserted panel. Select the function “Open” in the File menu and select the previously saved file.

Please note that you can load the data of a **LEANtouch panel** into a **SMARTtouch panel** but not vice versa.

During the import, the following window is displayed in which you can select whether the import should be carried out with or without group addresses.

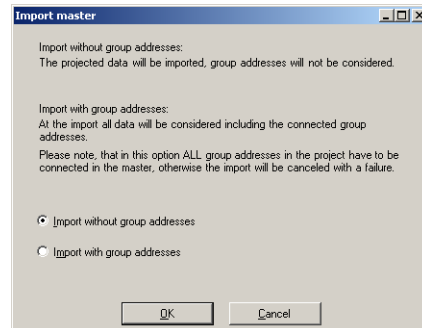

During an import with group addresses, you must ensure that all the group addresses or actions are already located in the project with identical EIS types to the template. Otherwise, you can only import the data without group addresses. You must then however link them again.

Auto backup file

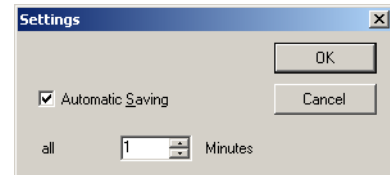

When you retrieve the menu item “Settings” under the File menu, you can set the period, after which the panel software will carry out an automatic backup. This is a temporary file which is stored on your hard disk.

If e.g. your computer crashes, you can retrieve the last automatic backup with the menu item “Reset” under the File menu.

Copying functions

To shorten the configuration time, it is possible to copy the settings of a function (touch surface, time function, lightscene). To do so, click on the function with the right mouse button which should be copied.

Note:

Only touch surfaces with identical applications or functions can be duplicated.

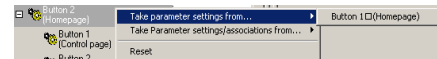

Parameter	Switch time 1	Switch time 2	Switch time 3
Time	00:00	Copy time program	00:00
Weekday	Monday to Frid	Edit time program	Monday to Frida
Status	Off/Up	Reset time program	Off/Up
Astro	Inactive	Inactive	Inactive
Locking	not before .. o'clock	not before .. o'clock	not before .. o'cl
Blocking time	00:00	00:00	00:00
Switching function	always inactive	always inactive	always inactive

ABB i-bus® EIB
ABB Powernet EIB

LEANTouch (monochrome),
SMARTTouch (monochrome, colour)
Type: 6x36/30M(-500), 6x36/100x(-500), 6x36/100CB

Functions of the panel software

Important note

**If you have inserted a LEANTouch/
SMARTTouch panel in ETS 2, you may
no longer retrieve the following
function:**

- **Shrink database**

The reason for this lies in the database structure of ETS 2. It is not large enough to take all the panel information. The panel information is stored temporarily in several files on the hard disk. **If you carry out the function mentioned above, the files are no longer taken into account and the result is data loss or damage to the database.**

For ETS 2 users:

After importing an ETS 2 project with a LEANTouch/SMARTTouch panel, a database consistency check must be carried out in any case. Otherwise, the panel is not displayed correctly/fully within the framework of the commissioning process.

Functional description: Basic settings

Background illumination

The backlighting of the panel is switched on automatically as soon as the display is operated. After the adjustable period "Background illumination on for", the lighting is switched off again provided that the panel has not been pressed again.

The panel has three communication objects in the basic settings. All three objects are used to control the backlighting and are 1 bit in size.

The backlighting can be switched via the object "Background illumination". A ON telegram received via the EIB switches the backlighting on while an OFF telegram switches it off again.

The object can however also be linked with an internal address.

Example:

The panel backlighting should always switch on at 18:00 in the evening and switch off again at 10:00 in the morning. To do so, a channel of the time program function is parameterised with switching and the switch object of the channel is linked with the same internal address as the background illumination object. The bus load is reduced on the EIB side due to the internal link and group addresses or actions are saved.

The object "Status background illumination" sends an ON telegram as soon as the backlighting has been switched on. If the backlighting switches off again after the set reset period, the object sends an OFF telegram.

The backlighting can be disabled via the object "Enable status". If an ON telegram is received, the backlighting can be switched. If an OFF telegram is received, the backlighting remains disabled.

General

By default, the panel has the languages German and English. The display language can be set to a third language via the setting "Country-specific". This third language must be transferred to the panel via a firmware update. The additional languages available can be downloaded from the Busch-Jaeger homepage (www.Busch-Jaeger.de).

The panel distinguishes between a short and long push button action e.g. when dimming or moving shutters. It is possible to set the period which the panel detects as a long push button action. By default, the period is set at 500 ms.

The panel has an internal temperature sensor. The measured value is displayed on the homepage. The display can also be deactivated via the setting "Display temperature indoors".

The outside temperature is not displayed by default. The display can be activated via the display "Display temperature outdoors". The outside temperature is the temperature value which the panel receives via the 2-byte communication object "Temperature outside". It can be recorded e.g. by a "standard" EIB temperature sensor and sent via its 2-byte communication object "Actual value".

If the indoor and outdoor temperature should be displayed simultaneously, the corresponding point on the display changes every 5 s.

The panel can display the date and time. The display can be carried out in the German format (TT.MM.JJJJ; 24h) or in the English format (MM.TT.JJJJ; 12h).

The panel can send and receive the date and time on the EIB via the two 3-byte communication objects "Date" and "Time". The panel can thus act as a master clock for other EIB devices or as an extension unit. In its function as an extension unit, the date and time can e.g. be sent by an EIB DCF-77 receiver on the bus. By default, the date and time are neither sent nor received.

If the date **and** the time should be displayed on the panel, the corresponding display switches between date and time every 5 s.

The panel has an info page, an alarm clock and a timer. All three functions can be activated in the basic settings.

Address page

The contact person, company, telephone, fax and email of the electrical company which carried out the installation can be stored on the address page. In the event of changes, the customer (end user) does not need to search in his documentation to find the right contact person. He will find all the relevant data directly in the panel.

System settings

The system settings are not enabled as standard. This means that a four digit code (by default 0000) must be entered on the display so that changes can be carried out. Only authorised personnel may therefore view and modify the system settings. It is possible however to enable the system settings in principle e.g. in enclosed rooms with users who are permitted to carry out settings. The system settings can also be fully disabled.

Caution:

If you disable the system settings completely, the menu item "Commissioning" on the panel can no longer be selected. In this case, you must carry out a long operation at the bottom left of the display and thereby switch on the mains voltage. The menu item "System" becomes visible and the panel can e.g. be commissioned with the multimedia/SD card.

If the system settings are saved with the help of a code, the code is defined via the parameter "Code for system settings".

The following settings can be carried out in the system settings on the display:

- Change date
- Change time
- Display lighting
- Volume
- Contrast / brightness
- Signal tones
 - Alarm messages
 - Timer / alarm clock
 - Incorrect input
 - Push button click
- Touchscreen adjustment
- Commissioning
 - EIB programming
 - Reading multimedia/SD card

(see also diagram for modifying system settings)

Changing system settings directly on the LEANtouch/SMARTtouch panel display

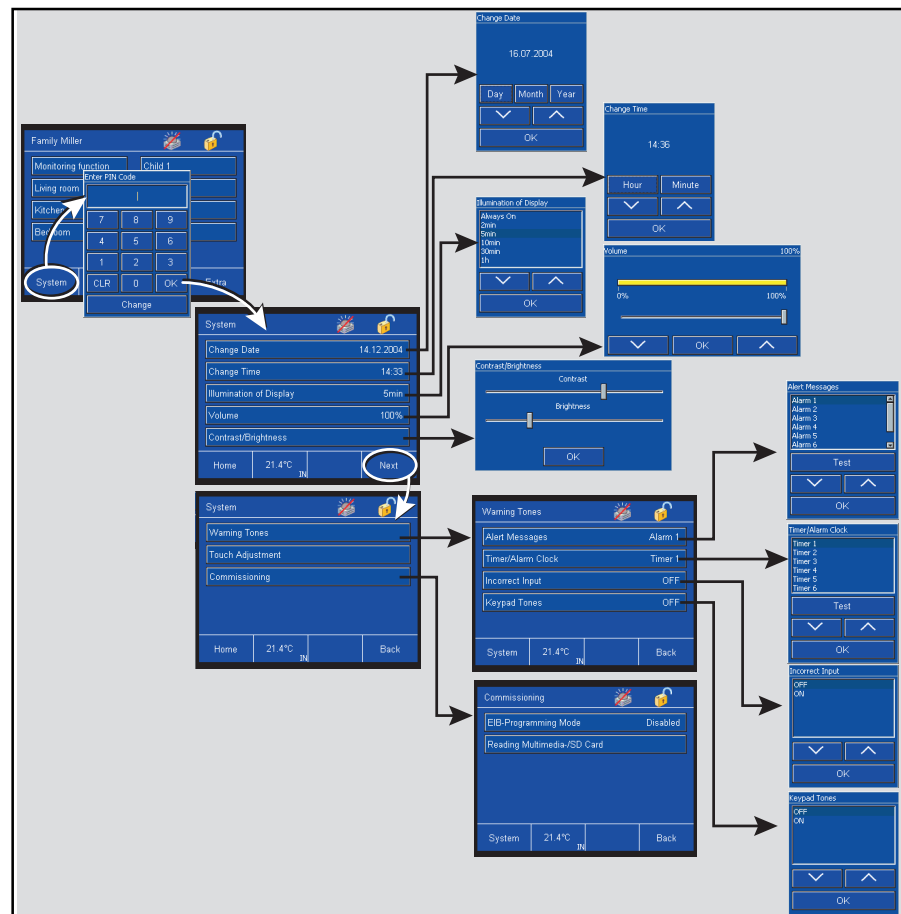

The time which has been stored in the parameter "Background illumination on for" is modified via "Background illumination".

The volume and the contrast or brightness must be adapted to the environment and requirements of the end user.

The complete touch surface is synchronised again with the touchscreen adjustment. To do so, the operating pen must be clicked precisely on specific points which are indicated on the display.

The commissioning can be carried out both via the EIB and via the multimedia/SD card module slot. **For Powernet variants, it is not advisable to carry out the programming via the bus as this is very time-consuming and faults caused by cyclical transmitters (e.g. room thermostats or movement detectors) can lead to the programming being interrupted.**

Communication objects

General (Outside temperature, date and time)

No.	Type	Object name	Function
0	2 byte	Temperature outside	Receive
1	3 byte	Date	Send/Receive
2	3 byte	Time	Send/Receive

Communication objects

for display illumination

No.	Type	Object name	Function
0	1 bit	Background illumination	Receive
1	1 bit	Status background illumination	Send
2	1 bit	Enable status	Receive

General parameters

The default setting for the values is printed in bold type.

General:	
- System language	German English Country-specific
- Long push	300 ms / 500 ms / 750 ms / 1 s
- Display temperature indoors	No / Yes
- Display temperature outdoors	No / Yes
- Show	Date Time Date & Time
- Date format	TT.MM.JJJJ MM.TT.JJJJ
- Time format	show 24 h show 12 h
- Time and Date	receive from the bus send to the bus do not send/receive
- Info page	No / Yes
- Alarm clock	No / Yes
- Timer	No / Yes
Address field:	
- Headline of the address field	"Address Installer"
- Company	"Mustermann"
- Contact person	"Mr. Muster"
- Telephone	" +44 ..."
- Fax	" +44 ..."
- E-mail	"mustermann@...co.uk"
System settings:	
- Enable system settings for end customers	Yes With code No ^{*1}
- Code for system settings (0000...9999)	0000

Display parameters

The default setting for the values is printed in bold type.

Display parameters:	
- Background illumination on for	always on 2 min 5 min 10 min 30 min 1 h

*1 Caution: Observe the note on page 15

Functional description: Touch surfaces (Homepage)

Homepage

The homepage of the panel is the first page which is shown by default. If a submenu (control function) has been retrieved via the touch surfaces, the panel automatically reverts to the last control page after a long period of inactivity.

The homepage can be provided with a heading which is defined via the setting "Headline Homepage".

No direct functions can be executed on the homepage itself. It is used as a navigation page in which you can change e.g. to the required rooms in order to carry out switching functions.

Touch surfaces

Up to 10 (6 for LEANtouch) touch surfaces can be displayed on the homepage. Each touch surface can at least adopt the function "Control function". The setting "Inactive" should only be selected if the touch surface is not used and should not display or monitor anything.

Touch surfaces (Control function)

If a touch surface on the homepage is assigned the application "Control function", a submenu can be retrieved in which up to 10 (6 for LEANtouch) further functions can be stored.

The text which appears on the touch surface is defined via the parameter "Name of touch surface (Homepage)".

Touch surfaces (Monitoring function)

The first touch surface of the SMARTtouch panel can be assigned with a monitoring function instead of a control function. In the dialog field "Monitoring function" which is retrieved via the first touch surface, the panel can be armed or deactivated and an overview of all the alarm and fault messages can be retrieved.

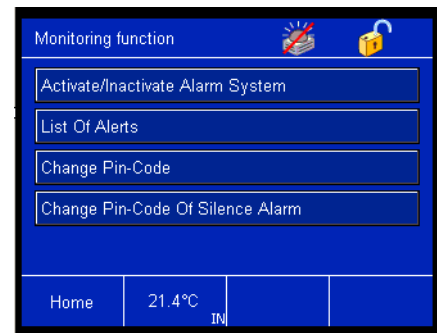

Note:

The monitoring function is not used to set up a VDS-certified alarm system but merely offers the opportunity of monitoring e.g. windows, doors or interior rooms via EIB-type movement detectors. It is **not** a replacement for an alarm system.

Inputs (Entry 1 up to 16, Monitoring function)

The monitoring function can monitor up to 16 inputs. Each input has its own 1-bit communication object available "Input ...". The parameter "Number of inputs" determines how many inputs are actually visible.

It can be set for each input via the parameter "Type of input" whether it is a window, a movement detector which may or may not be in the entrance area, a "standard" door or one of three doors in the entrance area. The setting should however only be seen as a configuration tool. All the inputs are treated the same internally in the panel, regardless of the "Type of input" assigned.

Text can be freely assigned to each individual input via the parameter "Description of the input". If an input is now triggered on the panel, not only the input number is shown but also a clear text description such as "Bathroom window open".

The input objects are linked via group addresses with the sensor objects (binary inputs, magnetic contacts, switch/key bolt contact, ...) of the window, movement detector or doors that are to be monitored. The linked sensors must send their input signals, both "0" and "1", cyclically on the bus so that the panel knows the status of the installation at any time.

If e.g. a movement detector is prevented from detecting movements through sabotage, the panel notes the sabotaged movement detector as it has not sent out any telegrams within the "Monitoring time of inputs". The panel thus automatically sets the linked input to fault mode.

The "Monitoring time of inputs" can be adjusted and represents a compromise between a high bus load and system reliability. The monitoring time should be set too short, particularly in Powerline installations.

Note:

Set the cyclic period of the sensors (binary inputs or movement detectors) to sensible values.

Example:

- Monitoring time of the inputs:
10 min
- Cyclic period of the sensors:
4.5 min

It is therefore guaranteed that a telegram is received at least twice within the monitoring time.

If the mains voltage fails, the inputs initially remain inactive on mains voltage recovery. The time until the inputs become active is set via the parameter "Monitoring of inputs after mains voltage recovery".

If an ON telegram is set while the system is "armed", the input is triggered. That means that the "Text for on" is entered in the panel in the list of monitoring functions. If an input fails, the "Text for failure" is entered in the list of faults. Both the "Text for on" and the "Text for off" can be freely set for each input.

The monitoring function has two communication objects "Releasing inputs" and "Failure inputs" which can send out the input states. The two objects can adopt 1-byte or 14-byte values. This is dependent on the setting "Type of output".

In the case of a 1-byte output variable, when an input is triggered in the armed state, the number of the input which has been triggered is sent to the 1-byte object "Releasing inputs". If an input fails, the number of the input which has failed is sent to the 1-byte object "Failure inputs".

If the "Type of output" is set to 14 bytes, the "Message text at releasing" of the respective input is sent to the 14-byte object "Releasing inputs" when an input is triggered. In the event of a fault, the 14-byte object "Failure inputs" sends the "Message text at failure" of the input. Both text elements can be freely assigned to each input and contain up to 13 characters.

The transmitted 14-byte text can open a pop-up window on the display with the help of the alarm functionality, which immediately displays a visual and/or acoustic fault or a trigger. The user does not therefore need to first change to the list of alarm and fault messages but sees directly that there is a problem with the installation.

If at least one input has a fault, the installation can be armed directly. The input or inputs must first be acknowledged in order to arm the system. The faulty inputs are removed from the monitoring as a result. The acknowledgement can either be carried out directly on the panel or via the 1-bit communication object "Failure reset inputs".

Example:

The installation should be armed externally at an entrance door with the help of a key-operated switch. The movement detector in the cellar is however currently faulty i.e. it no longer sends a cyclical telegram and is thus faulty. So that the user can still arm his system, he must first acknowledge the faulty input. This can e.g. be carried out via a 1-fold switch sensor.

Note:

Using this function, it is possible to arm the installation even if an input is faulty. The input is temporarily removed from the monitored installation through the acknowledgement.

If the parameter "Delete failure message at external display" is set to "yes", a so-called zero string is sent to the object "Failure inputs" in the event of a fault acknowledgement. This means that a telegram is sent whose useful information consists of bits with the value "0". Display text on an external display is thus reset.

Arming (Monitoring function)

The installation can be armed internally or externally. Internally means entering a four-digit PIN code directly on the panel. This is defined via the setting "Code for arming/disarming". The code can however also be modified by the user. To do so, the old code must be entered once and the new code must be entered twice.

Note:

Please note the setting "Overwrite code at download". If "yes" is selected, the code which has been modified by the user is overwritten with the original code after each reconfiguration of the panel.

The system can be armed externally via a maximum of three 1-bit communication objects "Arming ...". Each object can be controlled via a separate group address. This is necessary if the system should be armed from several entry doors. It is defined via "Number of entry doors" whether one, two or three arming objects are displayed.

The "Type of arming/disarming" is only for information, in a similar way to the inputs. The setting has no influence on the behaviour of the panel.

When the system is armed, all the input objects must send the value "0" cyclically i.e. all the windows must be closed and the movement detectors cannot report any movement. If the input should not send any "0" values cyclically due to a fault, the panel can be acknowledged directly via the panel or via

the object "Failure reset inputs" of the input i.e. removed from the monitoring. It is then possible to arm the system.

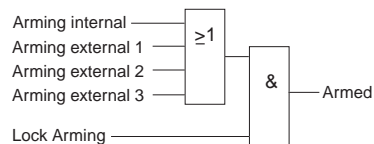

The system can be armed via the first "Arming" object, the second object or the third. The inputs are linked with an OR function. In addition, an "Activate arming" object is enabled via a corresponding parameter. If the object is visible, arming is enabled with an ON telegram. An OFF telegram disables the possibility of arming the system.

Once the panel has been armed, a delay period elapses until the panel is actually triggered by an input signal. The period is set via "Time delay at arming". If e.g. the panel is located in the entrance area of a house, the user must still be given the opportunity to leave the house before the system is armed. If this delay did not exist, in many cases an alarm would always be triggered immediately after arming the system.

Armed status (Monitoring function)

It is indicated via two 1-bit communication objects that the system is in the armed state. The object "Armed status" sends an ON telegram as soon as the system is armed (once the "Time delay at arming" has elapsed). If the system is disarmed, the object sends an OFF telegram. It would therefore be possible e.g. for an LED of a switch sensor which is mounted at an entrance door to be switched.

The second object "Armed status flashing" must first be enabled via the corresponding parameter. A telegram sequence is then sent via this object once the system is armed so that e.g. an external lamp flashes three times. The user who has armed his house via a key bolt contact is therefore informed before he reaches his house that the system is now set. Depending on the status of the actuator, six telegrams are sent with the following useful information:

1 - 0 - 1 - 0 - 1 - 0 or
0 - 1 - 0 - 1 - 0 - 1

Alarm (Monitoring function)

If an ON telegram is received at an input in the armed state, the panel triggers an alarm. There are four different alarm messages (objects).

Internal alarm:

The internal alarm is triggered immediately and without a delay. An ON telegram is sent to the 1-bit communication object "Internal alarm". This could trigger an additional horn in the house or be linked with the alarm function of the panel itself. In the latter case, a message and if necessary a signal tone is displayed/triggered at the panel itself.

Alarm

The alarm is a continuous alarm and is sent via the 1-bit communication object "Alarm" with a time delay. The "Time delay as long as alarm release" can be set. A warning lamp for example could be addressed via this object.

Example:

A system has been armed directly on the panel in the hallway. The user comes home and automatically triggers an internal alarm. He now has the "Time delay as long as alarm release" to prevent an acoustic signal e.g. an outdoor siren.

Alarm impulse

The 1-bit object "Alarm impulse" is used to address a horn in front of the house. In the event of an alarm, this may only be triggered for maximum 3 min (legal regulation). This means that an ON telegram is sent to the object once the "Time delay as long as alarm release" has elapsed. The period "Time of the external audio signal" now starts. If this has elapsed, an OFF telegram is sent. The "Time of the external audio signal" can be set to 1 min, 2 min or 3 min.

Silent alarm

The silent alarm is retrieved by entering the PIN code for the silent alarm.

Example:

An intruder has entered the house in the night and forces the owner to cancel the alarm. Normally, the owner would enter the PIN code to deactivate the system and the system would be disarmed. If he however en-

ters the PIN code for the silent alarm, the objects "Alarm", "Internal alarm" and "Alarm impulse" are reset but the 1-bit communication object "Silent alarm" sends an ON telegram. A telephone dialling device or similar could be addressed via this object.

The PIN code for the silent alarm is defined in the panel software in a similar way to the PIN code for arming/disarming the system. The user can modify the PIN code, whereby he presses the touch surface that is assigned the monitoring function and retrieves the function "Code for silent alarm" in the subsequent window (only visible in the disarmed state).

Input failure if armed (Monitoring function)

If an input failure occurs while the system is armed, this does not trigger an alarm. To inform the user about this input failure, there is the 1-bit communication object "Inputs failure if armed". In the event of faults, an ON telegram is sent via this object.

Installation status (Monitoring function)

The new status is sent via the object "Installation status" as soon as the status of the panel changes. The object is 1 byte or 14 bytes depending on the setting "Type of output". The system knows three different states:

- Unset
- Ready to set
- Set

The following table indicates which values are sent for the different bit sizes:

State	1 byte	14 byte
Set	0	Unset
Ready to set	1	Ready to set
Set	2	Set

Example: Detached house

BM1 and BM2:
 Movement detectors

MK1 to MK6:
 Magnetic contacts

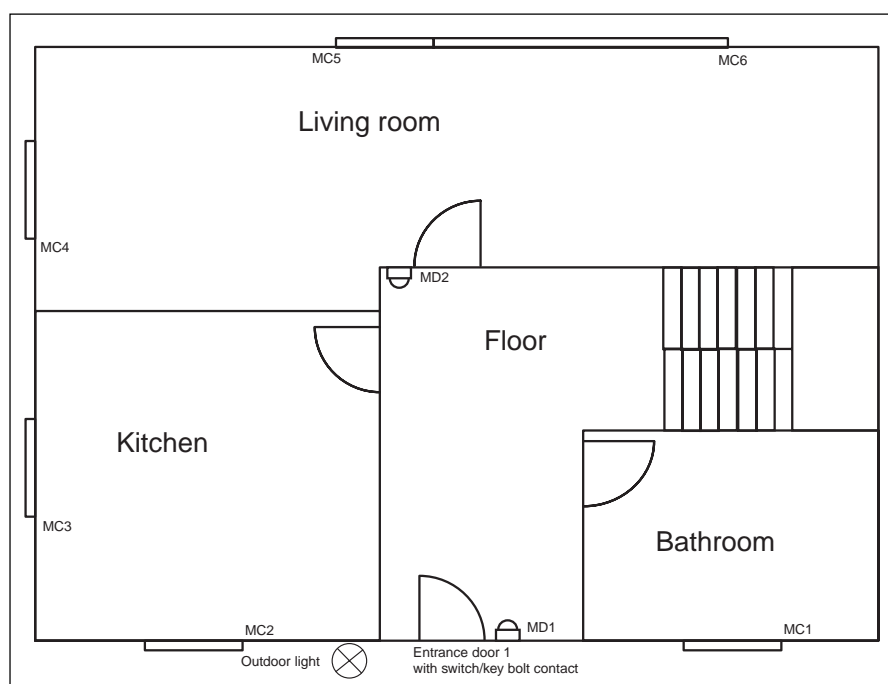

The diagram above shows an application example for the monitoring function of the SMARTtouch panel.

The states of the magnetic contacts MC1 to MC6 and the switch/key bolt contact of the entrance door are recorded with binary inputs or universal interfaces and sent on the EIB. The detectors MD1 and MD2 are EIB movement detectors and send their signals immediately on the bus.

The magnetic contacts and the movement detectors are linked via group addresses/actions with the inputs of the panel. The switch/key bolt contact with a group address is assigned to an arming object.

When the user leaves the house, he arms the system by locking up. If the external light is also controlled via EIB, it can signal via the object "Armed status flashing" that the system is now armed. If the user does not receive a flashing status, he knows that there is a problem with the installation. A window is still open perhaps.

ABB i-bus® EIB
ABB Powernet EIB

LEANtouch (monochrome),
SMARTtouch (monochrome, colour)
Type: 6x36/30M(-500), 6x36/100x(-500), 6x36/100CB

**Functional description: Touch
surfaces (Homepage)**

Function	Application
Headline Homepage	Settings
Button 1 (Homepage)	Control function Monitoring function Inactive
Button 2 (Homepage)	Control function Inactive
Button 3 (Homepage)	Control function Inactive
Button 4 (Homepage)	Control function Inactive
Button 5 (Homepage)	Control function Inactive
Button 6 (Homepage)	Control function Inactive
Button 7 (Homepage)	Control function Inactive
Button 8 (Homepage)	Control function Inactive
Button 9 (Homepage)	Control function Inactive
Button 10 (Homepage)	Control function Inactive

Communication objects
 for monitoring function

No.	Type	Object name	Function
0	1 bit	Arming 1	Receive
1	1 bit	Arming 2	Receive
2	1 bit	Arming 3	Receive
3	1 bit	Activate arming	Receive
4	1 bit	Alarm	Send
5	1 bit	Internal alarm	Send
6	1 bit	Silent alarm	Send
7	1 bit	Alarm impulse	Send
8	1 bit	Armed status	Send
9	1 bit	Armed status flashing	Send
10	1 byte	Releasing inputs	Send
11	1 byte	Failure inputs	Send
12	1 bit	Failure reset inputs	Receive
13	1 bit	Inputs failure if armed	Send
14	1 byte	Installation status	Send
15	1 bit	Entry 1 (Input 1)	Receive
16	1 bit	Entry 2 (Input 2)	Receive
17	1 bit	Entry 3 (Input 3)	Receive
18	1 bit	Entry 4 (Input 4)	Receive
19	1 bit	Entry 5 (Input 5)	Receive
20	1 bit	Entry 6 (Input 6)	Receive
21	1 bit	Entry 7 (Input 7)	Receive
22	1 bit	Entry 8 (Input 8)	Receive
23	1 bit	Entry 9 (Input 9)	Receive
24	1 bit	Entry 10 (Input 10)	Receive
25	1 bit	Entry 11 (Input 11)	Receive
26	1 bit	Entry 12 (Input 12)	Receive
27	1 bit	Entry 13 (Input 13)	Receive
28	1 bit	Entry 14 (Input 14)	Receive
29	1 bit	Entry 15 (Input 15)	Receive
30	1 bit	Entry 16 (Input 16)	Receive

No.	Type	Object name	Function
...			
10	14 byte	Releasing inputs	Send
11	14 byte	Failure inputs	Send
...			
14	14 byte	Installation status	Send
...			

Parameters: Headline Homepage
The default setting for the values is **printed in bold type**.

– Headline Homepage <Text>

Control function parameter
The default setting for the values is **printed in bold type**.

– Name of touch surface (Homepage) <Text>

Monitoring function parameters
The default setting for the values is **printed in bold type**.

– Name of touch surface <Text>

General:

– Code for arming/disarming (0000...9999) **0000**

– Code for silent alarm (0000...9999) **0000**

– Overwrite code at download **No / Yes**

– Number of entry doors
None (internal monitoring)
1
2
3

– Type of arming/disarming **Internal lock/PIN code/ push button**
Block lock
External lock/PIN code/ transponder
Bolt switch contact

– Monitoring time of inputs 1 min / 3 min / 5 min / **10 min** / 20 min / 30 min

– Number of inputs (1...16) **8**

– Monitoring of inputs after mains voltage recovery 20 s / 30 s / **1 min** / 5 min / 10 min

– Time delay at arming None / 10 s / 15 s / **20 s** / 25 s / 30 s / 35 s / 40 s / 1 min

– Time delay as long as alarm release None / 10 s / 15 s / **20 s** / 25 s / 30 s / 35 s / 40 s / 1 min

– Time of the external audio signal **1 min** / 2 min / 3 min

– Activate arming via object **No / Yes**

– Armed status flashing **No / Yes**

– Delete failure message at external display **No / Yes**

– Type of output 1 Byte / **14 Byte**

Input parameters
The default setting for the values is **printed in bold type**.

Separate for each input:

– Type of input ... **Window**
Watch dog sensor
Watch dog sensor in the entry area
Door (not in the entry area)
Entry door 1
Entry door 2
Entry door 3

– Description of the input <Text>

– Text for on <Text>

– Text for failure <Text>

– Message text at releasing (max. 13 characters) <Text>

– Message text at failure (max. 13 characters) <Text>

Functional description: Touch surfaces (Control page)

Each touch surface can adopt various functions. Depending on the set function, the panel software displays different communication objects and parameters.



The "Name of touch surface" is always on the left-hand side of the touch surface. This can be freely assigned to each touch surface with the corresponding parameter.

The status display is on the right-hand side of the touch surface. This can either be a symbol or text.



If this button is "Active", a window opens when the touch surface is operated. The "Name of touch surface" appears in the window as a heading. The buttons (designated here with "ON" and "OFF") can be described with text or adopt symbols.

As soon as a touch surface is operated, the panel sends a corresponding telegram to the linked communication object. In some windows, a slide rule appears in addition to the buttons. If the button on the slide rule is set to a new position, the linked object also sends the new value automatically.

If the status display or the button description should adopt a symbol, it can be selected from a pull-down menu. The panel software always indicates all the context-related symbols. (See also the parameter listings of the individual functions)

Switch

If the function of the touch surface is defined as "Switch", the panel sends ON or OFF telegrams via the associated 1-bit object "Switch".

In the default setting, the touch surface sends OFF telegrams when the right-hand side is pressed and sends ON telegrams when the left-hand side is pressed. The method of operation of the touch surface can be inverted via the parameter "Behaviour".

Push button

In the "Push button" function, there is a 1-bit communication object "Switch" available for defined switching. ON, OFF or TOGGLE telegrams can be sent on the EIB via this object.

Each pulse edge can therefore be set individually. This means: if the touch surface is pressed, this is evaluated by the panel as a rising pulse edge while the release of the touch surface is evaluated as a falling pulse edge.

The touch surface can thus be adapted to a wide variety of applications. If e.g. inching mode should be implemented, the setting "Send on at rising edge, off at falling edge" should be selected.

Dimmer

With the "Dimmer" function, an ON or OFF command is sent to the 1-bit communication object "Switch" after a short operation of the corresponding touch surface. If the surface is operated for a longer period, the panel sends commands for dimming brighter or darker to the 4-bit object "Dim". If the touch surface is released after a long operation, the panel immediately sends the command "Stop dimming".

The behaviour of the buttons can be set. This means it is possible to dim brighter or darker via the left or right button (switch on, off or toggle).

The status display of the button can also display the direct value (0%...100% or 0...255) as an alternative to the text or symbol display. To do so, the 1-byte object of the touch surface must first be linked with that of the dimming actuator.

Shutter

In the "Shutter" function, the touch surface has two 1-bit communication objects "Move" and "Step". After a long operation, the panel sends telegrams to the linked shutter actuators to raise or lower the shutters. After a short operation, it sends telegrams to stop shutter movement or for louvre adjustment.

With the setting "Behaviour", it is defined whether the shutter moves upwards or downwards when the right or the left touch surface is pressed.

Lightscenes external input (1 bit)

In the function "Lightscenes external input (1 bit)", the touch surface has a 1-bit communication object. Two lightscenes can be sent via this object. On each operation of the pulse edge, the active lightscene changes (from 0 to 1, from 1 to 0).

Lightscenes external input (1 byte)

With the function "Lightscenes external input (1 byte)", one of 32 lightscenes can be sent via a 1-byte communication object. The setting "Lightscene number" defines which lightscene is sent.

The user has the option of storing lightscenes himself. To do so, the parameter "Store scene by long push" must be set to "possible". After a long operation of the touch surface (> 3 s), a bit is additionally set to "1" in the 1-byte lightscene telegram. A lightscene module (generally the LEANtouch/SMARTtouch panel) therefore knows that the requested lightscene should be stored and not retrieved. (See also "Functional description: Lightscenes")

Value (1 byte, 2 byte)

The "Value" function causes the touch surface to send value telegrams via the associated "Value" object. Depending on whether the function "Value (1 byte)"

or "Value (2 byte)" has been selected, the communication object is 1 byte or 2 bytes in size.

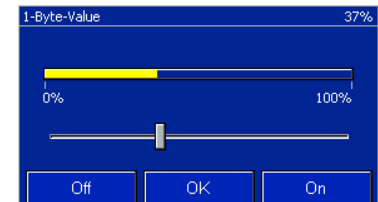

The 1-byte value function can display or send the following physical variables:

- Brightness
- Wetness (show only)
- Volume
- Value
- Temperature offset
- Current (show only)

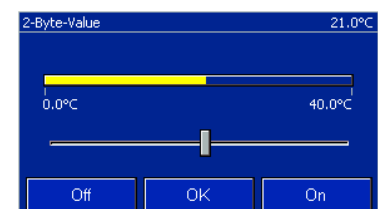

The 2-byte value function has the following variables by default:

- Temperature
- Illumination
- Wind force

The respective physical variables are defined via the parameter "Display type". There is also the possibility of setting the "Display type" to "free scalable" for both values (1 byte and 2 byte). Other values than the preset values can thus also be displayed.

With the freely scalable setting, it is possible to parameterise the number of decimal places, the minimum and maximum object value and the minimum and maximum display value.

If the touch surface is pressed ("show and send"), the panel indicates a slide rule in the open window. The individual values can be set via this slide. A display in the upper section of the window indicates the exact value. The value is adjusted upwards or downwards by the smallest possible unit via the fields "On" or "Off".

Room thermostat

If the function of the touch surface is defined as “Room thermostat”, the touch surface is used to control a room thermostat in order to change operating mode in the thermostat.

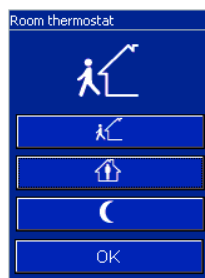

As the room thermostat touch surface is an active button, a window with three further buttons “Comfort”, “Night” and “Frost” opens when it is operated. Each of these three buttons has a 1-bit communication object. The objects “Comfort/Standby”, “Night” and “Frost/heat protection” are each linked via a group address with the similarly named objects of a room thermostat.

The linked room thermostat can be the internal thermostat of the panel or an external device (e.g. Busch-triton® RT).

Floating point value

With the “Floating value” function, a touch surface can display and/or send a value of -99,999 to +99,999. There is a 4-byte communication object “Floating point value” available for this function.

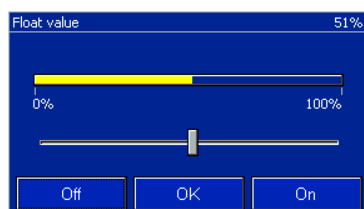

If the “Floating value” touch surface is pressed, the panel displays a slide rule and three buttons in the open window. Values can be set intuitively via the slide rule by adjusting the control button. Depending on the setting, the value can be increased or decreased via the buttons. As soon as the slide rule is released or a button has been pressed, a new telegram

with the new floating point value is triggered.

The displayed or transmitted values can adopt up to three decimal places, depending on the setting. The default setting is a percentage value (0...100%).

The object value and the display value can be set separately in the parameters. The object value is the value which is sent via the 4-byte object “Floating point value”. The maximum or minimum object as well as the smallest or largest display value can be set individually (from -99,999 to +99,999). It is therefore possible to display a larger value and to simultaneously limit the transmitted value to a smaller range.

Counter

If a touch surface is assigned the function “Counter”, it is used to indicate counter contents. These can be counts with and without leading signs. It depends on the setting “Display type” as to whether the display has a leading sign.

Three different bit sizes can be displayed. It is defined directly via the functional selection whether a 1-byte, 2-byte or a 4-byte count should be displayed. Depending on the selection, a 1-byte, 2-byte or a 4-byte communication object “Counter value” is available for receiving new count values.

Text

The “Text” function enables a 14-byte long text element to be displayed on the touch surface or sent. The function has a 14-byte communication object “Text” for receiving and sending text.

It is defined via the “Text” setting in the parameters whether the text should only be displayed or displayed and sent. If text should also be sent, the text is defined in the field “Message text”. The text may be 13 characters long.

Functional description: Touch surfaces (Control page)

Function	Application
Button 1 (Control page)	Inactive Switch Push button Dimmer Shutter Lightscenescenes external input (1 Bit) Lightscenescenes external input (1 Byte) Value (1 Byte) Value (2 Byte) Room thermostat Floating value (4 Byte) Counter (2 Byte) Counter (4 Byte) Counter (1 Byte) Text
Button 2 (Control page)	Inactive Switch Push button Dimmer Shutter Lightscenescenes external input (1 Bit) Lightscenescenes external input (1 Byte) Value (1 Byte) Value (2 Byte) Room thermostat Floating value (4 Byte) Counter (2 Byte) Counter (4 Byte) Counter (1 Byte) Text
...	
Button 10 (Control page)	Inactive Switch Push button Dimmer Shutter Lightscenescenes external input (1 Bit) Lightscenescenes external input (1 Byte) Value (1 Byte) Value (2 Byte) Room thermostat Floating value (4 Byte) Counter (2 Byte) Counter (4 Byte) Counter (1 Byte) Text

Communication objects
for "Switch" touch surfaces (Control page)

No.	Type	Object name	Function
0	1 bit	Switch	Send/Receive

Communication objects
for "Push button" touch surfaces (Control page)

No.	Type	Object name	Function
0	1 bit	Switch	Send/Receive

Communication objects
for "Dimmer" touch surfaces (Control page)

No.	Type	Object name	Function
0	1 bit	Switch	Send/Receive
1	4 bit	Dim	Send
2	1 byte	Value	Receive

Communication objects
for "Shutter" touch surfaces (Control page)

No.	Type	Object name	Function
0	1 bit	Move	Send/Receive
1	1 bit	Step	Send

Communication objects
for "1-bit lightscenes" touch surfaces (Control page)

No.	Type	Object name	Function
0	1 bit	Lightscene number	Send/Receive

Communication objects
for "1-byte lightscenes" touch surfaces (Control page)

No.	Type	Object name	Function
0	1 byte	Lightscene number	Send/Receive

Communication objects
for "1-byte value" touch surfaces (Control page)

No.	Type	Object name	Function
0	1 byte	Value	Send/Receive

Communication objects
for "2 byte value" touch surfaces (Control page)

No.	Type	Object name	Function
0	2 byte	Value	Send/Receive

Communication objects
for "Room thermostat" touch surfaces (Control page)

No.	Type	Object name	Function
0	1 bit	Standby/Comfort	Send/Receive
1	1 bit	Night	Send/Receive
2	1 bit	Frost/heat protection	Send/Receive

Communication objects
for "Floating value" touch surfaces (Control page)

No.	Type	Object name	Function
0	4 byte	Floating point value	Send/Receive

Communication objects
for "2-byte counter" touch surfaces (Control page)

No.	Type	Object name	Function
0	2 byte	Counter value	Receive

Communication objects
for "4-byte counter" touch surfaces (Control page)

No.	Type	Object name	Function
0	4 byte	Counter value	Receive

Communication objects
for "1-byte counter" touch surfaces (Control page)

No.	Type	Object name	Function
0	1 byte	Counter value	Receive

Communication objects
for "Text" touch surfaces (Control page)

No.	Type	Object name	Function
0	14 byte	Text	Send/Receive

Parameters: “Switch” touch surface
The default setting for the values is **printed in bold type**.

– Name of the button	<Text>
– Button	Inactive Active
Only if “Active” is selected:	
– Behaviour	Left=Off, Right=On Left=On, Right=Off
– Status display	Text Symbol
Only if “Text” is selected:	
– Text for on	On
– Text for off	Off
Only if “Symbol” is selected:	(see below)
– Button description	Text Symbol
Only if “Text” is selected:	
– Text for on	On
– Text for off	Off
Only if “Symbol” is selected:	(see below)

Parameters: “Push button” touch surface
The default setting for the values is **printed in bold type**.

– Name of touch surface (Control page)	<Text>
– Button	Inactive Active
Only if “Active” is selected:	
– Behaviour	Send off at rising flank Send off at falling flank Send off at both flanks Send on at falling flank Send off at rising flank, on at falling flank Send on at rising flank Send on at rising flank, off at falling flank Send on at both flanks Toggle at rising flank
– Display switching status	Text Symbol
Only if “Text” is selected:	
– Text for 1	On
– Text for 0	Off
Only if “Symbol” is selected:	(see below)
– Button description	Text
Only if “Text” is selected:	
– Button text	Push button

Symbols for “Switch” or “Push button” touch surface

Symbols for status display ON/OFF:

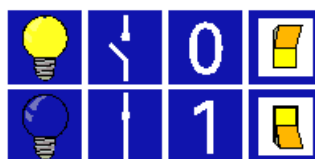

Symbols for button description ON/OFF:

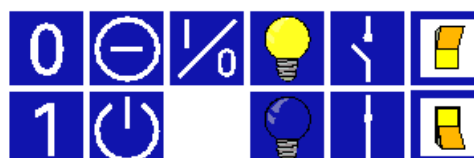

Parameters: “Dimmer” touch surface
 The default setting for the values is **printed in bold type**.

– Name of touch surface	<Text>
– Button	Inactive Active
Only if “Active” is selected:	
– Behaviour	Left brighter on, right darker off Left darker off, right brighter on Left brighter toggle, right darker toggle Left darker toggle, right brighter toggle
– Button description	Text Symbol
Only if “Text” is selected:	
– Text for ON resp. brighter	On
– Text for OFF resp. darker	Off
Only if “Symbol” is selected:	(see below)
– Display switching status	Text Symbol Direct value display (0%...100%) Direct value display (0...255)
Only if “Text” is selected:	
– Text for ON resp. brighter	On
– Text for OFF resp. darker	Off
Only if “Symbol” is selected:	(see below)

Symbols for button description ON/OFF or brighter/darker:

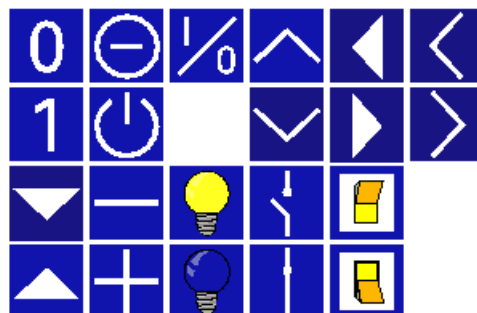

Symbols for status display ON/OFF or brighter/darker:

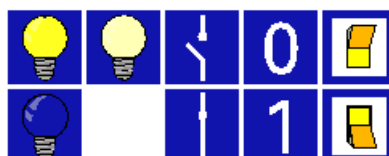

Parameters: "Shutter" touch surface
 The default setting for the values
 is **printed in bold type**.

- Name of touch surface (Control page)	<Text>
- Behaviour	Left=up/right=down Left=down/right=up
- Button description	Text Symbol
Only if "Text" is selected:	
- Text for 1 resp. down	Down
- Text for 0 resp. up	Up
Only if "Symbol" is selected: (see below)	
- Display switching status	Text Symbol
Only if "Text" is selected:	
- Text for 1 resp. down	Down
- Text for 0 resp. up	Up
Only if "Symbol" is selected: (see below)	

Symbols for button description 1-0 or UP/DOWN:

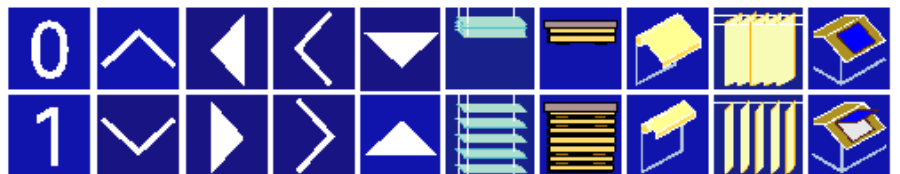

Symbols for status display 1-0 or UP/DOWN:



**Parameters: “1-bit lightscenes”
 touch surface**

The default setting for the values is **printed in bold type**.

– Name of touch surface (Control page)	<Text>
– Lightscene number	0 / 1
– Store scene by long push	not possible
– Button description	Text Symbol
Only if “Text” is selected:	
– Text for lightscene call	Start
Only if “Symbol” is selected:	<i>(see below)</i>
– Display switching status	Text Symbol
Only if “Text” is selected:	
– Text if scene is active	Active
Only if “Symbol” is selected:	<i>(see below)</i>

Symbols for button description “Lightscene retrieval”:

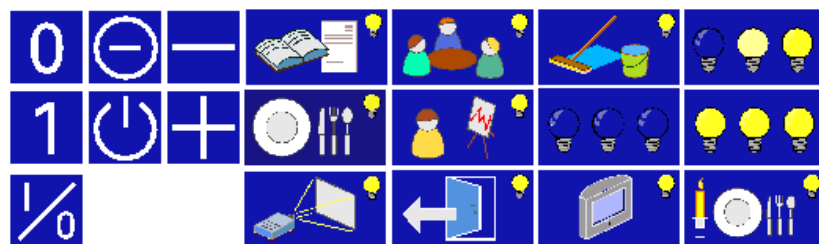

Symbols for status display if scene is active:

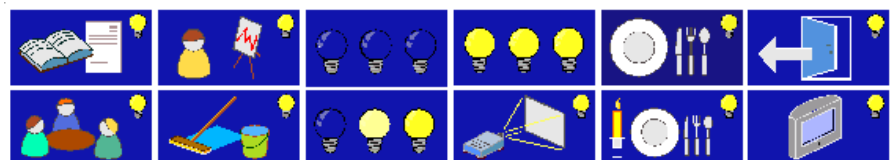

Parameters: “1-byte value” touch surface

The default setting for the values is printed in bold type.

– Name of touch surface (Control page)	<Text>
– Display type	Brightness Wetness Volume Value Temperature offset (-5K...+5K) Current free scalable
Only for brightness, volume and value:	
– Value	show only show and send
– Range of values	0% to 100% 0 to 255
Only for “show and send”:	
– Button description	Text Symbol
Only if “Text” is selected:	
– Text for value increasing	On
– Text for value lowering	Off
Only if “Symbol” is selected:	(see below)
Only for wetness:	
– Value	show only
– Range of values	0% to 100% 0 to 255
Only for temperature offset:	
– Value	show and send
– Range of values	-5K to +5K
– Button description	Text Symbol
Only if “Text” is selected:	
– Text for value increasing	On
– Text for value lowering	Off
Only if “Symbol” is selected:	(see below)
Only for current:	
– Value	show only
– Range of values	0 to 51.5 mA 0 to 25.5 A
Only for “free scalable”:	
– Unit	%
– Decimal places	0 / 1 / 2
– Minimum object value	0
– Maximum object value	255
– Lowest display value	0
– Highest display value	255
– Value	show only show and send
Only for “show and send”:	
– Button description	Text Symbol
Only if “Text” is selected:	
– Text for value increasing	On
– Text for value lowering	Off
Only if “Symbol” is selected:	(see below)

Symbols for button description:



Parameters: “2-byte value” touch surface

The default setting for the values is **printed in bold type**.

- Name of touch surface (Control page)	<Text>
- Display type	Temperature Illumination Wind force free scalable
Only for temperature:	
- Range of values	-0.0°C ... 40.0°C -99.9°C ... 600.0°C -5K ... +5K
Only for -0.0°C...40.0°C:	
- Increment	0.25°C / 0.5°C / 1°C / 2°C
Only for -99.9°C...600.0°C:	
- Increment	3°C / 5°C / 10°C / 20°C
Only for -5K...+5K:	
- Increment	0.1K / 0.2K / 0.5K / 1K
- Value	show only show and send
- Button description	Text Symbol
Only if “Text” is selected:	
- Text for value increasing	On
- Text for value lowering	Off
Only if “Symbol” is selected:	(see below)
Only for illumination:	
- Range of values	0...100,000 lux
Only for wind force:	
- Range of values	0...200 m/s
Only for “free scalable”:	
- Unit	%
- Decimal places	0 / 1 / 2 / 3
- Minimum object value	0
- Maximum object value	100
- Lowest display value	0
- Highest display value	100
- Button description	Text Symbol
Only if “Text” is selected:	
- Text for value increasing	On
- Text for value lowering	Off
Only if “Symbol” is selected:	(see below)

Symbols for button description:



**Parameters: “Room thermostat”
touch surface**
The default setting for the values
is **printed in bold type**.

– Name of touch surface (Control page)	<Text>
– Button	Inactive Active
– Button description	Text Symbol
Only if “Text” is selected:	
– Text for comfort	Comfort
– Text for standby	Standby
– Text for night reduction	Night
Only if “Symbol” is selected:	(see below)

Symbols for button description:



Parameters: “Floating value” touch surface

The default setting for the values is **printed in bold type**.

- Name of touch surface (Control page)	<Text>
- Unit	%
- Decimal places	0 / 1 / 2 / 3
- Minimum object value	0
- Maximum object value	100
- Lowest display value	0
- Highest display value	100
- Value	show only show a
Only for “show and send”:	
- Button description	Text Symbol
Only if “Text” is selected:	
- Text for value increasing	On
- Text for value lowering	Off
Only if “Symbol” is selected: (see below)	

Symbols for button description:



Parameters: “2-byte counter” touch surface

The default setting for the values is **printed in bold type**.

– Name of touch surface (Control page)	<Text>
– Display type	without leading sign with leading sign

Parameters: “4-byte counter” touch surface

The default setting for the values is **printed in bold type**.

– Name of touch surface (Control page)	<Text>
– Display type	without leading sign with leading sign

Parameters: “1-byte counter” touch surface

The default setting for the values is **printed in bold type**.

– Name of touch surface (Control page)	<Text>
– Display type	without leading sign with leading sign

Parameters: “Text” touch surface

The default setting for the values is **printed in bold type**.

– Name of touch surface (Control page)	<Text>
– Text	show only show and send
Only for “show and send”:	
– Message text (max. 13 characters)	Text

Functional description: Time programs

Settings

Depending on the parameterisation, the SMARTtouch panel offers up to 20 (5 for LEANtouch) switch channels. The number of channels that should be enabled is defined in the general settings.

In addition, there is the possibility of "Enable time programs for end customers" via the corresponding parameter. The modification option can be given a code or fully disabled.

Changes made by the end customer are stored in the memory of the panel and are not lost on mains voltage failure. If however changes are made to the rest of the panel configuration and then programmed into the panel, the panel software overwrites by default the time settings of the end customer. This behaviour can be modified via the setting "Overwrite time switch settings at download".

A so-called astro function can also be activated for the individual switching times. This means that a set switching time adapts itself to sunrises and sunsets. With the option "Town selection", it is possible to select a town in Germany which is closest to the installation site of the panel. If the exact coordinates are known, the longitude and latitude can also be entered.

Holiday

The LEANtouch/SMARTtouch panel has the option of setting each individual channel to a so-called holiday function. The setting "active on holidays" can be selected for each switching time on the switch channel.

Under the menu item "Extra" on the panel, you can find the "Holiday" touch surface which you use to activate the holiday function. Two further buttons "Start of holiday" and "End of holiday" are activated which you can use to enter the required date. If the date for the "Start of holiday" is reached, all the corresponding holiday time programs are activated automatically.

Individual time programs can thus be retrieved in the holiday period (holiday profile). When the date for the "End of holiday" is reached, the holiday time programs are automatically deactivated.

The holiday function is activated via the 1-bit communication object "Holiday". An ON telegram switches the function on while an OFF telegram switches it off again. The linking of the object "Holiday" with an internal address of the panel can of course also be carried out.

Note:

Please note that only those switch channels which you have explicitly selected via the parameter "Switching function" switch on and off in the holiday function. This is carried out separately for each switching time on the channel.

Switch channels

Each switch channel has at least one 1-bit or 1-byte communication object. It is therefore possible for switch, shutter and/or dimming actuators to be addressed. The bit size is determined via the setting "Function".

Alternatively, it can also be determined via the "Function" parameter whether a room thermostat should be addressed via a switch channel. In this case, the switch channel has two 1-bit objects "Standby/Comfort" and "Night". It is thereby possible to directly toggle the "Comfort" and "Night" communication objects of the room thermostat. These can either be internal objects of the panel which are linked via an internal group address or an external room thermostat. In the latter case, the objects must be linked with a corresponding group address.

An additional 1-bit enable object can be activated on each switch channel. This is carried out via the parameter "Activation object". If an enable object is activated, this must receive an ON telegram so that the time switch channel is able to switch.

The switch channels of the SMARTtouch panel have 10 (5 for LEANtouch) switching times each. The switching times can either be set on the panel (see diagram) or in the parameters of the panel software.

It can be defined on which day of the week and at which switching time the channel should be switched.

Diagram for setting the switching times directly on the panel, if this option is enabled

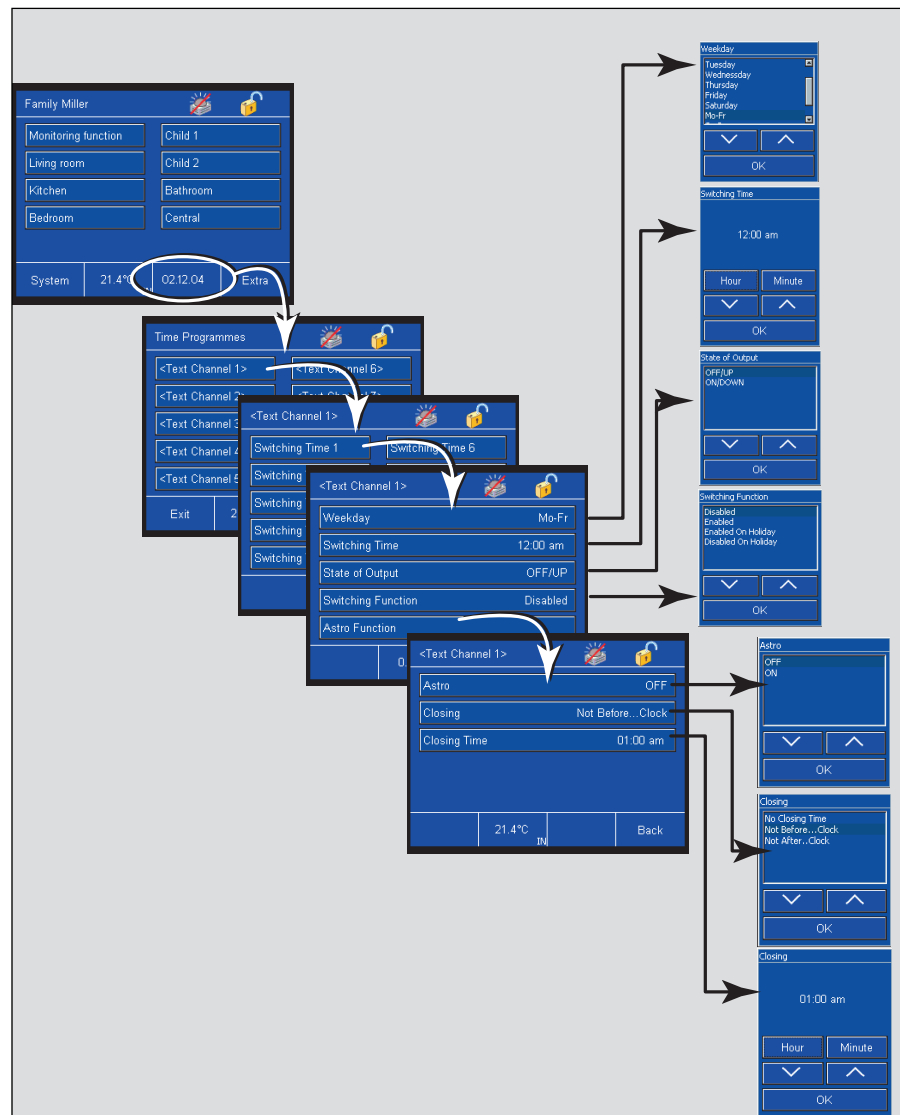

If a 1-bit function is set, it is possible to switch either OFF/UP or ON/DOWN. If a 1-byte function is set, a value between 0 and 255 or a percentage value of 0% to 100% can be sent. The room thermostat function makes it possible to change to the comfort, standby or night operating mode of the room thermostat.

In addition, there is the possibility of integrating each channel in the holiday functionality (see also "Holiday")

In addition, the astro functionality can be activated for each channel. Blocking times can also be set such as "not before 05:00" or "not after 22:00". The automatic adjustment of the astro programs are restricted due to the position of the sun which changes daily. For example, a shutter would never be lowered later than 22:00, even if a further connection would be necessary according to the ASTRO calendar.

Functional description: Time programs

Function	Application
General	Settings
Switch channel 1	Switch
Switch channel 2	Switch
Switch channel 3	Switch
Switch channel 4	Switch
Switch channel 5	Switch
Switch channel 6	Switch
Switch channel 7	Switch
Switch channel 8	Switch
Switch channel 9	Switch
Switch channel 10	Switch
Switch channel 11	Switch
Switch channel 12	Switch
Switch channel 13	Switch
Switch channel 14	Switch
Switch channel 15	Switch
Switch channel 16	Switch
Switch channel 17	Switch
Switch channel 18	Switch
Switch channel 19	Switch
Switch channel 20	Switch

Communication objects
 for time programs (General)

No.	Type	Object name	Function
0	1 bit	Holiday	Receive

Communication objects
 for "Switch" switch channel

No.	Type	Object name	Function
0	1 bit	Switch	Send
2	1 bit	Enable	Send/Receive

Communication objects
 for "Value" switch channel

No.	Type	Object name	Function
0	1 byte	Value	Send
2	1 bit	Enable	Send/Receive

Communication objects
 for RT switch channel

No.	Type	Object name	Function
0	1 bit	Standby/Comfort	Send
1	1 bit	Night	Send
2	1 bit	Enable	Send/Receive

Parameters: General settings
 The default setting for the values
 is **printed in bold type**.

General	
- Number of switch channels 1...20 (LEANtouch (1...5))	1 / 2 / 3 / 4 / ... / 19 / 20
- Overwrite time switch settings at download	No / Yes
- Enable time programs for end customers	Yes With code No
- Coordinates for astro displacement	via town selection via input of coordinates
Only for town selection:	
- Town	Berlin Bielefeld Bremen Essen Flensburg Frankfurt Hamburg Hannover Kassel Köln Mönchengladbach München Nürnberg Saarbrücken Stuttgart Dresden
Only for coordinates:	
- Latitude	51.216
- Longitude	7.633

**General parameters for switch
 channels (separate for each switch
 channel)**
 The default setting for the values
 is **printed in bold type**.

General	
- Name of time channel	<Text>
- Function	1 Bit 1 Byte (0...255) 1 Byte (0...100%) RT (Standby/Comfort Night)
- Activation object	No / Yes
Only for "Yes":	
- Activation object after mains voltage recovery	Disabled Enabled

**Parameters for switching times
 (separate for each switching time)**
 The default setting for the values
 is **printed in bold type**.

- Time	00:00
- Weekday	Monday Tuesday Wednesday Thursday Friday Saturday Sunday Monday to Friday Monday to Saturday Monday to Sunday Saturday and Sunday
Only for 1-bit function:	
- Status	Off/Up On/Down
Only for 1-byte function (0...255)	
- Status	0
Only for 1-byte function (0...100%):	
- Status	0% / 10% / 20% / ... / 90% / 100%
Only for RT function:	
- Status	Standby Comfort Night
- Astro	Inactive Active
- Locking	Inactive not before ... o'clock not after ... o'clock
- Blocking time	00:00
- Switching function	always inactive always active active on holidays inactive on holidays

Functional description: IR control

General

The LEANTouch/SMARTTouch panel can be addressed via IR remote control. All the panel types operate together with the Busch-Ferncontrol® IR hand-held transmitter. The SMARTTouch B&O panel can alternatively also be controlled by the Bang&Olufson remote control Beo4.

The receiving range of a panel can be set. The IR colours "white", "blue" or "white & blue". It is possible to switch between colours with the help of a slide switch directly on the Busch-Ferncontrol® hand-held transmitter. If the IR range is set to "white & blue", the panel software indicates the individual push button pairs twice - once for the "white" IR range and a further time for the "blue" IR range.

The parameter "Bang&Olufson" only operates together with the SMARTTouch panel 6x36/100CB. If the IR range is set to "Bang&Olufson", the panel can either be operated via the Busch-Ferncontrol® IR hand-held transmitter or the Bang&Olufson Beo4 IR remote control.

Push button assignment

The individual push button pairs of the Busch-Ferncontrol® IR hand-held transmitter or the Bang & Olufson remote control Beo4 can be assigned the following functions:

- Switch,
- Dimmer,
- Shutter,
- Push button,
- Value
- and Lightscene external input.

The memo buttons of the IR hand-held transmitter or the push buttons green, orange, red, blue and stop of the Bang & Olufson remote control Beo4 can be used for sending lightscene numbers.

Switch

With the "Switch" function, a 1-bit communication object "Switch" is enabled for the push button pair. Switching telegrams are sent via this object to the linked actuators. The parameter "Behaviour" defines whether the right or the left push button switches "ON". The setting "TOGGLE" means that toggling is

always carried out when the right or left push button is pressed i.e. the communication object adopts a new value after each operation.

Example:

If the object currently has the value "1", the object adopts the value "0" after an operation and sends it. If the object has the value "0", the object value changes to "1" after an operation. The value "1" is of course also sent out after a change.

Dimmer

If the function of a push button pair is defined as a dimmer, the push button pair has two communication objects - a 1-bit object "Switch" for sending switching telegrams and a 4-bit object "Dim" for sending dimming telegrams.

A switching telegram (ON or OFF telegram) is always sent after a short operation. If a push button is operated for a long period (>0.5 s), a dimming telegram is triggered.

The parameter "Behaviour" defines whether dimming brighter or darker is carried out when the right or left push button is pressed.

Shutter

The shutter functionality of a push button pair causes a push button pair to send stop/step telegrams after a short operation and up/down telegrams after a long operation (>0.5 s) to linked shutter actuators.

The shutter function has two 1-bit communication objects - "Step" (stop/step) and "Move" (up/down).

The "Behaviour" parameter defines whether the shutter is raised or lowered when the right or left push button is pressed.

Push button

Via the "Push button" function, it is possible to send telegrams when a push button of the pair is pressed, released or pressed and released. A 1-bit communication object "Switch left" or "Switch right" is available for each push button of the pair.

The behaviour is defined via the corresponding parameter. When the push button is operated (on release), an ON, OFF or TOGGLE telegram can be sent. "TOGGLE" means that toggling is always carried out when the right or left push button is switched i.e. the communication object adopts a new value after each operation.

Example:

If the object currently has the value "1", the object adopts the value "0" after an operation and sends it. If the object has the value "0", the object value changes to "1" after an operation. The value "1" is of course also sent out after a change.

Value

A value telegram can also be triggered with a push button operation. To do so, the function must be set to "Value". In this case, the push button pair indicates a 1-byte communication object "Value" via which the value can be sent.

The parameters "Value push button left" and "Value push button right" define which values should be sent when the right or left push button is pressed. Various values between "0" and "255" can be set for the right and left push button.

Lightscene external input

The function "Lightscene external input" enables one of 32 lightscenes to be sent on each push button of the pair. The lightscenes are sent to linked lightscene modules via a 1-byte communication object "Lightscene number". This can either be the internal lightscenes which are stored in the panel or an external lightscene module.

The settings "Lightscene number left" and "Lightscene number right" define which lightscene number is sent.

By default, it is not possible to store lightscenes via the IR hand-held transmitter. This can be enabled via the parameter "Save lightscenes". In this case, the panel sends the lightscene number plus the save information if a push button is pressed for longer than 3 s. This means that an additional bit is set in

the lightscene telegram so that the linked lightscene modules know that they must now query the current status values of the actuators.

Lightscene number

If the "Lightscene number" function is used, only one push button e.g. M1 or M2 (no push button pair) is available for sending a lightscene. The function enables the retrieval of one of 32 lightscenes. The lightscenes are sent to linked lightscene modules via a 1-byte communication object "Lightscene number". These can either be the internal lightscenes which are stored in the panel or an external lightscene module.

The setting "Lightscene number" defines which lightscene number is sent.

By default, it is not possible to store lightscenes via the IR hand-held transmitter. This can be enabled via the parameter "Save lightscenes". In this case, the panel sends the lightscene number plus the save information if a push button is pressed for longer than 3 s. This means that an additional bit is set in the lightscene telegram so that the linked lightscene modules know that they must now query the current status values of the actuators.

Remote control via Bang & Olufsen hand-held transmitter Beo4

The IR hand-held transmitter offers the following options for controlling the panel.

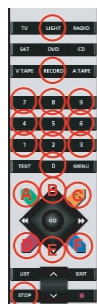

Button description Beo4:

- Light: Changing of illumination
- Record: Saving of lightscene
- 0 – 9: Light 1 up to 10
- A: Lightscene 1
- C: Lightscene 2
- D: Lightscene 3
- F: Lightscene 4
- B: On or dimming brighter
- E: Off or dimming darker
- Stop: All Off

Switching and dimming:

Press the “LIGHT” button on the remote control. The text “LIGHT” appears in the display of the remote control. This mode is active for 25 seconds. If the display switches to audio/video playback again, the “LIGHT” button must be pressed again.

Once the LIGHT mode is active, the push buttons for triggering the required function follow. See the table.

The format LIGHT + 1 + B means that the three push buttons must be pressed in sequence (not simultaneously).

Function	Push buttons
Light 1 on	LIGHT + 1 + B
Light 1 dimming brighter	LIGHT + 1 + B, B long push
Light 1 off	LIGHT + 1 + E
Light 1 dimming darker	LIGHT + 1 + E, E long push
Light 2 up to 9 analogue to Light 1	–
Light 10 on	LIGHT + 0 + B
Light 10 dimming brighter	LIGHT + 0 + B, B long push
Light 10 off	LIGHT + 0 + E
Light 10 dimming darker	LIGHT + 0 + E, E long push

Retrieving and saving lightscenes

Press the “LIGHT” button on the remote control. The text “LIGHT” appears in the display of the remote control. This mode is active for 25 seconds. If the display switches to audio/video playback again, the “LIGHT” button must be pressed again.

Once the LIGHT mode is active, the push buttons for triggering the required function follow. See the table.

The format LIGHT + A means that the two push buttons must be pressed in sequence (not simultaneously).

Function	Push buttons
Call Lightscene 1	LIGHT + A
Call Lightscene 2	LIGHT + C
Call Lightscene 3	LIGHT + D
Call Lightscene 4	LIGHT + F
Save Lightscene 1	LIGHT + RECORD + A
Save Lightscene 2	LIGHT + RECORD + C
Save Lightscene 3	LIGHT + RECORD + D
Save Lightscene 4	LIGHT + RECORD + F

ALL OFF

All the loads are switched off with one push button action when the “STOP” button is pressed.

Functional description: IR control
 General settings.

- IR range	white blue white & blue Bang & Olufson (only 6x36/100CB)
------------	--

Functional description: IR control for Busch-Ferncontrol® IR hand-held transmitter

blue=blue infrared range

white=white infrared range

Function	Application
Push button pair 1 (blue/white)	Inactive Switch Dimmer Shutter Push button Value Lightscene external input
Push button pair 2 (blue/white)	Inactive Switch Dimmer Shutter Push button Value Lightscene external input
...	
Push button pair 5 (blue/white)	Inactive Switch Dimmer Shutter Push button Value Lightscene external input
Memo push button M1 (blue/white)	Inactive Lightscene number
Memo push button M2 (blue/white)	Inactive Lightscene number
Memo push button Rot (blue/white)	Inactive Lightscene number

Functional description: IR remote control for Bang&Olufson remote control Beo4

Function	Application
Push button 1 up/down	Inactive Switch Dimmer Shutter Push button Value Lightscene external input
Push button 2 up/down	Inactive Switch Dimmer Shutter Push button Value Lightscene external input
...	
Push button 9 up/down	Inactive Switch Dimmer Shutter Push button Value Lightscene external input

Functional description: IR control for Bang&Olufson remote control

Push button 0 up/down	Inactive Switch Dimmer Shutter Push button Value Lightscene external input
Push button A green	Inactive Lightscene number
Push button B orange	Inactive Lightscene number
Push button C red	Inactive Lightscene number
Push button D blue	Inactive Lightscene number
Push button stop	Inactive Lightscene number

Communication objects
for "Switch"

No.	Type	Object name	Function
0	1 bit	Switch	Send/Receive

Communication objects
for "Dimmer"

No.	Type	Object name	Function
0	1 bit	Switch	Send/Receive
1	1 bit	Dim	Send

Communication objects
for "Shutter"

No.	Type	Object name	Function
0	1 bit	Move	Send
1	1 bit	Step	Send

Communication objects
for "Push button"

No.	Type	Object name	Function
0	1 bit	Switch left	Send
1	1 bit	Switch right	Send

Communication objects
for "Value"

No.	Type	Object name	Function
0	1 byte	Value	Send

Communication objects
for "Lightscene external input" and
"Lightscene number"

No.	Type	Object name	Function
0	1 byte	Lightscene number	Send

Parameters: IR control “Switch”

The default setting for the values is **printed in bold type**.

– Behaviour	Left=on, right=off Left=off, right=on Left=toggle, right=toggle
-------------	--

Parameters: IR control “Dimmer”

The default setting for the values is **printed in bold type**.

– Behaviour	Left brighter on, right darker off Left darker off, right brighter on Left brighter toggle, right darker toggle Left darker toggle, right brighter toggle
-------------	---

Parameters: IR control “Shutter”

The default setting for the values is **printed in bold type**.

– Behaviour	Left=up/right=down Left=down/right=up
-------------	---

Parameters: IR control “Push button”

The default setting for the values is **printed in bold type**.

– Push button left	Send off at rising flank Send off at falling flank Send off at both flanks Send on at falling flank Send off at rising flank, on at falling flank Send on at rising flank Send on at rising flank, off at falling flank Send on at both flanks Toggle at rising flank
– Push button right	Send off at rising flank Send off at falling flank Send off at both flanks Send on at falling flank Send off at rising flank, on at falling flank Send on at rising flank Send on at rising flank, off at falling flank Send on at both flanks Toggle at rising flank

Parameters: IR control “Value”

The default setting for the values is **printed in bold type**.

– Value push button left	0
– Value push button right	255

Parameters: IR control “Lightscene external input”

The default setting for the values is **printed in bold type**.

– Lightscene number left (1...32)	1
– Lightscene number right (1...32)	2
– Save lightscenes	not possible possible

Parameters: IR control “Lightscene number”

The default setting for the values is **printed in bold type**.

– Lightscene number memo push button (1...32)	11
– Save lightscenes	not possible possible

Functional description: Room thermostat

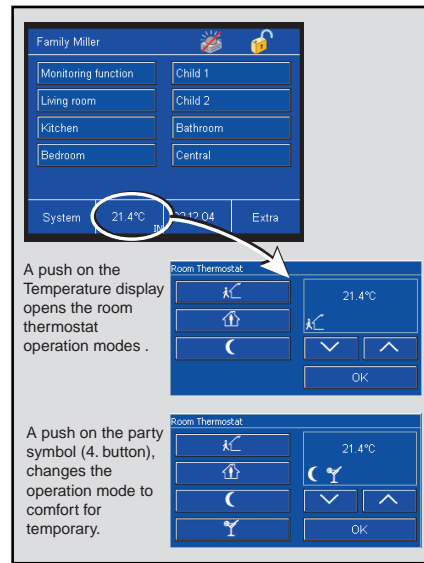

the room temperature is lowered to a pleasant night temperature and can be increased again relatively quickly in the morning.

It is possible to toggle between these operating modes through switching telegrams to the communication objects "Frost protection", "Night" and "Comfort" or via the panel display (see also the diagram of the operating modes). The frost/heat protection has the highest priority i.e. it is not possible to switch to another operating mode in this case. To do so, the frost/heat protection mode must first be deactivated e.g. by closing an open window. Comfort mode has the next highest priority followed by night mode. If none of the three operating modes is active, the room thermostat is in standby mode.

The LEANtouch/SMARTtouch panel has an integrated room thermostat. This has a comparable functionality to the usual EIB room thermostats.

Operating modes

- The room thermostat function has four operating modes:
- Frost protection mode:
 The room temperature control is out of service; the room is only heated if the room temperature has fallen so low that there is a risk of the heating installation freezing.
 - Comfort mode:
 The setpoint for the room temperature is set to a value which enables "normal use" of the room at a pleasant temperature.
 - Standby mode:
 The room temperature is lowered (e.g. during temporary absence) so that heating costs are saved but the comfort temperature can be reached again quickly.
 - Night mode:
 If the room is not used for an extensive period during the night;

Party time (Comfort extension)

If the panel is switched to night mode via the bus (or internally), the party time can be activated via the panel display (change to comfort mode, see diagram top left). Once the party time has elapsed, the thermostat switches back to night mode.

During the party time, the symbols for night and party are shown together in the display. By pressing the party button again, the party time can be reset manually to night reduction.

This function can also be used for the temporary deactivation of the heat and frost protection. As in night mode, it is possible to switch to comfort mode for the parameterised period. The function is switched on and off in the same way. The symbols for frost protection and party are shown together in the display during this comfort extension.

Priorities of the operating modes

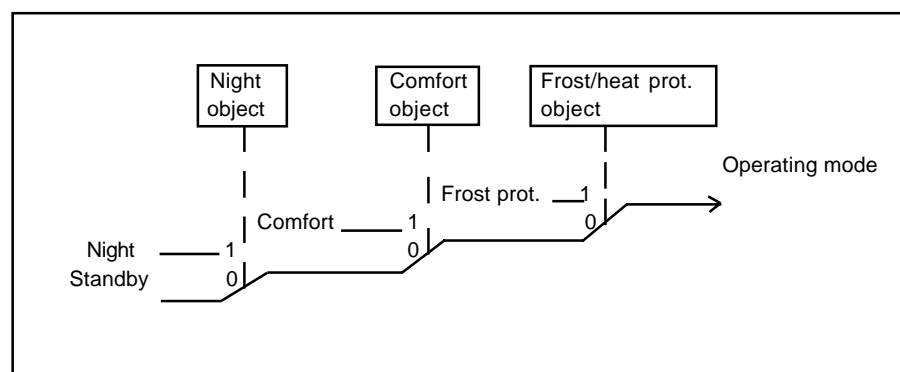

If the party time is inactive, the first button with comfort/standby toggling also directly operates the comfort object. It is therefore possible to set the operating mode directly to comfort mode while in night mode. When the frost or heat protection mode is active, toggling via the first button is stored in the comfort object.

The recording of the actual temperature is normally carried out by a built-in temperature sensor. It is also possible to switch to an external measurement with the parameter "Actual value survey". Temperature values which are received via the object "Actual temperature" can thus be used for control purposes. If no new values are received for 30 min, the thermostat suspends its function and no more control value telegrams are sent.

Setpoint values

The following setpoint values can be set for heating mode: "Base setpoint in °C (16..31) (Comfort temperature heating)", "Lowering standby operation heating ... (1..15)", "Lowering night operation heating in K (1..15)" and "Setpoint frost protection in °C (4..10)".

For cooling mode, the comfort temperature can be set via the "Dead zone between heating and cooling in K (1..8)". The setpoint adjustments for standby and night mode refer to this value: "Increasing standby operation cooling" and "Increasing night operation cooling".

If e.g. a room should be cooled at 25°C in comfort mode with a base setpoint of 22°C, a dead zone of 3°C must be set. If it should now be cooled at 27°C in standby mode, the value must be increased by 2°K. Cooling in night mode from 29°C requires an increase in this value of 4°K.

To protect against uncontrolled overheating of rooms, it is possible to assign a setpoint for heat protection after which cooling takes place. If heat protection is not required, cooling can be switched off.

Setpoints in the different operating modes

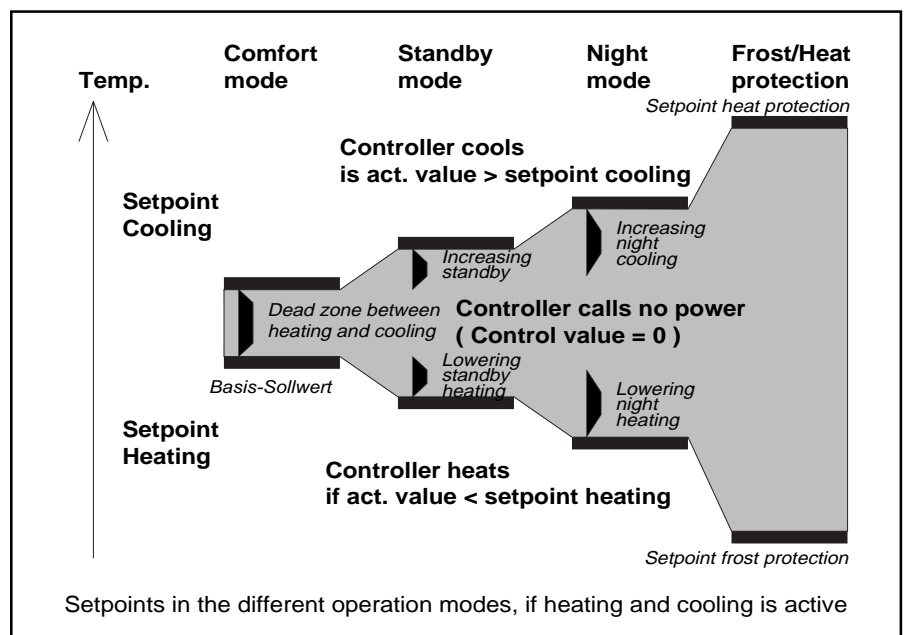

The base setpoint can be modified as often as necessary via the bus. To do so, a 2-byte temperature value must be sent to the object "Base setpoint".

The setpoint temperature can be changed manually via the rocker buttons on the panel display. The parameters "Area for manual setpoint setting", "Maximum increasing of setpoint at heating" and "Maximum lowering of control value at cooling" determine the scope for modifying the setpoint. If a new telegram is sent to the communication object "Base setpoint" after a manual setpoint adjustment, the manual setpoint adjustment can also be reversed.

Heating/cooling

To be able to address the various controller types for heating or cooling mode, the room thermostat can be parameterised as a continuous or switching controller. In the case of a switching controller, it is possible to choose between a PWM controller ("PI controller") and a "Two-position controller".

In the case of a continuous control response and a switching PWM controller, the preset control parameters regarding the installation type of the heating or air conditioning system can be used. If other control parameters are needed, they can be set individually via the free parameterisation option. This option should only be used if the user has sufficient experience in control technology.

The continuous controller sends its control value to a 1-byte object. Electromotive or electrothermal drives which are connected to heating actuators with PWM control can thus be controlled.

To prevent unnecessary bus loads, it is possible to set by how much the control value must change in order to be sent on the bus. The setting is carried out as a percentage. The sending of the control value is preset by a cyclic period, provided it has not been modified. This cycle time should not be set too low (e.g. every 10 min).

In the case of a switching PWM controller, the output value of the controller (0...255) is converted into an ON/OFF ratio. If e.g. a control value of 70% should be issued, the ON time is 7 min and the OFF time is 3 min at a preset cycle time of 10 min. The dynamic range can also be limited in the same way as a continuous controller. The parameters "PWM cycle is 0% up to control value" and "PWM cycle is 100% up to control value" are used for this purpose. If e.g. a maximum control value of 80% is set, the controller automatically sends the value 255 when a control value of 204 is exceeded. (See also the diagram below)

To optimise the control characteristics of the heating or cooling system, the "Cycle time of the control value" can be set. To set the correct cycle time, the type of heating or cooling as well as the valve drive used should be taken into account. The following recommendations can be used:

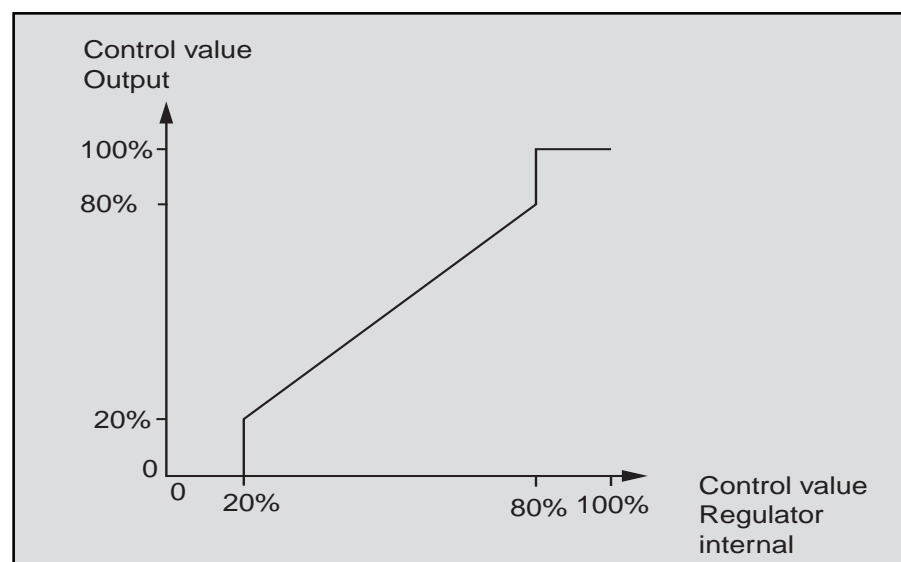

a) Electrothermal valve drive:

To fully open an electrothermal valve drive takes approx. 2-3 minutes. A shorter cycle time than 15 minutes is therefore not advisable.

b) Floor heating:

The time constant of a floor heating system is very high. A cycle time of 20 minutes is therefore sufficient.

c) Warm water heating:

Electrothermal drives are frequently used here. A cycle time of 15 minutes produces very good results.

d) Electric fan heating:

Cycle times between 10 and 15 minutes are recommended, depending on the electric heating and spatial conditions.

If a two-position controller is used for heating or cooling control, it is possible to select the hysteresis by which the setpoint fluctuates. If e.g. the setpoint in heating mode is 20°C and the hysteresis is 0.5 K, the controller switches on at 19.75°C and switches off again at 20.25°C. The hysteresis that is set then depends on how quickly the heating can heat up the room or how quickly the cooling cools down the room as well as how sensitive the customer is to temperatures. The hysteresis should not be set too low as otherwise the valve drive continually opens and closes. The hysteresis should however not be set too high as the temperature fluctuations in the room are then relatively high.

To increase the accuracy of the control, the parameter "Lowering of hysteresis" is used. If this parameter is active the hysteresis is reduced e.g. every minute by 0.1 K, if required until 0 K. The temperature fluctuations are effectively reduced during the control by the lowered hysteresis. If a reduction should be used, it is advisable to select a reduction that is less than one fifth of the hysteresis.
e.g. Hysteresis 0.5 K =>

Reduction < 0.1 K/min

In certain cases (floor heating), it may be necessary to install a fast-acting additional system to enable you to heat the room up quickly. If the "Additional heating" is active, the panel has a second heating system available with a switching control (1 bit) or a quasi continuous control which regulates the heating with the 1-byte values 0% and 100%.

With the parameters "Level distance from the base level to the additional level in K" and "Hysteresis (one-sided)", it is determined when the additional level is switched on and when it is switched off. If e.g. the setpoint for the second heating level is set at 18°C with a hysteresis at 0.5 K (one-sided), the thermostat switches on at 18°C and switches off at 18.5°C.

As some valve drives close at a 1-byte value of 255 or a 1-bit value of 1 and open at the corresponding inverted values, the "Effective mode" can be inverted.

The toggling between heating and cooling is carried out automatically by the room thermostat. If this is not required, the "Toggle between heating and cooling" can be carried out by an external, central control via the 1-bit object "Toggle heating cooling". In this setting, the heating or cooling symbols are permanently visible during the corresponding operating mode. If an ON telegram is received at the operating mode object, the heating mode is switched on. If an OFF telegram is received, the cooling mode is switched on.

Automatic shading

To prevent the room warming up due to sunlight, automatic shading can be carried out by lowering one or several blinds. The object "Shading" is used for this purpose.

The parameter "Shading setpoint" determines at which temperature the blinds should be lowered.

If the temperature falls below the set shading temperature, no commands for lowering the blinds are sent. The blinds could be raised at a specific time e.g. with a central command.

Group master mode

In rooms such as large open-plan offices, it can be difficult to achieve effective control throughout the room with only one panel operating as a room thermostat. In such cases, it is advisable to divide the room into several zones in which one room thermostat is used per zone. So that these room thermostats always use the same setpoint, the-

re is the possibility of activating the parameter "Group master operation mode" for one device. In this case, this device has the 2-byte communication object "Base setpoint for slaves" which is linked with the 2-byte communication objects "Base setpoint - Telegr. temperature" of the other devices. The manual setpoint adjustment should then be disabled for these objects. The operating modes heating/cooling or frost/night/comfort must be set exactly the same on the master and slave devices by configuring or assigning the same group addresses to the operating mode objects.

Offset

If the measured temperature is corrupted by the self-heating of the panel, an offset value can be set for the room temperature measurement (setting "Offset value in K x 0.1 K").

The installation site of the panel and the appropriate selection of parameter settings is decisive in the accurate recording of temperatures.

ABB i-bus® EIB
 ABB Powernet EIB

LEANtouch (monochrome),
 SMARTtouch (monochrome, colour)
 Type: 6x36/30M(-500), 6x36/100x(-500), 6x36/100CB

Functional description: Room thermostat

Function	Application
RT	Inactive Heating/Heating and cooling

Communication objects

No.	Type	Object name	Function
0	1 bit	Frost protection	Receive
1	1 bit	Night	Send/Receive
2	1 bit	Comfort	Send/Receive
3	2 byte	Base setpoint	Receive
4	2 byte	Actual temperature	Send
5	2 byte	Act. setpoint	Send
6	1 bit	Shading	Send
7	1 bit	Heating switched	Send
8	1 bit	Additional heating switched	Send
9	1 bit	Cooling switched	Send
10	1 bit	Toggle heating cooling	Send/Receive

No.	Type	Object name	Function
...			
5	2 byte	Base setpoint for slaves	Send
...			
7	1 byte	Heating continuously	Send
8	1 byte	Additional heating continuously	Send
9	1 byte	Cooling continuously	Send
...			

Parameters: Room thermostat
 The default setting for the values
 is **printed in bold type**.

General:	
- Control heating	Active
- Control additional heating	Inactive Active
- Control cooling	Inactive Active
- Operation mode after reset	Comfort Standby Night Frost protection
- Cyclic sending of actual value and setpoint in mm.ss (03:00...60:00)	14:50
- Change of actual temp. for automatic sending	Inactive / 0.2 K / 0.4 K / 0.6 K / 0.8 K / 1.0 K / 1.5 K / 2.0 K
- Automatic shading (see also setpoints)	Inactive Active
- Party time (extension of comfort mode)	Inactive / 30 min / 1 h / 1.5 h / 2 h / 2.5 h / 3 h / 4 h
- Display heating/cooling is active	If operation mode is active At heating resp. cooling
- Group master operation mode	Inactive Active
- Disable frost/heat protection manually (extension of comfort mode)	Locked Free
- Actual value survey	Internal External
- Toggle between heating and cooling	automatic via object
- Offset value in K x 0.1 K	0
Setpoints general:	
- Area for manual setpoint setting	Disabled / +- 1K / +- 3K / +- 5K
- Maximum increasing of setpoint at heating in K (0...5)	3
Only for cooling:	
- Maximum lowering of setpoint at cooling in K (0...5)	3
- Send actual setpoint at change	Inactive Active
- Manual setpoint setting	Reset at receiving of base setpoint Hold at receiving of base setpoint
Only for shading:	
- Shading setpoint	Comfort temperature + 2K Comfort temperature + 4K Comfort temperature + 6K Comfort temperature + 8K
- Temperature display at setpoint adjustment	Act. setpoint Base setpoint

Parameters: Room thermostat
 The default setting for the values
 is **printed in bold type**.

Setpoints heating:	
– Base setpoint in °C (16...31) Comfort temperature heating	21
– Lowering standby operation heating in K (1...15)	2
– Lowering night operation heating in K (1...15)	4
– Setpoint frost protection in °C (4...10)	7
– Level distance from the base level to the additional level in K	3
Controlling/Control value heating:	
– Output of control value	continuously switched
– Control type	Two-position controller PI controller
Only for two-position controller:	
– Hysteresis	0.3K / 0.5K / 0.7K / 1K / 1.5K / 2K
– Lowering of hysteresis	Inactive 0.2 K/min 0.1 K/min 0.06 K/min 0.04 K/min 0.03 K/min 0.02 K/min
– Cycle time of the control value in mm:ss (03:00...60:00)	14:50
Only for continuous controller:	
– Change for automatic sending of control value	Inactive / 2% / 5% / 10%
Only for PI controller:	
– Control parameters	via installation type free setting of parameters
Only for installation type:	
– Type of heating system	Warm water heating (1.5K/100min) Electric heating (1.5K/50min) Floor heating (4K/200min)
Only for free parameterisation:	
– Proportional area	1.0K / 1.5K / 2.0K / 2.5K / 3K / 4K / 6K / 8K / 10K
– Reset time in min.	I part inactive / 10 min / 20 min / 30 min / ... / 100 min / ... / 240 min
Only for switched controller:	
– PWM cycle	3min / 5min / 10min / 15min / 20min / 30min / 40min / 50min / 60min
– PWM cycle is 0% up to control value	0% / 10% / 20% / 30%
– PWM cycle is 100% up to control value	70% / 80% / 90% / 100%
– Effective mode	Normal Inverted
Only for additional heating:	
– Hysteresis (one-sided)	0.3K / 0.5K / 0.7K / 1.0K / 1.5K / 2.0K
– Cycle time for automatic sending of the control value e in mm:ss (03:00...60:00)	14:50
– Control value type	switched quasi contin. (1 Byte: 0% or 100%)
– Effective mode	Normal Inverted

Parameters: Room thermostat
 The default setting for the values
 is **printed in bold type**.

Only for cooling:	
Setpoints cooling:	
- Dead zone between heating and cooling in K (1...8)	4
- Increasing standby operation cooling	2
- Increasing night operation cooling	4
- Setpoint heat protection	Cooling switched off 30°C 35°C 40°C 44°C
Controlling/Control value cooling:	
- Output of control value	continuously switched
- Control type	Two-position controller PI controller
Only for two-position controller:	
- Hysteresis	0.3K / 0.5K / 0.7K / 1.0K / 1.5K / 2.0K
- Lowering of hysteresis	Inactive 0.2 K/min 0.1 K/min 0.06 K/min 0.04 K/min 0.03 K/min 0.02 K/min
- Cycle time of the control value in mm:ss (03:00...60:00)	04:46
- Effective mode	Normal Inverted
Only for PI controller:	
- Control parameters	via installation type free setting of parameters
- Type of cooling system	Cooling ceiling (5K/240min) SplitUnit/Fan cooling (4K/90min)
- PWM cycle	3min / 5min / 10min / 15min / 20min / 30min / 40min / 50min / 60min
- PWM cycle is 0% up to control value	0% / 10% / 20% / 30%
- PWM cycle is 100% up to control value	70% / 80% / 90% / 100%
- Effective mode	Normal Inverted
Only for free parameterisation:	
- Proportional area	1.0K / 1.5K / 2.0K / 2.5K / 3K / 4K / 6K / 8K / 10K
- Restet time in min.	I part inactive / 10 min / 20 min / ... 100 min / ... / 200 min / 240 min
Only for continuous controller:	
- Cycle time of the control value in mm:ss (03:00...60:00)	04:46
- Effective mode	Normal Inverted
- Change for automatic sending of control value	Inactive / 2% / 5% / 10%

Functional description: Lightscenescenes
General settings

General

The LEANtouch/SMARTtouch panel can be used to send and save lightscenescenes. Up to 20 EIB actuators can be addressed via the memo communication objects. The number of memo objects available to the panel is dependent on the type used and on the setting "Number of objects per lightscene". This can be a maximum of 20 (6 for LEANtouch) objects.

The 1-byte communication object "Lightscene number" is used for retrieving lightscenescenes. The panel receives one of 32 lightscene numbers at this object. These lightscene numbers can be retrieved internally in the panel e.g. via a touch surface with the appropriate settings or externally via an EIB switch sensor.

If the panel receives a lightscene telegram at its memo objects, it will send switching or value telegrams in sequence to linked actuators. The "Telegram rate between two lightscene telegrams" can be set. In the Powernet version, this should not be set too low as otherwise the bus load is excessively increased. The preset value of "1 s" should be sufficient and should be changed if necessary. In the Twisted Pair variant, the telegram rate is not critical and can be lowered if necessary.

Lightscene

The size of the memo communication objects can be adapted to switch, dimming or shutter actuators. This means that if a switch or shutter actuator should be addressed via a memo object, the object is 1 bit. If a dimming actuator should be addressed, the object is 1 byte. The bit size is defined individually for each memo object via the parameter "Actuator type".

The LEANtouch/SMARTtouch panel software displays various options depending on the selection.

With the selection "Switch or shutter actuator", it is possible to set "Off/Up" or "On/Down". Alternatively, an actuator can also be "Inactive" within a scene.

If "Dim actuator" is set as the actuator type, percentage values of 0% to 100% can be set in increments of 10%.

Saving lightscenescenes

If the end customer would like to carry out changes to the predefined lightscenescenes, he can do this without any great effort. He must first set all the lamps and/or shutters to the required position i.e. he dims or moves the individual components via separate EIB switch sensors or via the touch surfaces of the panel. He then triggers a lightscene storage telegram with a long operation (> 3 s) of a lightscene touch surface or an additional lightscene switch sensor. This telegram is received at the object "Lightscene number". The individual memo objects now send read requests to the linked EIB actuators. If the read flag is set for these objects, the actuators send back their current values in response telegrams. These values are stored in the panel and are not lost in the event of a bus voltage failure.

If changes are carried out on the LEANtouch/SMARTtouch panel and then programmed in the panel, lightscenescenes that have been stored by end customers are likewise not lost by default. This behaviour can also be modified via the parameter "Overwrite lightscene settings at download". All the lightscenescenes can thus be reset to the preset options which were carried out with the panel software.

Functional description: Lightscenes
General settings

General:	
– Number of objects per lightscene (1...20)	8
– Telegram rate between two lightscene telegrams	130ms / 260ms / 520ms / 1s / 2s / 4s / 10s / 35s
– Overwrite lightscene settings at download	No / Yes

Functional description: Lightscenes
Application

Function	Application
Lightscene actuator	Lightscene

Communication objects for 1-bit actuator types

No.	Type	Object name	Function
0	1 byte	Lightscene number	Receive
1	1 bit	Memo object 1	Send/Receive
2	1 bit	Memo object 2	Send/Receive
3	1 bit	Memo object 3	Send/Receive
4	1 bit	Memo object 4	Send/Receive
5	1 bit	Memo object 5	Send/Receive
6	1 bit	Memo object 6	Send/Receive
7	1 bit	Memo object 7	Send/Receive
8	1 bit	Memo object 8	Send/Receive
9	1 bit	Memo object 9	Send/Receive
10	1 bit	Memo object 10	Send/Receive
11	1 bit	Memo object 11	Send/Receive
12	1 bit	Memo object 12	Send/Receive
13	1 bit	Memo object 13	Send/Receive
14	1 bit	Memo object 14	Send/Receive
15	1 bit	Memo object 15	Send/Receive
16	1 bit	Memo object 16	Send/Receive
17	1 bit	Memo object 17	Send/Receive
18	1 bit	Memo object 18	Send/Receive
19	1 bit	Memo object 19	Send/Receive
20	1 bit	Memo object 20	Send/Receive

Communication objects for 1-byte actuator types

No.	Type	Object name	Function
0	1 byte	Lightscene number	Receive
1	1 byte	Memo object 1	Send/Receive
2	1 byte	Memo object 2	Send/Receive
3	1 byte	Memo object 3	Send/Receive
4	1 byte	Memo object 4	Send/Receive
5	1 byte	Memo object 5	Send/Receive
6	1 byte	Memo object 6	Send/Receive
7	1 byte	Memo object 7	Send/Receive
8	1 byte	Memo object 8	Send/Receive
9	1 byte	Memo object 9	Send/Receive
10	1 byte	Memo object 10	Send/Receive
11	1 byte	Memo object 11	Send/Receive
12	1 byte	Memo object 12	Send/Receive
13	1 byte	Memo object 13	Send/Receive
14	1 byte	Memo object 14	Send/Receive
15	1 byte	Memo object 15	Send/Receive
16	1 byte	Memo object 16	Send/Receive
17	1 byte	Memo object 17	Send/Receive
18	1 byte	Memo object 18	Send/Receive
19	1 byte	Memo object 19	Send/Receive
20	1 byte	Memo object 20	Send/Receive

Functional description: Alarm function

The panel offers the possibility of displaying up to 10 different alarm messages. The parameter "Number of alarm messages" defines the required number.

Each alarm message has its own communication object "Alarm 1" to "Alarm 10". The communication objects can either be 1 bit or 14 byte. The setting "Type of the alarm object" sets the size of the object. Each alarm object can thus be set individually.

The alarm function can be used in combination with the inputs of the monitoring function (see page 18) or on its own. In combination with the monitoring function, the inputs and the alarm objects must be linked via internal group addresses.

If a telegram e.g. an ON telegram is received at an alarm object, a window is opened in the screen of the panel, in which the alarm text is displayed. The alarm text can be freely entered in the panel software. The panel simultaneously triggers a signal tone. The duration of the signal tone can be set and it can also be deactivated.

All alarm messages which occur or have occurred can be displayed via a further window in the panel. The window is opened by pressing the "Extras" button followed by "Alarm messages/Fault messages". All alarm and fault messages are displayed with the date, time and acknowledgement.

The acknowledgement of an alarm message is carried out via the "OK" button in the alarm text window. If the setting "Send zero at acknowledge" has been activated with "yes" for a 1-bit alarm object, the group address that is linked with the alarm object is sent on the bus with the value "0".

In the case of a 14-byte alarm object, an individual acknowledgement text (max. 13 characters) can be sent with the acknowledgement.

Via the acknowledgement object "Acknowledge global", a group address is sent as soon as an acknowledgement has been carried out at one of the alarm objects.

Functional description: Alarm function

Function	Application
Alarm messages	Inactive Settings

Communication objects for 1-bit alarm messages

No.	Type	Object name	Function
0	1 bit	Acknowledge global	Send
1	1 bit	Alarm 1	Send/Receive
2	1 bit	Alarm 2	Send/Receive
3	1 bit	Alarm 3	Send/Receive
4	1 bit	Alarm 4	Send/Receive
5	1 bit	Alarm 5	Send/Receive
6	1 bit	Alarm 6	Send/Receive
7	1 bit	Alarm 7	Send/Receive
8	1 bit	Alarm 8	Send/Receive
9	1 bit	Alarm 9	Send/Receive
10	1 bit	Alarm 10	Send/Receive

Communication objects for 14-byte alarm messages

No.	Type	Object name	Function
...			
1	14 byte	Alarm 1	Send/Receive
2	14 byte	Alarm 2	Send/Receive
3	14 byte	Alarm 3	Send/Receive
4	14 byte	Alarm 4	Send/Receive
5	14 byte	Alarm 5	Send/Receive
6	14 byte	Alarm 6	Send/Receive
7	14 byte	Alarm 7	Send/Receive
8	14 byte	Alarm 8	Send/Receive
9	14 byte	Alarm 9	Send/Receive
10	14 byte	Alarm 10	Send/Receive

Parameters: Alarm function

The default setting for the values is **printed in bold type**.

General:	
- Number of alarm messages (1...10)	5

Separate for each alarm message:

Alarm message...:	
- Type of the alarm object ...:	1 Bit / 14 Byte
Only for 1 bit:	
- Text for alarm message	<Text>
- Text at acknowledge	<Text>
- Send zero at acknowledge	No / Yes
Only for 14 byte:	
- Send text at acknowledge	No / Yes
Only if "Yes" is selected:	
- Text at acknowledge	<Text>
- Time of the audio signal	No signal 30 s 1 min 2 in 5 min 10 min 30 min 1 h

Functional description: Presence simulation

The panel has an integrated presence simulation function. This means that the panel can send out telegrams fully independently and conveys the impression that the house is occupied.

If the presence simulation function is activated, the panel software displays 10 x 1-bit communication objects "Simulation 1" to "Simulation 10" for controlling switch and/or shutter actuators and a 1-bit communication object "Activation" for the activation or deactivation of the presence simulation.

The presence simulation is activated with an ON telegram at the "Activation" object. An OFF telegram deactivates it again.

If the presence simulation is not active (OFF telegram has been received at the activation object), it portrays "normal" telegram traffic. The panel learns the habits of the occupants of the house. The panel has a memory which records telegrams for seven days. On the eighth day, the memory location of the first of the seven days is overwritten.

If the panel only had three days to carry out a recording, only these three days are repeated when the function is activated.

The panel ignores cyclical transmitters during the recording. This means it only records an actual change.

Once an ON telegram has been received at the "Activation" object, the panel first waits until the "Waiting time up to the activation" has elapsed. Only then does the simulation start. The delay can be set between 30 s and 2 min.

The activated presence simulation sends the information that has been recorded over several days on a 1:1 basis.

It is a good idea to integrate functions in the presence simulation which are not linked with a holiday function of a time channel. This could be e.g. the lounge light, the kitchen light and above all the hallway light.

Functional description: Presence simulation

Function	Application
Simulation	Inactive Active

Communication objects

No.	Type	Object name	Function
0	1 bit	Activation	Receive
1	1 bit	Simulation 1	Send/Receive
2	1 bit	Simulation 2	Send/Receive
3	1 bit	Simulation 3	Send/Receive
4	1 bit	Simulation 4	Send/Receive
5	1 bit	Simulation 5	Send/Receive
6	1 bit	Simulation 6	Send/Receive
7	1 bit	Simulation 7	Send/Receive
8	1 bit	Simulation 8	Send/Receive
9	1 bit	Simulation 9	Send/Receive
10	1 bit	Simulation 10	Send/Receive

Parameters: Presence simulation

The default setting of the values is printed in bold type.

- Waiting time up to the activation	30s / 40s / 50s / 1min / 1.1min / 1.2min / 1.5 min / 2 min
-------------------------------------	---

Functional description: Logical functions (1...8)

E1: Input 1
 E2: Input 2
 A: Output

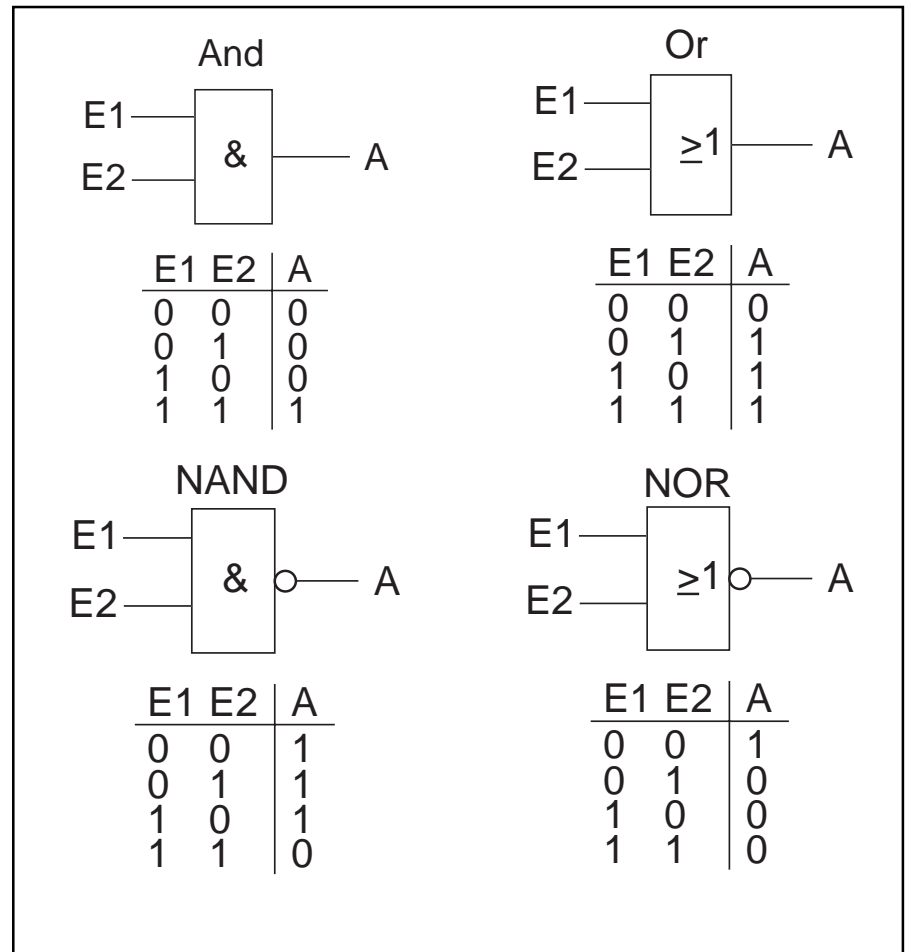

Up to 8 different logic functions can be integrated in the panel. Each logic function can adopt one of the following functions:

- AND
- OR
- NAND
- NOR
- Multiplexer
- Multiplier
- Gate
- Temperature comparator 1110
- Temperature comparator 2110

AND, OR, NAND and NOR

If the function is defined with AND, OR, NAND or NOR, up to four input communication objects can be enabled per logic function. The size of the inputs can either be 1 bit or 1 byte. When a new telegram is received at the input, it is switched according to the selected function. In addition, the inputs can be inverted together.

Example of "AND" 1-byte inputs:
 If the inputs are 1 byte, all the input values must be greater than "0" in order to achieve a positive result.

Example of inverted "AND" 1-byte inputs:
 If the inputs are 1 byte and inverted, all the input values must be equal to "0" in order to achieve a positive result.

Each function has an output object to which the result determined from the inputs is sent. The output object can be 1 bit or 1 byte, depending on the parameterisation. The default value which should be sent in the event of a positive result can be set. In addition, a delay for sending the output signal can also be selected.

It is also possible to set an output filter. This means that either only "On", only "Off" or "On and Off" can be sent for a 1-bit output object. With a 1-byte output object, it can be set whether "only the given value", "only Off" or "only the given value and Off" should be sent.

So that the inputs are not undefined after a voltage failure and subsequent voltage recovery, there is the parameter "Behaviour of inputs after reset". The inputs can either be read i.e. send read requests to the linked objects which leads to an increased bus load or the inputs can adopt default values which can be defined in the parameters.

Multiplexer

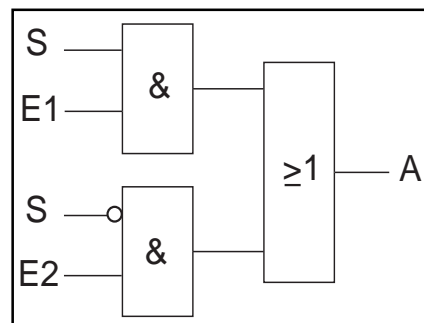

Via the "Multiplexer" logic function, the input data to the output can be controlled directly. The function has four communication objects "Controller", "Input 1", "Input 2" and "Output". The diagram above indicates the function of a 1-bit multiplexer (S=Controller, E1=Input 1, E2=Input 2, A= Output).

The bit size of the inputs and outputs can be set to 1 byte or 2 byte via the parameter "Object type input/output". The above functionality is thereby retained. That means that only input 1 is visible at the output if the control input has the value "1". Input 2 is switched to the output as soon as the control input has the value "0".

Note:

The output is only sent when there is an actual change of the inputs. If e.g. the control input changes without the input value changing, the output signal remains as it is. A new output value is sent only if an input signal changes.

Multiplier

The "Multiplier" function enables up to four output telegrams to be sent with an input telegram. The input communication object is 1 bit. The output communication objects can either be 1 bit or 1 byte.

The size is set via a corresponding parameter.

It can be defined via the setting "Starting conditions" whether a duplication of an input telegram should be triggered after an ON or OFF telegram. Moreover, there is the possibility of sending output telegrams with a time delay. By default, a delay of 1 s is defined.

The useful information (values) which should be sent with the output telegrams can be set individually for each output via a corresponding parameter. For 1-bit outputs, this is "On" or "Off" while for 1-byte outputs, values between "0" and "255" can be assigned.

Gate

With the "Gate" logic function, it is possible to filter specific signals and to disable the signal flow temporarily. The function has three communication objects "Control input", "Input" and "Output".

The control input is 1 bit and the input and output objects are likewise 1 bit by default. The object types at the input and output can also be set to "not assigned". That means that the bit size can be freely assigned. The first internal or external group address which is assigned and is already linked with another communication object defines the size.

The control is always carried out from input to output provided that this is permitted by the control input. The activation via the control input can be carried out via an ON or an OFF telegram. If the setting "Control input" is set to "ON telegram" for example, only telegrams from the input to the output are routed if a "1" has previously been received at the control input.

For 1-bit input and output objects, it can be set whether the input signals should be saved or not "During the blocking". If the setting "Store input signal" is selected, the output sends its value if a telegram has been received at the input during the blocking.

If the input and output objects are 1 bit, it is possible to invert the output. An inversion element can therefore be implemented by a gate.

It is also possible to block signals via the "Filter function" setting. The following settings are possible: "Filter nothing", "Filter ON" or "Filter OFF". This function is e.g. only necessary if the ON telegram from a sensor is of interest and this sensor does not have a filter function in its application program.

Temperature comparator

The two temperature comparator functions correspond to the functions of the DIN rail mounted logic module.

Temperature comparator 1110

With the function "Temperature comparator 1110", a temperature is compared with an internally defined temperature value. The function makes an input available with a 2-byte communication object. Temperature telegrams which are triggered by an EIB temperature sensor are received at this object and compared.

The value which the temperature at input 1 should be compared with, is defined in the parameter "Comparative value in °C". This comparative value (input 2) can adopt values between -30 °C and +70 °C.

Application example:
Monitoring of a warehouse. Food should be stored in the warehouse at a temperature below 12 °C. An EIB temperature sensor is installed for this purpose. If the storage temperature exceeds 12 °C, a cooling unit is switched on in order to keep the food fresh.

So that telegrams are not triggered continually, if the temperature values for comparison are almost identical, it is advisable to set a hysteresis. By default, this is set at 1.5 K. This means that if the temperature of the comparative value has a value of 12 °C and the temperature at the input exceeds a value of 12 °C, a telegram is not immediately triggered at the output. It is only triggered when it exceeds 12.75 °C. The output is reset when a temperature falls below 11.25 °C.

The output communication object is 1 bit by default. ON or OFF telegrams are sent to this object. It is defined in the parameters when a telegram is sent. Depending on the setting "Telegram will be sent at", telegrams are triggered if an input is greater than another input or if the result changes. A change in the result means that the value of the input has exceeded or fallen below the comparative value.

In addition, it can be set whether an ON telegram or an OFF telegram is sent when the value exceeds or falls below the comparative value.

1-byte values can also be sent to the output object. To do so, the parameter "Object type of the output" must be set to "1 byte". In a similar way to the switch output, different conditions can also be set to determine when a telegram should be sent. The value which is sent is defined with the settings "It will be sent if input > comparative value" or "...if input < comparative value". Values between 0 and 255 can be sent.

The output value is sent cyclically if the setting "Send output cycle" is activated. The cycle time is set by default at 9:59 but can be adapted to a required cycle time.

Temperature comparator 2110

Two temperatures can be compared with this function. There are two separate inputs available with 2-byte communication objects. Temperature telegrams which are triggered by EIB temperature sensors are received at these objects and compared with each other.

Application example:
Summer/wintertime conversion in a ventilation control system. An EIB temperature sensor is installed in the supply air and discharge air ducts. If the incoming temperature is identical to or warmer than the outgoing temperature, it is possible to switch to summer mode.

The output communication object is 1 bit by default. ON or OFF telegrams are sent to this object. It is defined in the parameters when a telegram is sent. Depending on the setting "Telegram will

be sent at", telegrams are triggered if an input is greater than another input or if the result changes. A change in the result means that the value of input 1 has exceeded or fallen below the value of input 2.

In addition, it can be set whether an ON telegram or an OFF telegram is sent when the value of one input exceeds or falls below the value of the other input.

1-byte values can also be sent to the output object. To do so, the parameter "Object type of the output" must be set to "1 byte". In a similar way to the switch output, different conditions can also be set to determine when a telegram should be sent. The value which is sent is defined with the settings "It will be sent if input 1 > input 2" or "...if input 1 < input 2". Values between 0 and 255 can be sent.

The output value is sent cyclically if the setting "Send output cycle" is activated. The cycle time is set by default at 9:59 but can be adapted to a required cycle time.

ABB i-bus® EIB
 ABB Powernet EIB

LEANtouch (monochrome),
 SMARTtouch (monochrome, colour)
 Type: 6x36/30M(-500), 6x36/100x(-500), 6x36/100CB

Functional description: Logical functions (1...8)

Function	Application
Logical function 1	Inactive AND OR NAND NOR Multiplexer Multiplier Gate Temperature comparator 1I1O Temperature comparator 2I1O
Logical function 2	Inactive AND OR NAND NOR Multiplexer Multiplier Gate Temperature comparator 1I1O Temperature comparator 2I1O
...	
Logical function 7	Inactive AND OR NAND NOR Multiplexer Multiplier Gate Temperature comparator 1I1O Temperature comparator 2I1O
Logical function 8	Inactive AND OR NAND NOR Multiplexer Multiplier Gate Temperature comparator 1I1O Temperature comparator 2I1O

Communication objects for 1-bit inputs (AND, OR, NAND and NOR)

No.	Type	Object name	Function
0	1 bit	Output	Send/Receive
1	1 bit	Input 1	Receive
2	1 bit	Input 2	Receive
3	1 bit	Input 3	Receive
4	1 bit	Input 4	Receive

Communication objects for 1-byte inputs (AND, OR, NAND and NOR)

No.	Type	Object name	Function
0	1 bit	Output	Send/Receive
1	1 byte	Input 1	Receive
2	1 byte	Input 2	Receive
3	1 byte	Input 3	Receive
4	1 byte	Input 4	Receive

Communication objects for 1-bit multiplexer

No.	Type	Object name	Function
0	1 bit	Controller	Receive
1	1 bit	Input 1	Receive
2	1 bit	Input 2	Receive
3	1 bit	Output	Send

Communication objects for 1-byte multiplexer

No.	Type	Object name	Function
0	1 bit	Controller	Receive
1	1 byte	Input 1	Receive
2	1 byte	Input 2	Receive
3	1 byte	Output	Send

Communication objects for 2-byte multiplexer

No.	Type	Object name	Function
0	1 bit	Controller	Receive
1	2 byte	Input 1	Receive
2	2 byte	Input 2	Receive
3	2 byte	Output	Send

Communication objects for 1-bit multiplier

No.	Type	Object name	Function
0	1 bit	Input	Receive
1	1 bit	Output 1	Send
2	1 bit	Output 2	Send
3	1 bit	Output 3	Send
4	1 bit	Output 4	Send

Communication objects for 1-byte multiplier

No.	Type	Object name	Function
0	1 bit	Input	Receive
1	1 byte	Output 1	Send
2	1 byte	Output 2	Send
3	1 byte	Output 3	Send
4	1 byte	Output 4	Send

Communication objects for gate function

No.	Type	Object name	Function
0	1 bit	Control input	Receive
1	1 bit	Input	Send/Receive
2	1 bit	Output	Send/Receive

Communication objects for temperature comparator 111O with 1-bit output

No.	Type	Object name	Function
0	2 byte	Input	Receive
1	1 bit	Output	Send

ABB i-bus® EIB
ABB Powernet EIB

LEANtouch (monochrome),
SMARTtouch (monochrome, colour)
Type: 6x36/30M(-500), 6x36/100x(-500), 6x36/100CB

Communication objects for
temperature comparator 111O with
1-byte output

No.	Type	Object name	Function
0	2 byte	Input	Receive
1	1 byte	Output	Send

Communication objects for
temperature comparator 211O with
1-bit output

No.	Type	Object name	Function
0	2 byte	Input 1	Receive
1	2 byte	Input 2	Receive
2	1 bit	Output	Send

Communication objects for
temperature comparator 211O with
1-byte output

No.	Type	Object name	Function
0	2 byte	Input 1	Receive
1	2 byte	Input 2	Receive
2	1 byte	Output	Send

Parameters: AND, OR, NAND and NOR logic functions

The default setting for the values is printed in bold type.

– Used inputs	1 / 2 / 3 / 4
– Type of input	1 Bit / 1 Byte
– Invert inputs	No / Yes
– Behaviour of inputs after reset	Reading Given value
Only for 1 bit:	
– Given value	Off / On
Only for 1 byte:	
– Given value	0
– Type of output	1 Bit / 1 Byte
– Behaviour of the output	Send always At change
– After overwriting of output	Take value Do not take value
– Delay of the output telegram	No / Yes
Only if “Yes” is selected:	
– Time delay	04:59
Only for 1 bit:	
– Output filter	Send only on Send only off Send on and off
Only for 1 byte:	
– Output filter	Send only given value Send only off Send given value and off
– Given value (1...255)	1

Parameters: Multiplexer

The default setting for the values is printed in bold type.

– Object type input/output	1 Bit 1 Byte 2 Byte
----------------------------	----------------------------------

Parameters: Multiplier

The default setting for the values is printed in bold type.

General:	
– Starting conditions	OFF telegram ON telegram
– Telegram delay (s)	01:00
Separate for each output:	
– Object type Output ...	1 Bit / 1 Byte
Only for 1 bit:	
– Display output ...	Off / On
Only for 1 byte:	
– Display output ...	0

Parameters: Gate function

The default setting for the values is printed in bold type.

– Control input	Activate at OFF Activate at ON
– Object type of input and output	1 Bit not assigned
Only for 1 bit:	
– During the blocking	Do not store input signal Store input signal
– Filter function	Filter nothing Filter ON Filter OFF
– Invert output	No / Yes

Parameters: Temperature comparator 1I1O (1 input 1 output)
The default setting for the values is **printed in bold type**.

General:	
- Comparative value (in °C)	18
- Hysteresis	1.5
- Object type of the output	1 Bit / 1 Byte
- Telegram will be sent at	Input is greater than comparative value Input is less than comparative value Output changing
Only for 1 bit:	
- It will be sent if Input > Comparative value	OFF telegram ON telegram
- It will be sent if Input < Comparative value	OFF telegram ON telegram
Only for 1 byte:	
- It will be sent if Input > Comparative value	0
- It will be sent if Input < Comparative value	255
- Send output cycle	No / Yes
Only if "Yes" is selected:	
- Cycle time (mm:ss)	09:59

Parameters: Temperature comparator 2I1O (2 inputs 1 output)
The default setting for the values is **printed in bold type**.

General:	
- Object type of the output	1 Bit / 1 Byte
- Telegram will be sent at	Input 1 is greater than input 2 Input 1 is less than input 2 Output changing
Only for 1 bit:	
- It will be sent if Input 1 > Input 2	OFF telegram ON telegram
- It will be sent if Input 1 < Input 2	OFF telegram ON telegram
Only for 1 byte:	
- It will be sent if Input 1 > Input 2	0
- It will be sent if Input 1 < Input 2	255
- Send output cycle	No / Yes
Only if "Yes" is selected:	
- Cycle time (mm:ss)	09:59