

The switch/dim actuator is intended for installation in a 60 mm flush-type box in accordance with DIN 49073. The fixing is carried out with screws via the fixing jumper.

Electronic ballasts with a 0(1)...10 V control input can be switched and dimmed with the switch/dim actuator FM.

When using a deep branching box, it may not be used as a branching box.

The following application modules can be implemented for local operation:

- *alpha nea*® switch sensors, 1-fold, 2-fold, 4-fold,
- *solo*® switch sensors, 1-fold, 2-fold, 4-fold, 4-fold MF,
- Busch-triton® switch sensor, 1-fold, 3-fold, 5-fold,
- presence detector,
- *alpha nea*® IR interface,
- *solo*® IR interface.

Depending on the application program, it is also possible to send telegrams to other EIB devices.

Technical data

Power supply	- EIB	24 V DC, via the bus line
Outputs	- 1 floating contact	
	- Switching voltage	230 V AC
	- Switching current	10 A
	- Control output	0 ... 10 V
	- Control current	≤ 50 mA
Connections	- EIB	Pins for bus connecting terminal
	- Application module	10-pole socket connector
	- Load circuit	Screw terminals Wire range 1 ... 2.5 mm ²
	- Control cable	Screw terminals Wire range 1 ... 2.5 mm ²
Operating and display elements	- LED and push button	for assignment of the physical address
Type of protection	- IP 20, EN 60 529 with application module	
Ambient temperature range	- Operation	- 5 °C ... 45 °C
Design	- Flush-mounted device	
Housing, colour	- Plastic housing, black	
Mounting	- in deep flush-type box 60 mm Screw fixing using retaining ring	
Dimensions	- Unit	48 x 44 x 33 mm (H x W x D)
	- Retaining ring	71 x 71 mm
Weight	- 0.08 kg	
Certification	- EIB-certified	
CE norm	- in accordance with the EMC guideline and the low voltage guideline	

Application programs in ETS	Number of communication objects	Max. number of group addresses	Max. number of associations
without operating element:			
Switch Dim Logic Status Fixed value /1	8	16	21

Note:

Please take the application programs for the *alpha*, *solo*® and *Busch-triton*® switch sensors from the table on the next page.

Circuit diagram

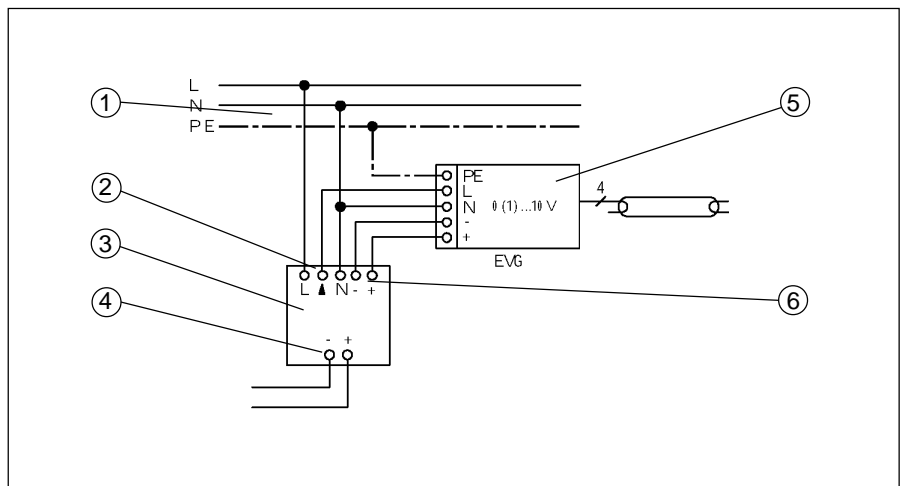

- 1 230 V supply voltage
- 2 230 V supply terminals
- 3 Switch/dim actuator FM
- 4 Bus connecting terminal

- 5 Electronic ballast, 0(1)...10 V
- 6 Terminals for control cable 0(1)...10 V

Application programs in ETS	Number of communication objects	Max. number of group addresses	Max. number of associations
For <i>alpha</i> 1-fold switch sensor: Switch Dim Shutter Flex. Alloc. Logic Status /3	10	16	21
For <i>alpha</i> 2-fold switch sensor: Switch Dim Shutter Flex. Alloc. Logic Status /2	12	16	21
For <i>alpha</i> 4-fold switch sensor: Switch Dim Shutter Flex. Alloc. Logic Status /1	16	16	21
For presence detector: Switch Dim Cyclic HVAC Bright. control /1	12	28	29
For <i>alpha</i> infrared interface: Switch Dim Shutter Logic Status /1	20	20	20
For <i>solo</i>® 1-fold push button: Switch sensor 1f TP/1	15	15	15
For <i>solo</i>® 2-fold push button: Switch sensor 2f TP/1	15	15	15
For <i>solo</i>® 4-fold push button: Switch sensor 4f TP/1	15	15	15
For <i>solo</i>® 4-fold multi function push button: Switch sensor 4f MF TP/1	22	22	22
For <i>solo</i>® 3-fold push button with IR-Receiver: Switch sensor 3f IR TP/1	24	24	24

Note:
The application descriptions for the *solo*® switch sensors in combination with the 1-fold switch actuator/sensor FM (6110 U-101) can be found directly in the descriptions for the individual sensors, in the chapter "Flush-mounted sensors".

Application programs in ETS	Number of communication objects	Max. number of group addresses	Max. number of associations
For 1-fold Busch-triton® switch sensor:			
Switch Dim Shutter Flex. Alloc. Logic Status /4	11	11	23
For 3-fold Busch-triton® switch sensor:			
IR Switch Dim Shutter Lightscene /8	19	19	19
For 3-fold Busch-triton® switch sensor with display:			
IR LCD Switch Dim Shutter Lightscene /4	19	19	19
For 5-fold Busch-triton® switch sensor:			
IR Switch Dim Shutter /1	17	18	18
IR Switch Dim Shutter Lightscene /4	19	19	19
For 5-fold Busch-triton® switch sensor with display:			
IR LCD Switch Dim Shutter /3	19	24	20
IR LCD Switch Dim Shutter Lightscene /3	19	19	21

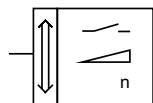
Switch Dim Logic Status Fixed value /1**Selection in ETS2**

- ABB
 - └ Illumination
 - └ Dimmer
- ABB
 - └ FM Dimmer actuator/sensor
 - └ without operating element

The application program is intended for the flush-mounted switch/dim actuator without a further application module.

Switch

The output can be switched on and off via the 1 bit communication object "Dimmer - Switching". The same communication object also sends a telegram if the output changes its state because e.g. the 4 bit object no. 1 "Dimmer" or the 1 byte object no. 2 "Dimmer" has received a telegram.

If the output objects of several switch/dim actuators use the same group addresses, the parameter "Operation mode by paralleling ..." must be taken into account. Only one device may be set to "Master". The other devices must use the "Slave" setting. If this is not observed, the devices may continually send telegrams to each other.

The brightness value, which is used by the switch/dim actuator FM when it is switched on, is defined in the parameters. A constant value between 10% brightness and 100% brightness can be selected. Alternatively, the actuator stores the value of the object "Brightness value" at the point when it was switched off via the switching object and then recreates it.

Dim

The connected luminaire can be dimmed in accordance with EIS 2 with the 4 bit communication object "Dimmer". If the actuator is switched off, it can be dimmed on via the 4 bit object.

The interval for passing through the dimming range can be set with the two parameters "Time base ..." and "Factor ...". The actuator uses the formula

$$\text{Total time} = \text{Base} * \text{Factor}.$$

Using the 1 byte communication object no. 2, the luminaire can be assigned one of 256 brightness values in a range between 0 = switched off and 255 = full brightness. It is defined via the parameter "Behaviour on change in the brightness value" whether the new value is set immediately ("jump to value") or with the selected dimming speed ("dim to value").

Status

If the parameter "Status response" is set to "yes", the ETS2 program displays a further 1 bit object "Status response". As soon as the switch/dim actuator is switched on, regardless of the brightness value, a telegram is sent with the value "1". If the actuator is switched off again, a "0" is sent.

Logic

It is possible to set an AND or OR function with the parameter "Logical connection". In both cases, ETS2 displays an additional communication object. The actuator links the values of objects no. 0 "Switching" and no. 3 "... connection" and then switches the output. Even in this case, the parameter "Status response" enables precise monitoring of the actual output state.

Read-only memory

The actuator has three 1 bit communication objects "Read-only memory ...". It is possible to set up to six values with the two possible object values "0" and "1". The parameters "Value for read-only memory ..." are used for this purpose. The number of read-only memory devices that are actually in use is defined with the parameters "Number of objects" and "Behaviour receiving an OFF telegram".

Bus voltage failure / recovery

On bus voltage failure, the switch/dim actuator FM switches off the connected luminaires. On bus voltage recovery, the luminaires remain switched off in the normal state. It is however also possible to set the minimum or maximum brightness or the last brightness value that was stored prior to the voltage failure.

Communication objects

No.	Type	Object name	Function
0	1 bit	Dimmer	Switching
1	4 bit	Dimmer	Dimming
2	1 byte	Dimmer	Brightness value

Communication objects

for logical connection, status response and read-only memory

No.	Type	Object name	Function
...			
3	1 bit	Dimmer	... connection
4	1 bit	Dimmer	Status response
5	1 bit	Dimmer	Read-only memory A / B
6	1 bit	Dimmer	Read-only memory C / D
7	1 bit	Dimmer	Read-only memory E / F

Parameters

The default setting for the values is **printed in bold type**.

General:	
- Behaviour on change in the brightness value	jump to value dim to value
- Brightness value in event of ON telegram	final value parameterized value
Only if "parameterized value" is selected:	
- Switch ON brightness	10% brightness / 20% brightness / ... / 100% brightness
- Brightness value at bus recovery	OFF max. brightness min. brightness final value
- Operation mode by paralleling some dimmers	Master Slave
Operation modes:	
- Logical connection	no logical connection AND connection OR connection
- Status response	yes no
Dimming characteristic curve:	
- Time base for passing the dimming range	0.5 ms / 8.0 ms / 130 ms / 2.1 s / 33 s
- Factor for passing the dimming range (2 ... 255)	20
For the read-only memory of the outputs:	
- Number of objects	none / 1 / 2 / 3
- Behaviour receiving an ON telegram	set preselected brightness value
Separate for each read-only memory:	
- Value for read-only memory ... (object no. ... = ON)	10% brightness 20% brightness ... 80% brightness 90% brightness 100% brightness
- Behaviour receiving an OFF telegram	set preselected brightness value no reaction
Separate for each read-only memory:	
- Value for read-only memory ... (object no. ... = OFF)	10% brightness 20% brightness 30% brightness 40% brightness ... 90% brightness 100% brightness

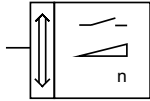
**Switch Dim Shutter Flex. Alloc. Logic
Status /3****Selection in ETS2**

- ABB
 - └ Push Button alpha nea
 - └ Push button, 1-fold for 1SDA

The application program is intended for the 1-fold switch sensor application module in connection with the switch/dim actuator FM.

Note: The descriptions for

- switch,
 - dim,
 - status,
 - logic,
 - read-only memory,
 - bus voltage failure or recovery
- have already been outlined in the application description "Switch Dim Logic Status Fixed value /1".

The functions of the push button are described in the following section.

Switch

If the parameter "Operation mode rocker" is set to "Switching", the ETS2 program displays a further communication object "Push button - Switching". When the upper contact of the push button is pressed, the device sends an "On" telegram while an "Off" telegram is sent on the EIB when the lower contact is pressed.

Dim

In the "Dimming" operating mode, ETS2 displays two communication objects for the push button for dimming.

After a short push button action, the corresponding 1 bit communication object "Push button short - Switching" sends "On" or "Off" telegrams on the EIB.

After a long operation, the push button sends dimming telegrams to the 4 bit object "Push button long - Dimming". When the push button is released, the push button sends the telegram "Stop dimming".

Pressing the upper contact switches on or dims brighter. Pressing the lower contact switches off or dims darker.

Shutter

If "Shutter" is selected as the operating mode, two 1 bit communication objects are available for the push button.

After a long push button action, the corresponding object "Push button long - Move shutter" sends telegrams for shutter movement. The object "Push button short - Adjust lamella of shutter" sends "Louvre adjustment / stop" telegrams after a short push button action.

Pressing the upper push button enables the shutter to be raised i.e. the value "0" is sent. After pressing the lower contact, a "1" is sent and the shutter is lowered.

Flexible allocation

In the operation mode "Flexible allocation", the push button has the two 1 bit communication objects "Upper push button - Switching" and "Lower push button - Switching".

With the parameters "Reaction on upper contact" or "Reaction on lower contact", it is defined when the push button sends "On" or "Off" telegrams.

By default, the push button is toggled after each operation. With the setting "switch defined", it can be freely selected whether a telegram is sent when the push button is pressed (rising) or when it is released (falling). With the setting "no reaction", the push button is switched off.

LED

With the parameter "Operation mode of LED", it can be defined whether the LED displays the value of object no. 8 "Push button ..." or always lights up in the same colour as an orientation light.

Communication objects

No.	Type	Object name	Function
0	1 bit	Dimmer	Switching
1	4 bit	Dimmer	Dimming
2	1 byte	Dimmer	Brightness value
...			
8	1 bit	Push button	Switching

Communication objects

for logical connection, status response and read-only memory

No.	Type	Object name	Function
...			
3	1 bit	Dimmer	... connection
4	1 bit	Dimmer	Status response
5	1 bit	Dimmer	Read-only memory A / B
6	1 bit	Dimmer	Read-only memory C / D
7	1 bit	Dimmer	Read-only memory E / F
...			

Communication objects

for dimming function

No.	Type	Object name	Function
...			
8	1 bit	Push button short	Switching
9	4 bit	Push button long	Dimming

Communication objects

for shutter function

No.	Type	Object name	Function
...			
8	1 bit	Push button short	Move shutter
9	1 bit	Push button long	Adjust lamella of shutter

Communication objects

for push button function

No.	Type	Object name	Function
...			
8	1 bit	Lower push button	Switching
9	1 bit	Upper push button	Switching

Parameters for the switch/dim actuator
The default setting for the values is **printed in bold type**.

General:	
– Behaviour on change in the brightness value	jump to value dim to value
– Brightness value in event of ON telegram	final value parameterized value
Only if “parameterized value” is selected:	
– Switch ON brightness	10% brightness / 20% brightness / ... / 100% brightness
– Brightness value at bus recovery	OFF max. brightness min. brightness final value
– Operation mode by paralleling some dimmers	Master Slave
Operation modes:	
– Logical connection	no logical connection AND connection OR connection
– Status response	yes no
Dimming characteristic curve:	
– Time base for passing the dimming range	0.5 ms / 8.0 ms / 130 ms / 2.1 s / 33 s
– Factor for passing the dimming range (2 ... 255)	20
For the read-only memory of the outputs:	
– Number of objects	none / 1 / 2 / 3
– Behaviour receiving an ON telegram	set preselected brightness value
Separate for each read-only memory:	
– Value for read-only memory ... (object no. ... = ON)	10% brightness 20% brightness ... 80% brightness 90% brightness 100% brightness
– Behaviour receiving an OFF telegram	set preselected brightness value no reaction
Separate for each read-only memory:	
– Value for read-only memory ... (object no. ... = OFF)	10% brightness 20% brightness 30% brightness 40% brightness ... 90% brightness 100% brightness

Parameters for the push button
The default setting for the values is **printed in bold type**.

Push button:	
– Operation mode rocker	Switching Dimming Shutter Flexible allocation
Only if “Flexible allocation” is selected:	
– Reaction on upper contact	TOGGLE switch defined
Only if “switch defined” is selected:	
– Value of object A	no reaction rising = ON rising = OFF falling = ON falling = OFF rising = ON, falling = OFF rising = ON, falling = ON rising = OFF, falling = ON rising = OFF, falling = OFF
– Reaction on lower contact	TOGGLE switch defined
Only if “switch defined” is selected:	
– Value of object B	no reaction rising = ON rising = OFF falling = ON falling = OFF rising = ON, falling = OFF rising = ON, falling = ON rising = OFF, falling = ON rising = OFF, falling = OFF
– Operation mode of LED	shows object value orientation light
Only if “shows object value” is selected:	
– Colour of the LED	OFF = green, ON = red OFF = red, ON = green
Only if “orientation light” is selected:	
– Colour of the LED	always green always red

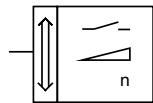
Switch Dim Shutter Flex. Alloc. Logic Status /2**Selection in ETS2**

- ABB
Push Button alpha nea
Push button, 2-fold for 1SDA

The application program is intended for the 2-fold switch sensor application module in connection with the switch/dim actuator FM.

Note: The descriptions for

- switch,
 - dim,
 - status,
 - logic,
 - read-only memory,
 - bus voltage failure or recovery
- have already been outlined in the application description "Switch Dim Logic Status Fixed value /1".

The functions of the push buttons are described in the following section.

Switch

If the parameter "Operation mode rocker" is set to "Switching", the ETS2 program displays two further communication objects "Push button left - Switching" and "Right push button - Switching". When the upper contact of the push button is pressed, the device sends an "On" telegram while an "Off" telegram is sent on the EIB when the lower contact is pressed.

Dim

In the "Dimming" operating mode, ETS2 displays two communication objects for each push button for dimming.

After a short push button action, the corresponding 1 bit communication object "Push button ... short - Switching" sends "On" or "Off" telegrams on the EIB.

After a long operation, the push button sends dimming telegrams to the 4 bit object "Push button ... long - Dimming". When the push button is released, the push button sends the telegram "Stop dimming".

Pressing the upper contact switches on or dims brighter. Pressing the lower contact switches off or dims darker.

Shutter

If "Shutter" is selected as the operating mode, two 1 bit communication objects are available for each push button.

After a long push button action, the corresponding object "Push button ... long - Move shutter" sends telegrams for shutter movement. The object "Push button ... short - Adjust lamella of shutter" sends "Louvre adjustment / stop" telegrams after a short push button action.

Pressing the upper push button enables the shutter to be raised i.e. the value "0" is sent. After pressing the lower contact, a "1" is sent and the shutter is lowered.

Flexible allocation

In the operation mode "Flexible allocation", the push button has the 1 bit communication objects "Left upper push button - Switching", "Left push button lower - Switching", "Right push button upper - Switching" and "Right push button lower - Switching".

With the parameters "Reaction on upper contact" or "Reaction on lower contact", it is defined when the push button sends "On" or "Off" telegrams.

By default, the push button is toggled after each operation. With the setting "switch defined", it can be freely selected whether a telegram is sent when the push button is pressed (rising) or when it is released (falling). With the setting "no reaction", the push button is switched off.

LED

With the parameter "Operation mode of LED", it can be defined whether the LED displays the value of object no. 8/10 "Push button ..." or always lights up in the same colour as an orientation light.

Communication objects

No.	Type	Object name	Function
0	1 bit	Dimmer	Switching
1	4 bit	Dimmer	Dimming
2	1 byte	Dimmer	Brightness value
...			
8	1 bit	Push button left	Switching
10	1 bit	Right push button	Switching

Communication objects
for logical connection, status response
and read-only memory

No.	Type	Object name	Function
...			
3	1 bit	Dimmer	... connection
4	1 bit	Dimmer	Status response
5	1 bit	Dimmer	Read-only memory A / B
6	1 bit	Dimmer	Read-only memory C / D
7	1 bit	Dimmer	Read-only memory E / F
...			

Communication objects
for dimming function

No.	Type	Object name	Function
...			
8	1 bit	Push button left short	Switching
9	4 bit	Push button left long	Dimming
10	1 bit	Push button right short	Switching
11	4 bit	Push button right long	Dimming

Communication objects
for shutter function

No.	Type	Object name	Function
...			
8	1 bit	Push button left short	Move shutter
9	1 bit	Push button left long	Adjust lamella of shutter
10	1 bit	Push button right short	Move shutter
11	1 bit	Push button right long	Adjust lamella of shutter

Communication objects
for push button function

No.	Type	Object name	Function
...			
8	1 bit	Left push button lower	Switching
9	1 bit	Left upper push button	Switching
10	1 bit	Right push button lower	Switching
11	1 bit	Right push button upper	Switching

Parameters for the switch/dim actuator
The default setting for the values is **printed in bold type**.

General:	
– Behaviour on change in the brightness value	jump to value dim to value
– Brightness value in event of ON telegram	final value parameterized value
Only if “parameterized value” is selected:	
– Switch ON brightness	10% brightness / 20% brightness / ... / 100% brightness
– Brightness value at bus recovery	OFF max. brightness min. brightness final value
– Operation mode by paralleling some dimmers	Master Slave
Operation modes:	
– Logical connection	no logical connection AND connection OR connection
– Status response	yes no
Dimming characteristic curve:	
– Time base for passing the dimming range	0.5 ms / 8.0 ms / 130 ms / 2.1 s / 33 s
– Factor for passing the dimming range (2 ... 255)	20
For the read-only memory of the outputs:	
– Number of objects	none / 1 / 2 / 3
– Behaviour receiving an ON telegram	set preselected brightness value
Separate for each read-only memory:	
– Value for read-only memory ... (object no. ... = ON)	10% brightness 20% brightness ... 80% brightness 90% brightness 100% brightness
– Behaviour receiving an OFF telegram	set preselected brightness value no reaction
Separate for each read-only memory:	
– Value for read-only memory ... (object no. ... = OFF)	10% brightness 20% brightness 30% brightness 40% brightness ... 90% brightness 100% brightness

Parameters for the push button
The default setting for the values
is **printed in bold type**.

Separate for each push button:	
– Operation mode rocker	Switching Dimming Shutter Flexible allocation
Only if “Flexible allocation” is selected:	
– Reaction on upper contact	TOGGLE switch defined
Only if “switch defined” is selected:	
– Value of object A	no reaction rising = ON rising = OFF falling = ON falling = OFF rising = ON, falling = OFF rising = ON, falling = ON rising = OFF, falling = ON rising = OFF, falling = OFF
– Reaction on lower contact	TOGGLE switch defined
Only if “switch defined” is selected:	
– Value of object B	no reaction rising = ON rising = OFF falling = ON falling = OFF rising = ON, falling = OFF rising = ON, falling = ON rising = OFF, falling = ON rising = OFF, falling = OFF
– Operation mode of LED	shows object value orientation light
Only if “shows object value” is selected:	
– Colour of the LED	OFF = green, ON = red OFF = red, ON = green
Only if “orientation light” is selected:	
– Colour of the LED	always green always red

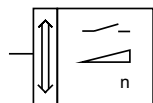
Switch Dim Shutter Flex. Alloc. Logic Status /1**Selection in ETS2**

- ABB
 - └ Push Button alpha nea
 - └ Push button, 4-fold for 1SDA

The application program is intended for the 4-fold switch sensor application module in connection with the switch/dim actuator FM.

Note: The descriptions for

- switch,
 - dim,
 - status,
 - logic,
 - read-only memory,
 - bus voltage failure or recovery
- have already been outlined in the application description "Switch Dim Logic Status Fixed value /1".

The functions of the push buttons are described in the following section.

Switch

If the parameter "Operation mode rocker" is set to "Switching", the ETS2 program displays the communication objects "Push button ... - Switching". When the upper contact of the push button is pressed, the device sends an "On" telegram while an "Off" telegram is sent on the EIB when the lower contact is pressed.

Dim

In the "Dimming" operating mode, ETS2 displays two communication objects for each push button for dimming.

After a short push button action, the corresponding 1 bit communication object "Push button ... short - Switching" sends "On" or "Off" telegrams on the EIB.

After a long operation, the push button sends dimming telegrams to the 4 bit object "Push button ... long - Dimming". When the push button is released, the push button sends the telegram "Stop dimming".

Pressing the upper contact switches on or dims brighter. Pressing the lower contact switches off or dims darker.

Shutter

If "Shutter" is selected as the operating mode, two 1 bit communication objects are available for each push button.

After a long push button action, the corresponding object "Push button ... long - Move shutter" sends telegrams for shutter movement. The object "Push button ... short - Adjust lamella of shutter" sends "Louvre adjustment / stop" telegrams after a short push button action.

Pressing the upper push button enables the shutter to be raised i.e. the value "0" is sent. After pressing the lower contact, a "1" is sent and the shutter is lowered.

Flexible allocation

In the operation mode "Flexible allocation", each push button has two 1 bit communication objects available.

With the parameters "Reaction on upper contact" or "Reaction on lower contact", it is defined when the push button sends "On" or "Off" telegrams.

By default, the push button is toggled after each operation. With the setting "switch defined", it can be freely selected whether a telegram is sent when the push button is pressed (rising) or when it is released (falling). With the setting "no reaction", the push button is switched off.

LED

With the parameter "Operation mode of LED", it can be defined whether the LED displays the value of object no. 8/10/12/14 "Push button ..." or always lights up in the same colour as an orientation light.

Communication objects

No.	Type	Object name	Function
0	1 bit	Dimmer	Switching
1	4 bit	Dimmer	Dimming
2	1 byte	Dimmer	Brightness value
...			
8	1 bit	Push button left	Switching
10	1 bit	Push button left middle	Switching
12	1 bit	Right middle button	Switching
14	1 bit	Right push button	Switching

Communication objects

for logical connection, status response and read-only memory

No.	Type	Object name	Function
...			
3	1 bit	Dimmer	... connection
4	1 bit	Dimmer	Status response
5	1 bit	Dimmer	Read-only memory A / B
6	1 bit	Dimmer	Read-only memory C / D
7	1 bit	Dimmer	Read-only memory E / F
...			

Communication objects

for dimming function

No.	Type	Object name	Function
...			
8	1 bit	Push button left short	Switching
9	4 bit	Push button left long	Dimming
10	1 bit	Push button left middle short	Switching
11	4 bit	Push button left middle long	Dimming
12	1 bit	Push button right middle short	Switching
13	4 bit	Push button right middle long	Dimming
14	1 bit	Push button right short	Switching
15	4 bit	Push button right long	Dimming

Communication objects

for shutter function

No.	Type	Object name	Function
...			
8	1 bit	Push button left long	Move shutter
9	1 bit	Push button left short	Adjust lamella of shutter
10	1 bit	Push button left middle long	Move shutter
11	1 bit	Push button left middle short	Adjust lamella of shutter
12	1 bit	Push button right middle long	Move shutter
13	1 bit	Push button right middle short	Adjust lamella of shutter
14	1 bit	Push button right long	Move shutter
15	1 bit	Push button right short	Adjust lamella of shutter

Communication objects

for push button function

No.	Type	Object name	Function
...			
8	1 bit	Left push button lower	Switching
9	1 bit	Left upper push button	Switching
10	1 bit	Push button left middle lower	Switching
11	1 bit	Push button left middle upper	Switching
12	1 bit	Right middle lower button	Switching
13	1 bit	Right middle upper button	Switching
14	1 bit	Right push button lower	Switching
15	1 bit	Right push button upper	Switching

Parameters for the switch/dim actuator
The default setting for the values is **printed in bold type**.

General:	
– Behaviour on change in the brightness value	jump to value dim to value
– Brightness value in event of ON telegram	final value parameterized value
Only if “parameterized value” is selected:	
– Switch ON brightness	10% brightness / 20% brightness / ... / 100% brightness
– Brightness value at bus recovery	OFF max. brightness min. brightness final value
– Operation mode by paralleling some dimmers	Master Slave
Operation modes:	
– Logical connection	no logical connection AND connection OR connection
– Status response	yes no
Dimming characteristic curve:	
– Time base for passing the dimming range	0.5 ms / 8.0 ms / 130 ms / 2.1 s / 33 s
– Factor for passing the dimming range (2 ... 255)	20
For the read-only memory of the outputs:	
– Number of objects	none / 1 / 2 / 3
– Behaviour receiving an ON telegram	set preselected brightness value
Separate for each read-only memory:	
– Value for read-only memory ... (object no. ... = ON)	10% brightness 20% brightness ... 80% brightness 90% brightness 100% brightness
– Behaviour receiving an OFF telegram	set preselected brightness value no reaction
Separate for each read-only memory:	
– Value for read-only memory ... (object no. ... = OFF)	10% brightness 20% brightness 30% brightness 40% brightness ... 90% brightness 100% brightness

Parameters for the push button
 The default setting for the values
 is **printed in bold type**.

Separate for each push button:	
– Operation mode rocker	Switching Dimming Shutter Flexible allocation
Only if “Flexible allocation” is selected:	
– Reaction on upper contact	TOGGLE switch defined
Only if “switch defined” is selected:	
– Value of object A	no reaction rising = ON rising = OFF falling = ON falling = OFF rising = ON, falling = OFF rising = ON, falling = ON rising = OFF, falling = ON rising = OFF, falling = OFF
– Reaction on lower contact	TOGGLE switch defined
Only if “switch defined” is selected:	
– Value of object B	no reaction rising = ON rising = OFF falling = ON falling = OFF rising = ON, falling = OFF rising = ON, falling = ON rising = OFF, falling = ON rising = OFF, falling = OFF
– Operation mode of LED	shows object value orientation light
Only if “shows object value” is selected:	
– Colour of the LED	OFF = green, ON = red OFF = red, ON = green
Only if “orientation light” is selected:	
– Colour of the LED	always green always red

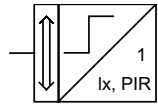
Switch Dim Cyclic HVAC Bright. control /1**Selection in ETS2**

- ABB
 - └ Phys. Sensors
 - └ Presence detector

The application program is intended for the presence detector in connection with the switch/dim actuator FM.

Note: The descriptions for

- switch,
- value,
- cyclic,
- setting of the channels,
- brightness-dependent switching,
- light source,
- HVAC

and monitoring have already been outlined in the application description "Switch Value Cyclic HVAC Monitoring" for the presence detector.

The function of the switch/dim actuator and the constant brightness controller are described in the following section.

Switch/dim actuator

The output can be switched on and off via the 1 bit communication object "Output - Switching". The same communication object also sends a telegram if the output modifies its state because e.g. the 4 bit object "Dimmer - Rel. dimming" or the 1 byte object "Dimmer - Brightness value" has received a telegram. The transmit flag must be set however.

The brightness value which the switch/dim actuator uses when switching on is defined in the parameters. If required, it is possible to send a select a constant value between 10% brightness and 100% brightness.

With the 4 bit communication object "Dimmer - Rel. dimming", the connected luminaires can be dimmed in accordance with EIS 2. If the actuator is switched off, it can be dimmed on via the 4 bit object.

With the 1 byte communication object "Dimmer - Brightness value", one of 256 brightness values in a range between 0 = switched off and 255 = full brightness can be given to the connected luminaire. The object can also forward a modified brightness value to other dimmers. To do so, the transmit flag must be set. The setting "internal and external dimmer" sets the transmit flag automatically.

Constant brightness

The constant brightness controller can influence one or several dimming actuators. If only the switch/dim actuator FM, which is placed on the presence detector, is used to control the brightness level, the setting "internal dimmer" should be selected as the "Type of dimming actuator". If several dimming actuators control the brightness in the room, the selection should be modified to "internal and external dimmer". In the latter setting, the current brightness value is sent via the communication object "Dimmer - Brightness value". It should be ensured that the dimming actuators that are used in this case have entered the same group address for the brightness object. The dimming actuators must be operated in slave mode. The setting is carried out via the respective dimmer application.

To avoid fluctuations in the brightness level, the presence detector should record the exact area that is illuminated by the luminaires which are controlled by the switch/dim actuator FM.

The constant brightness controller can be activated or deactivated at any time via the EIB. The object "Constant brightness controller - Activation" is used for this purpose. If a telegram with the value "1" is received at this object, the constant brightness controller is switched on. The controller is switched off when a telegram with the value "0" is sent to the object.

If the constant brightness controller should be switched on directly e.g. on detection of movement, the objects "Movement - Telegr. switch" and "Constant brightness controller - Activation" should be linked together via a common group address.

The switch/dim actuator is switched on via the 1 bit object "Output - Switching". The initial brightness value can be set. By default, the actuator switches on with 50% brightness.

The parameter "Speed of control" specifies the period that the controller requires to pass through the complete dimming range. A constant level of brightness is more pleasing to the human eye. Rapid variations in the brightness level are disruptive.

It is advisable during normal operation to leave the speed in the default setting of "normal".

The value for the constant brightness controller can be selected with the Lux1 potentiometer of the presence detector or via the ETS software. If the setpoint adjustment is carried out via ETS, it is possible to enter a setpoint for the constant brightness controller directly. This can be a brightness value between 5 and 1000 lux. It is however a better idea to let the user set the required brightness value directly. To do so, the ETS2 program enables the communication object "Constant brightness controller - Save act. brightness value". As soon as a telegram with the value "1" is received at this object, the presence detector adopts the current brightness value as the new setpoint for the constant brightness controller.

A new setpoint for the constant brightness controller can be assigned at any time via the 1 byte communication object "Constant brightness controller - Brightness setpoint/act. value" (see example).

If the user leaves the room, the presence detector starts its normal recovery time which can be set on the tab "Adjustments channel 1". However, if the user has previously adapted the brightness value to his requirements via the dimming objects, the presence detector starts the recovery time for an inactive constant brightness controller, once the normal recovery time has elapsed. This means that if someone enters the room during this period, the combined presence detector and switch/dim actuator will not directly start the constant brightness controller. The switch/dim actuator will switch on with the last active brightness value.

The presence detector can switch on or disable the constant brightness controller mode directly after bus voltage recovery. There is a corresponding option on the "General" page.

The current "Brightness setpoint/act. value" is not stored after a bus voltage failure. If a specific brightness value should be set after bus voltage recovery, it should be sent again to the object "Constant brightness controller - Brightness setpoint/act. value".

Example:

A constant brightness controller should be used in a sports hall for energy saving. In leisure mode, the lighting should be regulated to a brightness level of 200 lux while in competition mode the brightness should be regulated to 500 lux.

The presence detector is used together with the switch/dim actuator FM and a 1-fold switch sensor (application "Value") to toggle the two types of constant brightness control.

The combined presence detector and switch/dim actuator must be installed in a suitable position and put into operation. After the commissioning stage, the illuminance should be determined with a measuring device. The current brightness value of the actuator can be modified via the dimming objects until an illuminance of 200 lux is achieved.

The communication object "Constant brightness controller - Brightness setpoint/act. value" must then be read out with the help of ETS2. To do so, select "Groups" from the "Test" menu and enter the group address in the "Read value" tab which has been entered in the communication object above. You should then either write down the value which is sent in the response or store it directly in the parameter window of the 1-fold switch sensor.

Dim the actuator up again until a value of 500 lux is reached. You should again send a read request to the object "Constant brightness controller - Brightness setpoint/act. value". Write down the value of the response telegram again or enter it directly in the parameters of the 1-fold switch sensor.

If you have not already done so, enter the two recorded values in the parameter window of the 1-fold switch sensor. When selecting the application of the switch sensor, it should be ensured that the rockers can send 1 byte values.

Put the switch sensor into operation and constant brightness control is implemented with the toggling of two operating modes.

Additional **communication objects**
for switch/dim actuator FM

No.	Type	Object name	Function
...			
6	1 bit	Output	Switching
7	4 bit	Dimmer	Rel. dimming
8	1 byte	Dimmer	Brightness value
9	1 bit	Constant brightness controller	Activation
11	1 byte	Constant brightness controller	Brightness setpoint/act. value

Communication objects
with object for storing the current
brightness value

No.	Type	Object name	Function
...			
10	1 bit	Constant brightness controller	Save act. brightness value
...			

Parameters for "Low Access"
The default setting for the values
is **printed in bold type**.

Constant brightness controller with "Low Access":	
- Type of dimming actuator	internal and external dimmer internal dimmer
- Activation object constant brightness control	not available available
Only if activation object is available:	
- enabling constant brightness control at	ON telegram OFF telegram
- Switch ON brightness	10% brightness / ... / 50% brightness / ... / 100% brightness
- Speed of control	Test mode (8.2ms*30) fast (8.2ms*50) normal (130ms*7) slow(130ms*14)
General:	
Behaviour on bus voltage recovery (communication objects)	
- Constant brightness controller	disabled enabled

Parameters for "High Access"
The default setting for the values
is **printed in bold type**.

Additional parameters for "High Access":	
- Setpoint adjustable with	ETS Lux1 potentiometer
Only if "ETS" is selected:	
- Setpoint brightness control (5 lux ... 1000 lux)	5
- Recovery time of inactive constant brightness controller is adjusted by	ETS illumination potentiometer
Only if "ETS" is selected:	
- Time base of recovery time	0.5 ms / 8.2 ms / 130 ms / 2.1 s / 34 s / 9 min
- Time factor of recovery time	100

ABB i-bus® EIB

Switch/dim actuator, FM
Type: 6114 U-500 + 6131-74-101

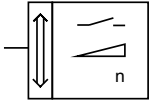
Switch Dim Shutter Logic Status /1**Selection in ETS2**

- ABB
 - └ Push Button alpha nea
 - └ Push button, 1-fold for 1SDA

The application program is intended for the infrared interface application module in connection with the switch/dim actuator FM.

Note: The descriptions for

- switch,
 - dim,
 - status,
 - logic,
 - read-only memory,
 - bus voltage failure or recovery
- have already been outlined in the application description "Switch Dim Logic Status Fixed value /1".

The functions of the rocker pair for IR remote control or the local push button are described in the following section.

Switch

If the parameter "Operation mode rocker" of one rocker pair or the local push button is set to "Switching", the ETS2 program displays a communication object "Rocker pair ... - Switching". If a rocker pair is pressed, the corresponding communication object sends switching telegrams.

Dim

In the "Dimming" operating mode, ETS2 displays two communication objects for the rocker pairs for dimming.

After a short push button action, the corresponding 1 bit communication object "Rocker pair ... short - Switching" sends "On" or "Off" telegrams on the EIB.

After a long push button action, dimming telegrams are sent to the 4 bit object "Rocker pair ... long - Dimming". When a rocker pair is released, a "Stop dimming" telegram is sent.

Shutter

If "Shutter" is selected as the operating mode, two 1 bit communication objects are available for the rocker pair.

After a long push button action, the corresponding object "Rocker pair ... long - Move shutter" sends telegrams for shutter movement. The object "Rocker pair ... short - Adjust lamella of shutter" sends "Louvre adjustment / stop" telegrams after a short push button action.

Communication objects

No.	Type	Object name	Function
0	1 bit	Dimmer	Switching
1	4 bit	Dimmer	Dimming
2	1 byte	Dimmer	Brightness value
...			
8	1 bit	Rocker pair 1	Switching
10	1 bit	Rocker pair 2	Switching
12	1 bit	Rocker pair 3	Switching
14	1 bit	Rocker pair 4	Switching
16	1 bit	Rocker pair 5	Switching
18	1 bit	Push button local	Switching

Communication objects

for logical connection, status response and read-only memory

No.	Type	Object name	Function
...			
3	1 bit	Dimmer	... connection
4	1 bit	Dimmer	Status response
5	1 bit	Dimmer	Read-only memory A / B
6	1 bit	Dimmer	Read-only memory C / D
7	1 bit	Dimmer	Read-only memory E / F
...			

Communication objects

for dimming function

No.	Type	Object name	Function
...			
8	1 bit	Rocker pair 1 short	Switching
9	4 bit	Rocker pair 1 long	Dimming
10	1 bit	Rocker pair 2 short	Switching
11	4 bit	Rocker pair 2 long	Dimming
12	1 bit	Rocker pair 3 short	Switching
13	4 bit	Rocker pair 3 long	Dimming
14	1 bit	Rocker pair 4 short	Switching
15	4 bit	Rocker pair 4 long	Dimming
16	1 bit	Rocker pair 5 short	Switching
17	4 bit	Rocker pair 5 long	Dimming
18	1 bit	Push button local short	Switching
19	4 bit	Push button local long	Dimming

Communication objects

for shutter function

No.	Type	Object name	Function
...			
8	1 bit	Rocker pair 1 short	Move shutter
9	1 bit	Rocker pair 1 long	Adjust lamella of shutter
10	1 bit	Rocker pair 2 short	Move shutter
11	1 bit	Rocker pair 2 long	Adjust lamella of shutter
12	1 bit	Rocker pair 3 short	Move shutter
13	1 bit	Rocker pair 3 long	Adjust lamella of shutter
14	1 bit	Rocker pair 4 short	Move shutter
15	1 bit	Rocker pair 4 long	Adjust lamella of shutter
16	1 bit	Rocker pair 5 short	Move shutter
17	1 bit	Rocker pair 5 long	Adjust lamella of shutter
18	1 bit	Push button local short	Move shutter
19	1 bit	Push button local long	Adjust lamella of shutter

Parameters for the switch/dim actuator
The default setting for the values is **printed in bold type**.

General:	
– Brightness value in event of ON telegram	final value parameterized value
Only if “parameterized value” is selected:	
– Switch ON brightness	10% brightness / 20% brightness / ... / 100% brightness
– Brightness value at bus recovery	OFF max. brightness min. brightness final value
– Operation mode by paralleling some dimmers	Master Slave
Operation modes:	
– Logical connection	no logical connection AND connection OR connection
– Status response	yes no
Dimming characteristic curve:	
– Time base for passing the dimming range	0.5 ms / 8.0 ms / 130 ms / 2.1 s / 33 s
– Factor for passing the dimming range (2 ... 255)	20
For the read-only memory of the outputs:	
– Number of objects	none / 1 / 2 / 3
– Behaviour receiving an ON telegram	set preselected brightness value
Separate for each read-only memory:	
– Value for read-only memory ... (object no.. ... = ON)	10% brightness 20% brightness ... 80% brightness 90% brightness 100% brightness
– Behaviour receiving an OFF telegram	preselected brightness value no reaction
Separate for each read-only memory:	
– Value for read-only memory ... (object no. ... = OFF)	10% brightness 20% brightness 30% brightness 40% brightness ... 90% brightness 100% brightness
Separate for each rocker pair:	
– Operation mode rocker	Switching Dimming Shutter

Parameters for the push button
The default setting for the values is **printed in bold type**.

ABB i-bus® EIB

Switch/dim actuator, FM
Type: 6114 U-500 + 6135-2x

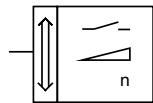
**Switch Dim Shutter Flex. Alloc. Logic
Status /4****Selection in ETS2**

- ABB
 - └ Push Button triton
 - └ Push button, 1-fold for 1SDA

The application program is intended for the 1-fold Busch-triton® switch sensor application module in connection with the switch/dim actuator FM.

Note: The descriptions for

- switch,
- dim,
- status,
- logic,
- read-only memory,
- bus voltage failure or recovery

have already been outlined in the application description "Switch Dim Logic Status Fixed value /1".

The functions of the push button are described in the following section.

Switch

If the parameter "Operation mode rocker" is set to "Switching", the ETS2 program displays a communication object "Push button - Switching". The device sends an "On" telegram when any contact of the push button is pressed while an "Off" telegram is sent on the EIB when the push button is pressed again.

Dim

In the "Dimming" operating mode, ETS2 displays two communication objects for the push button for dimming.

After a short push button action, the corresponding 1 bit communication object "Push button short - Switching" sends "On" or "Off" telegrams on the EIB.

After a long operation, the push button sends dimming telegrams to the 4 bit object "Push button long - Dimming". When the push button is released, the push button sends the telegram "Stop dimming".

Pressing the left push button triggers "Dimming brighter" telegrams while pressing the right push button sends "Dimming darker" telegrams.

Shutter

If "Shutter" is selected as the operating mode, two 1 bit communication objects are available for the push button.

After a long push button action, the corresponding object "Push button long - Move shutter" sends telegrams for shutter movement. The object "Push button short - Adjust lamella of shutter" sends "Louvre adjustment / stop" telegrams after a short push button action.

Pressing the left push button enables the shutter to be raised i.e. the value "0" is sent. After pressing the right push button, a "1" is sent and the shutter is lowered.

Flexible allocation

In the operating mode "Flexible allocation", the push button has the two 1 bit communication objects "Push button left - Switching" and "Right push button - Switching".

With the parameters "Reaction on contact left" and "Reaction on contact right", it is defined when the push button sends "On" or "Off" telegrams.

By default, the push button is toggled after each operation. With the setting "switch defined", it can be freely selected whether a telegram is sent when the push button is pressed (rising) or released (falling). In the setting "no reaction", the push button is switched off.

Backlighting/LED

With the parameter "Operation mode of LED", it can be defined whether the LED displays the value of object no. 8 "Push button ..." or always lights up in the same colour as an orientation light.

The backlighting for the text field can be switched on or off via the communication object "Backlighting/LED - Switching". It is possible to permanently enable or disable the backlighting via the parameter "Backlighting".

Communication objects

No.	Type	Object name	Function
0	1 bit	Dimmer	Switching
1	4 bit	Dimmer	Dimming
2	1 byte	Dimmer	Brightness value
...			
8	1 bit	Push button	Switching
10	1 bit	Backlighting/LED	Switching

Communication objects
for logical connection, status response
and read-only memory

No.	Type	Object name	Function
...			
3	1 bit	Dimmer	... connection
4	1 bit	Dimmer	Status response
5	1 bit	Dimmer	Read-only memory A / B
6	1 bit	Dimmer	Read-only memory C / D
7	1 bit	Dimmer	Read-only memory E / F
...			

Communication objects
for dimming function

No.	Type	Object name	Function
...			
8	1 bit	Push button short	Switching
9	4 bit	Push button long	Dimming
10	1 bit	Backlighting/LED	Switching

Communication objects
for shutter function

No.	Type	Object name	Function
...			
8	1 bit	Push button short	Move shutter
9	1 bit	Push button long	Adjust lamella of shutter
10	1 bit	Backlighting/LED	Switching

Communication objects
for push button function

No.	Type	Object name	Function
...			
8	1 bit	Push button left	Switching
9	1 bit	Right push button	Switching
10	1 bit	Backlighting/LED	Switching

Parameters for the switch/dim actuator
The default setting for the values is **printed in bold type**.

General:	
– Behaviour on change in the brightness value	jump to value dim to value
– Brightness value in event of ON telegram	final value parameterized value
Only if "parameterized value" is selected:	
– Switch ON brightness	10% brightness / 20% brightness / ... / 100% brightness
– Brightness value at bus recovery	OFF max. brightness min. brightness final value
– Operation mode by paralleling some dimmers	Master Slave
Operation modes:	
– Logical connection	no logical connection AND connection OR connection
– Status response	yes no
Dimming characteristic curve:	
– Time base for passing the dimming range	0.5 ms / 8.0 ms / 130 ms / 2.1 s / 33 s
– Factor for passing the dimming range (2 ... 255)	20
For the read-only memory of the outputs:	
– Number of objects	none / 1 / 2 / 3
– Behaviour receiving an ON telegram	set preselected brightness value
Separate for each read-only memory:	
– Value for read-only memory ... (object no. ... = ON)	10% brightness 20% brightness ... 80% brightness 90% brightness 100% brightness
– Behaviour receiving an OFF telegram	set preselected brightness value no reaction
Separate for each read-only memory:	
– Value for read-only memory ... (object no. ... = OFF)	10% brightness 20% brightness 30% brightness 40% brightness ... 90% brightness 100% brightness

Parameters for the push button
The default setting for the values is **printed in bold type**.

Push button:	
– Operation mode rocker	Switching Dimming Shutter Flexible allocation
Only if “Flexible allocation” is selected:	
– Reaction on contact left	TOGGLE switch defined
Only if “switch defined” is selected:	
– Value of object A	no reaction rising = ON rising = OFF falling = ON falling = OFF rising = ON, falling = OFF rising = ON, falling = ON rising = OFF, falling = ON rising = OFF, falling = OFF
– Reaction on contact right	TOGGLE switch defined
Only if “switch defined” is selected:	
– Value of object B	no reaction rising = ON rising = OFF falling = ON falling = OFF rising = ON, falling = OFF rising = ON, falling = ON rising = OFF, falling = ON rising = OFF, falling = OFF
– Operation mode of LED	shows object value orientation light
Only if “shows object value” is selected:	
– Colour of the LED	OFF = green, ON = red OFF = red, ON = green
Only if “orientation light” is selected:	
– Colour of the LED	always off always green always red
– Backlighting	Backlighting always off Backlighting always on shows object value
Only if “shows object value” is selected:	
– Backlighting object	OFF = dark, ON = yellow OFF = yellow, ON = dark

IR Switch Dim Lightscene /8

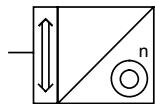

Selection in ETS2

- ABB
 - ↳ Push Button triton
 - ↳ Push button, 3-fold for 1SDA

The application program is intended for the 3-fold Busch-triton® switch sensor application module in connection with the switch/dim actuator FM.

The Busch-triton® switch sensor can be used for switching, dimming and shutter control as well as for controlling lightscenes. Various parameters and communication objects can be used for the rockers depending on the setting selected in the parameters “Number of lightscenes” and “Lightscenes are available on”.

If the rockers of the Busch-triton® switch sensor are not used for lightscene control, they each have the same set of parameters. With the parameter “Operation mode of rocker”, the basic switching, dimming and shutter control functions can be selected. Depending on this setting, different parameters and objects are available for the rockers. There is a common parameter “Push button action interpreted as long from” for all the rockers that are used for dimming or shutter control. Normally, the switch sensor detects a long push button action if a rocker is pressed for longer than 420 ms.

Backlighting

The backlit text fields display the functions of the rockers even in the dark. Using the communication object “Backlighting/LED”, the backlighting and status LEDs can be switched on or off if required.

The auxiliary push button can also be used for manual switching. To do so, the parameter “Function of auxiliary push button” must be set to “Backlighting and LED on/off”. When the auxiliary push button is pressed, not only is the lighting of the switch sensor switched on or off but a telegram is sent via the communication object “Backlighting/LED”. It is therefore possible to switch on the lighting for several Busch-triton® switch sensors at the same time via a common group address.

By default, the backlighting switches on after bus voltage recovery. This can also be changed via the parameter “Behaviour of backlighting at bus recovery”.

Fault protection

The auxiliary push button also makes the fault protection function available. The fault protection function causes only one basic function to be triggered when any of the rockers of the switch sensor are pressed. For example, pressing one of the three rockers via communication object no. 1 “Fault protection” switches the base lighting alternately on or off.

The fault protection function can be permanently activated or for example be timed to switch on or off via the EIB using object no. 0 “Fault protection Off/On”. If the parameter “Function of auxiliary push button” is set to “Interrupt fault protection”, the rockers can be used for different functions according to their parameter settings after pressing the auxiliary push button for approx. 5 seconds.

Dimmer output

The dimmer output has the three communication objects “Switching”, “Rel. dimming” and “Brightness value”. It can thus also be controlled by other sensors via the EIB. If a rocker of the Busch-triton® switch sensor is parameterised as a dimming sensor and the communication objects of the rocker are linked with those of the dimming actuator via a group address, the actuator can also be operated locally.

On receipt of an “On” telegram at the 1 bit communication object, the actuator can switch on with various brightness values. The values can be predefined with the parameter “Switch ON with”.

If the switch sensor is dimmed up from the OFF state or switched on with a brightness value, it sends its new status on the EIB in the basic setting. The signal is carried out at the switching and brightness value objects. This function is required for example to switch on status LEDs or to indicate the current brightness value of the dimming actuator on LCDs.

If the parameter “Status response to...” is set to “no”, this function can also be switched off.

Using the parameters "Time base ..." and "Factor for dimming range", it is possible to set the period which the dimming actuator requires to dim up or down fully once.

IR

In addition to using the rockers, the Busch-triton® switch sensor can also be controlled remotely via an infrared hand-held transmitter. The rockers and the auxiliary push button can be assigned to the white or blue infrared area of the hand-held transmitter. The relevant setting must then be selected via the slide switch on the transmitter. The MEMO button of the transmitter corresponds to the function of the auxiliary push button of the Busch-triton® switch sensor.

Switch

In the default setting of the Busch-triton® switch sensor, there is a 1 bit communication object available for switching for each of the rockers that are not assigned lightscenes. For special applications, the parameter "Number of switch functions" can be set so that each rocker has two communication objects.

The parameter "Working mode of the rocker" determines which value the switch sensor sends when the left or the right side of the rocker is pressed.

Dim

If the operation mode of the rocker is set to "Dimming sensor", the rocker has the communication objects "Rocker ... -short" for switching and "Rocker ... -long" for dimming.

When carrying out a switching operation, the rocker can either be pressed briefly on the left, on the right or in the middle. The switch sensor always toggles in this case.

For dimming, it is determined via the parameter "Dimming direction" which side of the rocker must be pressed and held down in order to dim up or down. When the rocker is released, the switch sensor sends the telegram "Stop dimming".

Shutter

If the operating mode of the rocker is set to "Shutter sensor", the switch sensor sends "Move shutter up/down" telegrams when the left or right side of the rocker is pressed for a long period. After a short operation anywhere on the rocker, it sends telegrams for stopping the shutter movement or for stepwise louvre adjustment.

The parameter "Shutter direction" determines which side of the rocker must be pressed in order to move upwards or downwards.

LED

Using the parameter "Operation mode of LED", the LEDs can be selected for use either as an orientation light or for status display.

In the case of LEDs that are used for status display, it is possible to set which colour (red or green) is assigned to the object values "0" or "1".

The LEDs that are used as an orientation light can either always light up red or always green or they can be switched off.

Lightscenes

In lightscene mode, up to six scenes with up to six different groups of actuators can be controlled without special lightscene modules.

The lightscenes can be specified via the device parameters. The user can then reconfigure the parameters individually according to his requirements while the installation is in operation. The auxiliary push button is used for storing new lightscenes (parameters). To do this, the parameter "Function of auxiliary push button" must be set to "Save lightscenes". To be able to use this function, the transmitting group addresses and flags must be assigned correctly when configuring the actuators.

The lightscenes are configured according to the following process.

1. The number of lightscenes and their respective rocker assignment can be set on the "General" parameter page.
2. For each of the actuator groups A ... F, it must be determined with the parameter "Type of actuator group ...", whether they use 1 bit communication objects (switch or shutter actuators) or 8 bit communication objects (dimming actuators). Depending on this setting, the ETS2 program displays various parameters and communication objects. Communication objects 13 ... 18 are used for the control of actuator groups A ... F.
3. For each of the lightscenes, values can be preset for the actuator groups on their own parameter page.
4. The rockers that are not used for lightscenes are still available for switching, dimming or shutter control. The parameter value "no function" must be selected for unassigned rockers.

If a rocker is used for recalling lightscenes, the LED indicates which side of the rocker has been pressed. It glows red when the left side is pressed and glows green when the right side is pressed. If several rockers are used, the LED of the rocker which was last pressed lights up.

Application example:

Dimmable ceiling lamps are installed in a hotel room. There is also a dimmable reading light by the bed. The light in the adjoining bathroom can also be dimmed.

From the door, it should be possible to control the dimmable ceiling lamps in the lounge/sleeping area and the bathroom light separately. Two lightscenes should be recalled via one push button action:

1. Switch all the lights to maximum brightness for cleaning the room.
2. Switch off all the lights when leaving the room.

From the bed, it should be possible to control the dimmable ceiling lamps and the reading light separately. Two lightscenes should be recalled via one push button action:

1. Dim the ceiling lamps to semi-brightness to light the way during the night and switch on the bathroom light.
2. Switch off all the lights for sleeping.

Two 3-fold Busch-triton® switch sensors, each with a dimming actuator/sensor FM and a switch/dim actuator are used. The output of the dimming actuator/sensor at the door controls the bathroom light. The output of the dimming actuator/sensor at the bed controls the reading light.

Switch/dim actuator, FM
Type: 6114 U-500 + 6322-xx-101

The Busch-triton® switch sensor at the door has the following parameter settings:

Number of lightscenes:
2
Lightscenes are available on:
Rocker 1
Function of auxiliary push button:
no function
Operation mode of rocker 1:
Rocker is assigned to two lightscenes
Operation mode of rocker 2:
Dimming sensor
Operation mode of rocker 3:
Dimming sensor
Rocker is assigned to IR push button:
no IR
Type of actuator group A:
Dimming actuator (8 bit)
Type of actuator group B:
Switch or shutter actuator (1 bit)
Type of actuator group C:
Switch or shutter actuator (1 bit)

The two lightscenes are defined as follows:

Lightscene 1: Base lighting
Actuator group A: 100%,
Actuator group B: ON,
Actuator group C: ON
Lightscene 2: OFF
Actuator group A: 0%,
Actuator group B: OFF,
Actuator group C: OFF

The Busch-triton® switch sensor at the bed has the following parameter settings:

Number of lightscenes:
2
Lightscenes are available on:
Rocker 1
Function of auxiliary push button:
no function
Operation mode of rocker 1:
Rocker is assigned to two lightscenes
Operation mode of rocker 2:
Dimming sensor
Operation mode of rocker 3:
Dimming sensor
Rocker is assigned to IR push button:
no IR
Type of actuator group A:
Dimming actuator (8 bit)
Type of actuator group B:
Switch or shutter actuator (1 bit)
Type of actuator group C:
Switch or shutter actuator (1 bit)

The two lightscenes are defined as follows:

Lightscene 1: Passageway lighting
Actuator group A: 50%,
Actuator group B: ON,
Actuator group C: OFF
Lightscene 2: OFF
Actuator group A: 0%,
Actuator group B: OFF,
Actuator group C: OFF

The links between the communication objects are similar for both switch sensors.

The 1 bit and 4 bit communication objects of rocker 2 are linked to the corresponding objects of the dimming actuator.

The transmit flag is set for the switching object of the dimming actuator. The status LEDs can also be controlled when retrieving lightscenes. It should be ensured that the parameter "Status response to switching object" is set to "yes".

The 1 byte communication object of actuator group A is linked to the 1 byte object of the dimming actuator. The 1 bit communication object of actuator group B is linked to the switching object of the same dimming actuator/sensor. The 1 bit communication object of actuator group C is linked to the switching object of the other dimming actuator/sensor.

In this case, the auxiliary push buttons are not used for saving lightscenes so that a hotel guest does not inadvertently modify the set lightscenes.

Communication objects

No.	Type	Object name	Function
7	1 bit	Dimmer	Switching
8	1 bit	Dimmer	Rel. dimming
9	1 bit	Dimmer	Brightness value
10	1 bit	Backlighting/LED	Switching
13	1 bit	Rocker 1 left	Telegr. switch
14	1 bit	Rocker 1 right	Telegr. switch
15	1 bit	Rocker 2 left	Telegr. switch
16	1 bit	Rocker 2 right	Telegr. switch
17	1 bit	Rocker 3 left	Telegr. switch
18	1 bit	Rocker 3 right	Telegr. switch

Communication objects with fault protection

No.	Type	Object name	Function
0	1 bit	Fault protection Off/On	Input telegr.
1	1 bit	Fault protection	Telegr. switch

...

Communication objects for switch sensor with one function

No.	Type	Object name	Function
...			
13	1 bit	Rocker 1	Telegr. switch
15	1 bit	Rocker 2	Telegr. switch
17	1 bit	Rocker 3	Telegr. switch

Communication objects with 2 lightscenes on rocker 1

No.	Type	Object name	Function
5	1 bit	Dimmer	Switching
6	1 bit	Dimmer	Rel. dimming
7	1 bit	Dimmer	Brightness value
8	1 bit	Backlighting/LED	Switching
9	1 bit	Rocker 2 left	Telegr. switch
10	1 bit	Rocker 2 right	Telegr. switch
11	1 bit	Rocker 3 left	Telegr. switch
12	1 bit	Rocker 3 right	Telegr. switch
13	1 bit	Actuator group A	Telegr. switch
14	1 bit	Actuator group B	Telegr. switch
15	1 bit	Actuator group C	Telegr. switch
16	1 bit	Actuator group D	Telegr. switch
17	1 bit	Actuator group E	Telegr. switch
18	1 bit	Actuator group F	Telegr. switch

Communication objects for rockers with shutter sensor

No.	Type	Object name	Function
...			
13	1 bit	Rocker 1 -long	Telegr. Move up/down
14	1 bit	Rocker 1 -short	Telegr. lamella adj./stop
15	1 bit	Rocker 2 -long	Telegr. Move up/down
16	1 bit	Rocker 2 -short	Telegr. lamella adj./stop
17	1 bit	Rocker 3 -long	Telegr. Move up/down
18	1 bit	Rocker 3 -short	Telegr. lamella adj./stop

Communication objects for rockers with dimming sensor

No.	Type	Object name	Function
...			
13	1 bit	Rocker 1 -short	Telegr. switch
14	1 bit	Rocker 1 -long	Telegr. dimming
15	1 bit	Rocker 2 -short	Telegr. switch
16	1 bit	Rocker 2 -long	Telegr. dimming
17	1 bit	Rocker 3 -short	Telegr. switch
18	1 bit	Rocker 3 -long	Telegr. dimming

Communication objects
 for lightscene control
 with switch actuators

No.	Type	Object name	Function
...			
13	1 bit	Actuator group A	Telegr. switch
14	1 bit	Actuator group B	Telegr. switch
15	1 bit	Actuator group C	Telegr. switch
16	1 bit	Actuator group D	Telegr. switch
17	1 bit	Actuator group E	Telegr. switch
18	1 bit	Actuator group F	Telegr. switch

Communication objects
 for lightscene control
 with dimming actuators

No.	Type	Object name	Function
...			
13	1 byte	Actuator group A	Telegr. brightness value
14	1 byte	Actuator group B	Telegr. brightness value
15	1 byte	Actuator group C	Telegr. brightness value
16	1 byte	Actuator group D	Telegr. brightness value
17	1 byte	Actuator group E	Telegr. brightness value
18	1 byte	Actuator group F	Telegr. brightness value

General parameters

The default setting for the values is **printed in bold type**.

General:

– Object for backlighting switches	text field and status LED only text field LED
– Behaviour of backlighting at bus recovery	ON OFF
Without lightscene operation:	
– Function of auxiliary push button	no function Interrupt fault protection (approx. 5 s) Backlighting and LED on/off
With lightscene operation:	
– Function of auxiliary push button	no function Save lightscenes
– IR area of auxiliary push button	no IR blue white
– Number of lightscenes	0 / 2 / 4 / 6
Only if 2 lightscenes are selected:	
– Lightscenes are available on	Rocker 1 Rocker 2 Rocker 3
Only if 4 lightscenes are selected:	
– Lightscenes are available on	Rockers 1 and 2 Rockers 2 and 3
Only if 6 lightscenes are selected:	
– Lightscenes are available on	Rockers 1 to 3
– Wait state between telegrams by activating lightscenes (base 140 ms)	0
– Push button action interpreted as long from	280 ms / ... / 420 ms / ... / 2.1 s

Actuator:

– Status response to switching object	no / yes
– Switch ON with	minimum brightness maximum brightness Final brightness
– Status response to object of brightness value	no / yes
– Time base for dimming range	127.5 ms / 2.0 s / 33 s / 9 min / 2.3 h
– Factor for dimming range (1...255)	40

Separate for three rockers:

– Operation mode of rocker	no function Shutter sensor Dimming sensor Switching sensor
Only for switching sensor:	
– Number of switch functions	2 Functions => 2 Objects 1 Function => 1 Object
Only if 2 functions are selected:	
– Working mode of the rocker	left = TOGGLE, right = TOGGLE left = TOGGLE, right = OFF left = OFF, right = TOGGLE left = OFF, right = OFF left = TOGGLE, right = ON left = OFF, right = ON left = ON, right = TOGGLE left = ON, right = OFF left = ON, right = ON
Only if 1 function is selected:	
– Working mode of the rocker	TOGGLE left = OFF, right = ON left = ON, right = OFF

– Operation mode of LED	orientation light shows value of object rocker
Only for display of object value:	
– Colour of the LED	OFF = green, ON = red OFF = red, ON = green
For orientation light:	
– Colour of the LED	always green always red always off
Only for dimming sensor:	
– Dimming direction	left = darker, right = brighter left = brighter, right = darker
Only for shutter sensor:	
– Shutter direction	left = DOWN, right = UP left = UP, right = DOWN
– Operation mode of LED	orientation light shows value of object rocker -long
Only for orientation light:	
– Colour of the LED	always green always red always off
Only for display of object value:	
– Colour of the LED	OFF = green, ON = red OFF = red, ON = green
– Rocker is assigned to IR push button	no IR / 1 / 2 / 3 / 4 / 5
Only in connection with an IR push button:	
– IR area	white blue
For each rocker that is assigned a lightscene:	
– Rocker is assigned to two lightscenes	<----- NOTE
– Rocker is assigned to IR push button	no IR / 1 / 2 / 3 / 4 / 5
Only in connection with an IR push button:	
– IR area	white blue
Separate for actuator groups A ...F:	
– Type of actuator group ...	Switch or shutter actuator (1 bit) Dimming actuator (8 bit)
For switch or shutter actuator, separate for lightscenes 1 ... 6:	
– Preset actuator group ...	OFF / UP ON / DOWN
For dimming actuator, separate for lightscenes 1 ... 6:	
– Preset actuator group ...	0 % / 5 % / 10 % / ... / 100 %

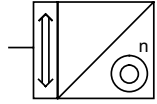
**IR LCD Switch Dim Shutter
Lightscene /12****Selection in ETS2**

- ABB
 - └ Push Button triton
 - └ Push button, 3-fold for 1SDA

The application program is intended for the 3-fold Busch-triton® switch sensor with display in connection with a switch/dim actuator FM.

The Busch-triton® switch sensor can be used for switching, dimming and shutter control as well as for controlling lightscenes. Various parameters and communication objects can be used for the rockers depending on the setting selected in the parameters “Number of lightscenes” and “Lightscenes are available on”.

If the rockers of the Busch-triton® switch sensor are not used for lightscene control, they each have the same set of parameters. With the parameter “Operation mode of rocker”, the basic switching, dimming and shutter control functions can be selected. Depending on this setting, different parameters and objects are available for the rockers. There is a common parameter “Push button action interpreted as long from” for all the rockers that are used for dimming or shutter control. Normally, the switch sensor detects a long push button action if a rocker is pressed for longer than 420 ms.

Backlighting

The backlit text fields display the functions of the rockers even in the dark. Using the communication object “Backlighting/LED”, the backlighting and status LEDs can be switched on or off if required.

The auxiliary push button can also be used for manual switching. To do so, the parameter “Function of auxiliary push button” must be set to “Backlighting and LED on/off”. When the auxiliary push button is pressed, not only is the lighting of the switch sensor switched on or off but a telegram is sent via the communication object “Backlighting/LED”. It is therefore possible to switch on the lighting for several Busch-triton® switch sensors at the same time via a common group address.

By default, the backlighting switches on after bus voltage recovery. This can also be changed via the parameter “Behaviour of backlighting at bus recovery”.

Fault protection

The auxiliary push button also makes the fault protection function available. The fault protection function causes only one basic function to be triggered when any of the rockers of the switch sensor are pressed. For example, pressing one of the three rockers via communication object no. 1 “Fault protection” switches the base lighting alternately on or off.

The fault protection function can be permanently activated or for example be timed to switch on or off via the EIB using object no. 0 “Fault protection Off/On”. If the parameter “Function of auxiliary push button” is set to “Interrupt fault protection”, the rockers can be used for different functions according to their parameter settings after pressing the auxiliary push button for approx. 5 seconds.

Dimmer output

The dimmer output has the three communication objects “Switching”, “Rel. dimming” and “Brightness value”. It can thus also be controlled by other sensors via the EIB. If a rocker of the Busch-triton® switch sensor is parameterised as a dimming sensor and the communication objects of the rocker are linked with those of the dimming actuator via a group address, the actuator can also be operated locally.

On receipt of an “On” telegram at the 1 bit communication object, the actuator can switch on with various brightness values. The values can be predefined with the parameter “Switch ON with”.

If the switch sensor is dimmed up from the OFF state or switched on with a brightness value, it sends its new status on the EIB in the basic setting. The signal is carried out at the switching and brightness value objects. This function is required for example to switch on status LEDs or to indicate the current brightness value of the dimming actuator on LCDs.

If the parameter “Status response to...” is set to “no”, this function can also be switched off.

Using the parameters “Time base ...” and “Factor for dimming range”, it is possible to set the period which the dimming actuator requires to dim up or down fully once.

IR

In addition to using the rockers, the Busch-triton® switch sensor can also be controlled remotely via an infrared hand-held transmitter. The rockers and the auxiliary push button can be assigned to the white or blue infrared area of the hand-held transmitter. The relevant setting must then be selected via the slide switch on the transmitter. The MEMO button of the transmitter corresponds to the function of the auxiliary push button of the Busch-triton® switch sensor.

LCD

The display of the Busch-triton® switch sensor can represent the values of five different communication objects.

In order to display switching states, relative variables such as brightness values, physical variables such as temperature values, the current time or date, it is possible to parameterise individually the object value of each LCD object from 1 bit to 3 bytes.

The input of the display text and several further settings is carried out using the Busch LCD management software. The software is available free of charge on the EIB CD-ROM/diskette. The function of the software is described in the Software/visualisation chapter. When entering the settings, you should ensure that the data (objects) of ETS2 and the display management software match.

Switch

In the default setting of the Busch-triton® switch sensor, there is a 1 bit communication object available for switching for each of the rockers that are not assigned lightscenes. For special applications, the parameter “Number of switch functions” can be set so that each rocker has two communication objects.

The parameter “Working mode of the rocker” determines which value the switch sensor sends when the left or the right side of the rocker is pressed.

Dim

If the operation mode of the rocker is set to “Dimming sensor”, the rocker has the communication objects “Rocker ... -short” for switching and “Rocker ... -long” for dimming.

When carrying out a switching operation, the rocker can either be pressed briefly on the left, on the right or in the middle. The switch sensor always toggles in this case.

For dimming, it is determined via the parameter “Dimming direction” which side of the rocker must be pressed and held down in order to dim up or down. When the rocker is released, the switch sensor sends the telegram “Stop dimming”.

Shutter

If the operating mode of the rocker is set to “Shutter sensor”, the switch sensor sends “Move shutter up/down” telegrams when the left or right side of the rocker is pressed for a long period. After a short operation anywhere on the rocker, it sends telegrams for stopping the shutter movement or for stepwise louvre adjustment.

The parameter “Shutter direction” determines which side of the rocker must be pressed in order to move upwards or downwards.

LED

Using the parameter “Operation mode of LED”, the LEDs can be selected for use either as an orientation light or for status display.

In the case of LEDs that are used for status display, it is possible to set which colour (red or green) is assigned to the object values “0” or “1”.

The LEDs that are used as an orientation light can either always light up red or always green or they can be switched off.

Lightscenes

In lightscene mode, up to six scenes with up to six different groups of actuators can be controlled without special lightscene modules.

The lightscenes can be specified via the device parameters. The user can then reconfigure the parameters individually according to his requirements while the installation is in operation. The auxiliary push button is used for storing new lightscenes (parameters). To do this, the parameter "Function of auxiliary push button" must be set to "Save lightscenes". To be able to use this function, the transmitting group addresses and flags must be assigned correctly when configuring the actuators.

The lightscenes are configured according to the following process.

1. The number of lightscenes and their respective rocker assignment can be set on the "General" parameter page.
2. For each of the actuator groups A ... F, it must be determined with the parameter "Type of actuator group ...", whether they use 1 bit communication objects (switch or shutter actuators) or 8 bit communication objects (dimming actuators). Depending on this setting, the ETS2 program displays various parameters and communication objects. Communication objects 13 ... 18 are used for the control of actuator groups A ... F.
3. For each of the lightscenes, values can be preset for the actuator groups on their own parameter page.
4. The rockers that are not used for lightscenes are still available for switching, dimming or shutter control. The parameter value "no function / display operation" must be selected for unassigned rockers.

If a rocker is used for recalling lightscenes, the LED indicates which side of the rocker has been pressed. It glows red when the left side is pressed and glows green when the right side is pressed. If several rockers are used, the LED of the rocker which was last pressed lights up.

Application example:

Dimmable ceiling lamps are installed in a hotel room. There is also a dimmable reading light by the bed. The light in the adjoining bathroom can also be dimmed.

From the door, it should be possible to control the dimmable ceiling lamps in the lounge/sleeping area and the bathroom light separately. Two lightscenes should be recalled via one push button action:

1. Switch all the lights to maximum brightness for cleaning the room.
2. Switch off all the lights when leaving the room.

From the bed, it should be possible to control the dimmable ceiling lamps and the reading light separately. Two lightscenes should be recalled via one push button action:

1. Dim the ceiling lamps to semi-brightness to light the way during the night and switch on the bathroom light.
2. Switch off all the lights for sleeping.

Two 3-fold Busch-triton® switch sensors, each with a dimming actuator/sensor FM and a switch/dim actuator are used. The output of the dimming actuator/sensor at the door controls the bathroom light. The output of the dimming actuator/sensor at the bed controls the reading light.

The Busch-triton® switch sensor at the door has the following parameter settings:

Number of lightscenes:
2
Lightscenes are available on:
Rocker 1
Function of auxiliary push button:
no function / display operation
Operation mode of rocker 1:
Rocker is assigned to two lightscenes
Operation mode of rocker 2:
Dimming sensor
Operation mode of rocker 3:
Dimming sensor
Rocker is assigned to IR push button:
no IR
Type of actuator group A:
Dimming actuator (8 bit)
Type of actuator group B:
Switch or shutter actuator (1 bit)
Type of actuator group C:
Switch or shutter actuator (1 bit)

The two lightscenes are defined as follows:

Lightscene 1: Base lighting
Actuator group A: 100%,
Actuator group B: ON,
Actuator group C: ON
Lightscene 2: OFF
Actuator group A: 0%,
Actuator group B: OFF,
Actuator group C: OFF

The Busch-triton® switch sensor at the bed has the following parameter settings:

Number of lightscenes:
2
Lightscenes are available on:
Rocker 1
Function of auxiliary push button:
no function / display operation
Operation mode of rocker 1:
Rocker is assigned to two lightscenes
Operation mode of rocker 2:
Dimming sensor
Operation mode of rocker 3:
Dimming sensor
Rocker is assigned to IR push button:
no IR
Type of actuator group A:
Dimming actuator (8 bit)
Type of actuator group B:
Switch or shutter actuator (1 bit)
Type of actuator group C:
Switch or shutter actuator (1 bit)

The two lightscenes are defined as follows:

Lightscene 1: Passageway lighting
Actuator group A: 50%,
Actuator group B: ON,
Actuator group C: OFF
Lightscene 2: OFF
Actuator group A: 0%,
Actuator group B: OFF,
Actuator group C: OFF

The links between the communication objects are similar for both switch sensors.

The 1 bit and 4 bit communication objects of rocker 2 are linked to the corresponding objects of the dimming actuator.

The transmit flag is set for the switching object of the dimming actuator. The status LEDs can also be controlled when retrieving lightscenes. It should be ensured that the parameter "Status response to switching object" is set to "yes".

The 1 byte communication object of actuator group A is linked to the 1 byte object of the dimming actuator. The 1 bit communication object of actuator group B is linked to the switching object of the same dimming actuator/sensor. The 1 bit communication object of actuator group C is linked to the switching object of the other dimming actuator/sensor.

In this case, the auxiliary push buttons are not used for saving lightscenes so that a hotel guest does not inadvertently modify the set lightscenes.

Communication objects
for switch sensor with two switch functions, no lightscenes

No.	Type	Object name	Function
2	3 byte	LCD object 1	Switching
3	3 byte	LCD object 2	Switching
4	3 byte	LCD object 3	Switching
5	3 byte	LCD object 4	Switching
6	3 byte	LCD object 5	Switching
7	1 bit	Dimmer	Switching
8	4 bit	Dimmer	Rel. dimming
9	1 byte	Dimmer	Brightness value
10	1 bit	Backlighting/LED	Switching
13	1 bit	Rocker 1 left	Telegr. switch
14	1 bit	Rocker 1 right	Telegr. switch
15	1 bit	Rocker 2 left	Telegr. switch
16	4 bit	Rocker 2 right	Telegr. switch
17	1 bit	Rocker 3 left	Telegr. switch
18	1 bit	Rocker 3 right	Telegr. switch

Communication objects
with fault protection
for switch sensor with one switch function, no lightscenes

No.	Type	Object name	Function
0	1 bit	Fault protection Off/On	Input telegr.
1	1 bit	Fault protection	Telegr. switch
...			
13	1 bit	Rocker 1	Telegr. switch
15	1 bit	Rocker 2	Telegr. switch
17	1 bit	Rocker 3	Telegr. switch

Communication objects
with 2 lightscenes for switch actuators

No.	Type	Object name	Function
0	3 byte	LCD object 1	Switching
1	3 byte	LCD object 2	Switching
2	3 byte	LCD object 3	Switching
3	3 byte	LCD object 4	Switching
4	3 byte	LCD object 5	Switching
5	1 bit	Dimmer	Switching
6	4 bit	Dimmer	Rel. dimming
7	1 byte	Dimmer	Brightness value
8	1 bit	Backlighting/LED	Switching
9	1 bit	Rocker 2 left	Telegr. switch
10	4 bit	Rocker 2 right	Telegr. switch
11	1 bit	Rocker 3 left	Telegr. switch
12	1 bit	Rocker 3 right	Telegr. switch
13	1 byte	Actuator group A	Telegr. switch
14	1 byte	Actuator group B	Telegr. switch
15	1 byte	Actuator group C	Telegr. switch
16	1 byte	Actuator group D	Telegr. switch
17	1 byte	Actuator group E	Telegr. switch
18	1 byte	Actuator group F	Telegr. switch

Communication objects
with 2 lightscenes for dimming actuators

No.	Type	Object name	Function
...			
13	1 byte	Actuator group A	Telegr. brightness value
14	1 byte	Actuator group B	Telegr. brightness value
15	1 byte	Actuator group C	Telegr. brightness value
16	1 byte	Actuator group D	Telegr. brightness value
17	1 byte	Actuator group E	Telegr. brightness value
18	1 byte	Actuator group F	Telegr. brightness value

Communciation objects
for dimming sensor without lightscenes

No.	Type	Object name	Function
...			
13	1 bit	Rocker 1 -short	Teleg. switch
14	4 bit	Rocker 1 -long	Teleg. dimming
15	1 bit	Rocker 2 -short	Teleg. switch
16	4 bit	Rocker 2 -long	Teleg. dimming
17	1 bit	Rocker 3 -short	Teleg. switch
18	4 bit	Rocker 3 -long	Teleg. dimming

Communciation objects
for shutter sensor without lightscenes

No.	Type	Object name	Function
...			
13	1 bit	Rocker 1 -long	Teleg. Move up/down
14	1 bit	Rocker 1 -short	Teleg. lamella adj./stop
15	1 bit	Rocker 2 -long	Teleg. Move up/down
16	1 bit	Rocker 2 -short	Teleg. lamella adj./stop
17	1 bit	Rocker 3 -long	Teleg. Move up/down
18	1 bit	Rocker 3 -short	Teleg. lamella adj./stop

Communciation objects
for 1 bit (switching) LCD object value

No.	Type	Object name	Function
...			
2	1 bit	LCD object 1	Switching
3	1 bit	LCD object 2	Switching
4	1 bit	LCD object 3	Switching
5	1 bit	LCD object 4	Switching
6	1 bit	LCD object 5	Switching

Communciation objects
for 1 byte (value) LCD object value

No.	Type	Object name	Function
...			
2	1 byte	LCD object 1	Value
3	1 byte	LCD object 2	Value
4	1 byte	LCD object 3	Value
5	1 byte	LCD object 4	Value
6	1 byte	LCD object 5	Value

Communciation objects
for 2 byte (value) LCD object value

No.	Type	Object name	Function
...			
2	2 byte	LCD object 1	Value
3	2 byte	LCD object 2	Value
4	2 byte	LCD object 3	Value
5	2 byte	LCD object 4	Value
6	2 byte	LCD object 5	Value

Communciation objects
for 3 byte (time/date) LCD object value

No.	Type	Object name	Function
...			
2	3 byte	LCD object 1	Time/date
3	3 byte	LCD object 2	Time/date
4	3 byte	LCD object 3	Time/date
5	3 byte	LCD object 4	Time/date
6	3 byte	LCD object 5	Time/date

Parameters

The default setting for the values is **printed in bold type**.

General:

– Object for backlighting switches	text field and status LED only text field LED
– Behaviour of backlighting at bus recovery	ON OFF
– Number of lightscenes	0 / 2 / 4 / 6
Without lightscene operation:	
– Function of auxiliary push button	no function / display operation Interrupt fault protection (approx. 5 s) Backlighting and LED on/off

Only for lightscene operation:

– Function of auxiliary push button	no function / display operation Save lightscenes
-------------------------------------	--

Only if 2 lightscenes are selected:

– Lightscenes are available on	Rocker 1 / Rocker 2 / Rocker 3
--------------------------------	---------------------------------------

Only if 4 lightscenes are selected:

– Lightscenes are available on	Rockers 1 and 2 / Rockers 2 and 3
--------------------------------	--

Only if 6 lightscenes are selected:

– Lightscenes are available on	Rockers 1 to 3
--------------------------------	-----------------------

– Wait state between telegrams by activating lightscenes (base 140 ms)	0
--	----------

– IR area of auxiliary push button (MEMO)	no IR white blue
– Push button action interpreted as long from	280 ms / 420 ms / ... / 2.1 s

Actuator:

– Status response to switching object	no / yes
– Status response to object of brightness value	no / yes
– Switch ON with	minimum brightness maximum brightness Final brightness
– Time base for dimming range	127.5 ms / 2.0 s / 33 s / 9 min / 2.3 h
– Factor for dimming range (1...255)	40

Separate for each rocker:

When lightscenes are assigned:

– Rocker is assigned to two lightscenes	← NOTE
– Rocker is assigned to IR push button	no IR / 1 / 2 / 3 / 4 / 5
Only in connection with IR push button:	
– IR area	white blue

When lightscenes are not assigned:

– Operation mode of rocker	no function / display operation Shutter sensor Dimming sensor Switching sensor
----------------------------	--

For switch sensor operating mode:	
– Number of switch functions	2 Functions => 2 Objects 1 Function => 1 Object
If 1 function is selected:	
– Working mode of the rocker	TOGGLE left = OFF, right = ON left = ON, right = OFF
If 2 functions are selected:	
– Working mode of the rocker	left = TOGGLE, right = TOGGLE left = TOGGLE, right = OFF left = OFF, right = TOGGLE left = OFF, right = OFF left = TOGGLE, right = ON left = OFF, right = ON left = ON, right = TOGGLE left = ON, right = OFF left = ON, right = ON
For dimming sensor operating mode:	
– Dimming direction	left = darker, right = brighter left = brighter, right = darker
For shutter sensor operating mode:	
– Shutter direction	left = DOWN, right = UP left = UP, right = DOWN
– Operation mode of LED	orientation light shows value of object rocker ...
Only for display of object value:	
– Colour of the LED	OFF = green, ON = red OFF = red, ON = green
Only for orientation light:	
– Colour of the LED	always green always red always off
– Rocker is assigned to IR push button	no IR / 1 / 2 / 3 / 4 / 5
Only in connection with IR push button:	
– IR area	white blue
Actuator types:	
Separate for each actuator group:	
– Type of actuator group A ... F	Switch or shutter actuator (1 bit) Dimming actuator (8 bit)
Separate for each lightscene:	
For switch or shutter actuator:	
–Preset actuator group A ... F	OFF / UP ON / DOWN
For dimming actuator:	
– Preset actuator group A ... F	0 % / 5 % / ... / 95 % / 100 %
Display:	
Separate for each LCD object:	
– Type of LCD object No. ...	1 Bit: Switching 1 Byte (Value) 2 Byte (Value) 3 Byte (Time/Date)

IR Switch Dim Shutter /1

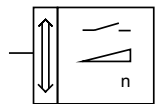

Selection in ETS2

- ABB
 - └ Push Button triton
 - └ Push button, 5-fold for 1SDA

The application program is intended for the 5-fold Busch-triton® switch sensor application module in connection with a switch/dim actuator FM.

The Busch-triton® switch sensor can be used for switching, dimming and shutter control.

The rockers of the Busch-triton® switch sensor each have the same set of parameters. With the parameter "Operation mode of rocker", the basic switching, dimming and shutter control functions can be selected. Depending on this setting, different parameters and objects are available for the rockers. There is a common parameter "Push button action interpreted as long from" for all the rockers that are used for dimming or shutter control. Normally, the switch sensor detects a long push button action if a rocker is pressed for longer than 420 ms.

Backlighting

The backlit text fields display the functions of the rockers even in the dark. Using the communication object "Backlighting/LED", the backlighting and status LEDs can be switched on or off if required.

The auxiliary push button can also be used for manual switching. To do so, the parameter "Function of auxiliary push button" must be set to "Backlighting and LED on/off". When the auxiliary push button is pressed, not only is the lighting of the switch sensor switched on or off but a telegram is sent via the communication object "Backlighting/LED". It is therefore possible to switch on the lighting for several Busch-triton® switch sensors at the same time via a common group address.

By default, the backlighting switches on after bus voltage recovery. This can also be changed via the parameter "Behaviour of backlighting at bus recovery".

Fault protection

The auxiliary push button also makes the fault protection function available. The fault protection function causes only one basic function to be triggered when any of the rockers of the switch sensor are pressed. For example, pressing one of the five rockers via communication object no. 1 "Fault protection" switches the base lighting alternately on or off.

The fault protection function can be permanently activated or for example be timed to switch on or off via the EIB using object no. 0 "Fault protection Off/On". If the parameter "Function of auxiliary push button" is set to "Interrupt fault protection", the rockers can be used for different functions according to their parameter settings after pressing the auxiliary push button for approx. 5 seconds.

Dimmer output

The dimmer output has the three communication objects "Telegr. switch / switch", "Tel. dimming / rel. dimming" and "Brightness value". It can thus also be controlled by other sensors via the EIB. If a rocker of the Busch-triton® switch sensor is parameterised as a dimming sensor and the communication objects of the rocker are linked with those of the dimming actuator via a group address, the actuator can also be operated locally.

If the switch sensor is dimmed up from the OFF state or switched on with a brightness value, it sends its new status on the EIB in the basic setting. The signal is carried out at the switching and brightness value objects. This function is required for example to switch on status LEDs.

On receipt of an "On" telegram at the 1 bit communication object, the actuator can switch on with minimum or maximum brightness. The values can be predefined with the parameter "Switch ON with".

IR

In addition to using the rockers, the Busch-triton® switch sensor can also be controlled remotely via an infrared hand-held transmitter. The five rockers and the auxiliary push button can be assigned to the white or blue infrared area of the hand-held transmitter. The relevant setting must then be selected via the slide switch on the transmitter. The MEMO button of the transmitter corresponds to the function of the auxiliary push button of the Busch-triton® switch sensor.

Switch

In the default setting of the Busch-triton® switch sensor, there is a 1 bit communication object available for switching for each of the rockers. For special applications, the parameter "Number of switch functions" can be set so that each rocker has two communication objects.

The parameter "Working mode of the rocker" determines which value the switch sensor sends when the left or the right side of a rocker is pressed.

Dim

If the operation mode of the rocker is set to "Dimming sensor", the rocker has the communication objects "Rocker ... -short" for switching and "Rocker ... -long" for dimming.

When carrying out a switching operation, the rocker can either be pressed briefly on the left, on the right or in the middle. The switch sensor always toggles in this case.

For dimming, it is determined via the parameter "Dimming direction" which side of the rocker must be pressed and held down in order to dim up or down. When the rocker is released, the switch sensor sends the telegram "Stop dimming".

Shutter

If the operating mode of the rocker is set to "Shutter sensor", the switch sensor sends "Move shutter up/down" telegrams when the left or right side of the rocker is pressed for a long period. After a short operation anywhere on the rocker, it sends telegrams for stopping the shutter movement or for stepwise louvre adjustment.

The parameter "Shutter direction" determines which side of the rocker must be pressed in order to move upwards or downwards.

LED

If the backlighting of the text fields is switched on, the LEDs can be selected for use either as an orientation light or to display the value of a communication object using the parameter "Operation mode of LED".

In the case of LEDs that are used for status display, it is possible to set which colour (red or green) is assigned to the object values "0" or "1".

The LEDs that are used as an orientation light can either always light up red or always green or they can be switched off.

Application example:

In a training room, there is a group of dimmable downlighters above the seminar participants, two dimmable spotlights above the lecture area and two groups with switchable wall lights. The room can be made darker using two electrically driven shutters.

When the seminar participants enter the room, they should normally only be able to switch the wall lights as the base lighting.

Two 5-fold Busch-triton® switch sensors with dimming actuator/sensors are used together with a dimming actuator, a switch actuator and two shutter actuators.

The two Busch-triton® switch sensors at the doors have almost the same parameter settings:

Function of auxiliary push button:

Interrupt fault protection

Operation mode of rocker 1:

Switching sensor,
1 function, TOGGLE

Operation mode of LED:

shows value of object rocker

Colour of the LED:

OFF = green, ON = red

Operation mode of rocker 2:

Dimming sensor

Operation mode of LED:

shows value of object rocker -short

Colour of the LED:

OFF = green, ON = red

Operation mode of rocker 3:

Dimming sensor

Operation mode of LED:

shows value of object rocker -short

Colour of the LED:

OFF = green, ON = red

Operation mode of rocker 4:

Shutter sensor

Operation mode of LED:

orientation light

Colour of the LED:

always off

Operation mode of rocker 5:

Shutter sensor

Operation mode of LED:

orientation light

Colour of the LED:

always off

The parameters "IR area" have different settings so that both switch sensors do not send telegrams when remote control is used.

The outputs of the dimming actuators/sensors each control one of the spotlights above the lecture area.

The link between the group addresses and the communication objects is almost identical.

The 1 bit communication objects no. 2 "Fault protection" are linked with the 1 bit communication objects "Rocker 1" for both switch sensors and with the output of the switch actuator for the wall lights.

The 1 bit and 4 bit communication objects of rocker 2 are linked with the corresponding objects of the dimming actuators for the downlighters.

The communication objects of rocker 3 are linked with the corresponding objects of the dimming actuator/sensors. If two dimming actuators are using identical group addresses, only one of them should send telegrams with the current switching state. Otherwise, the actuators may send telegrams continuously. For this reason, the transmit flag should be deleted at the 1 bit object no. 13 for one of the two devices.

The communication objects of rockers 4 and 5 for raising and lowering the shutters and for louvre adjustment are linked to the corresponding objects of the shutter actuators.

In principle, the switch sensors operate with an active fault protection function. The wall lights are switched after each operation of any of the rockers.

The lecturer can carry out the same functions via remote control. The IR area can be set as required as both switch sensors react to different settings but carry out the same functions.

Communication objects
for switch sensor with two switch functions

No.	Type	Object name	Function
1	1 bit	Backlighting/LED	Switching
3	1 bit	Rocker 1 left	Teleg. switch
4	1 bit	Rocker 1 right	Teleg. switch
5	1 bit	Rocker 2 left	Teleg. switch
6	1 bit	Rocker 2 right	Teleg. switch
7	1 bit	Rocker 3 left	Teleg. switch
8	1 bit	Rocker 3 right	Teleg. switch
9	1 bit	Rocker 4 left	Teleg. switch
10	1 bit	Rocker 4 right	Teleg. switch
11	1 bit	Rocker 5 left	Teleg. switch
12	1 bit	Rocker 5 right	Teleg. switch
13	1 bit	Output	Teleg. switch / switch
14	4 bit	Dimmer	Teleg. dimming / rel. dimming
15	1 byte	Dimmer	Brightness value

Communication objects
for fault protection

No.	Type	Object name	Function
0	1 bit	Input telegr.	Fault protection Off/On
1	1 bit	Backlighting/LED	Switching
2	1 bit	Fault protection	Teleg. switch
...			

Communication objects
for switch sensor with one switch function

No.	Type	Object name	Function
...			
3	1 bit	Rocker 1	Teleg. switch
5	1 bit	Rocker 2	Teleg. switch
7	1 bit	Rocker 3	Teleg. switch
9	1 bit	Rocker 4	Teleg. switch
11	1 bit	Rocker 5	Teleg. switch
...			

Communication objects
for dimming sensor

No.	Type	Object name	Function
...			
3	1 bit	Rocker 1 -short	Teleg. switch
4	1 bit	Rocker 1 -long	Teleg. dimming
5	1 bit	Rocker 2 -short	Teleg. switch
6	1 bit	Rocker 2 -long	Teleg. dimming
7	1 bit	Rocker 3 -short	Teleg. switch
8	1 bit	Rocker 3 -long	Teleg. dimming
9	1 bit	Rocker 4 -short	Teleg. switch
10	1 bit	Rocker 4 -long	Teleg. dimming
11	1 bit	Rocker 5 -short	Teleg. switch
12	1 bit	Rocker 5 -long	Teleg. dimming
...			

Communication objects
for shutter sensor

No.	Type	Object name	Function
...			
3	1 bit	Rocker 1 -long	Teleg. Move up/down
4	1 bit	Rocker 1 -short	Teleg. lamella adj./stop
5	1 bit	Rocker 2 -long	Teleg. Move up/down
6	1 bit	Rocker 2 -short	Teleg. lamella adj./stop
7	1 bit	Rocker 3 -long	Teleg. Move up/down
8	1 bit	Rocker 3 -short	Teleg. lamella adj./stop
9	1 bit	Rocker 4 -long	Teleg. Move up/down
10	1 bit	Rocker 4 -short	Teleg. lamella adj./stop
11	1 bit	Rocker 5 -long	Teleg. Move up/down
12	1 bit	Rocker 5 -short	Teleg. lamella adj./stop
...			

Parameters

The default setting for the values is **printed in bold type**.

General:	
– Object for backlighting switches	text field and status LED only text field LED
– Behaviour of backlighting at bus voltage recovery	ON OFF
– Function of auxiliary push button	no function interrupt fault protection (approx. 5 s) Backlighting and LED on/off
– IR area	blue white no IR
– Push button action interpreted as long from	280 ms / 420 ms / 560 ms / 700 ms / 800 ms
– Switch ON with	minimum brightness maximum brightness
Separate for each rocker:	
– Operation mode of rocker	no function Shutter sensor Dimming sensor Switching sensor
For switch sensor:	
– Number of switch functions	2 Functions => 2 Objects 1 Function => 1 Object
If 1 function is selected:	
– Working mode of the rocker	TOGGLE left = OFF, right = ON left = ON, right = OFF
– Operation mode of LED	orientation light shows value of object rocker
For display of object value:	
– Colour of the LED	OFF = green, ON = red OFF = red, ON = green
For orientation light:	
– Colour of the LED	always green always red always off
If 2 functions are selected:	
– Working mode of the rocker	left = TOGGLE, right = TOGGLE left = TOGGLE, right = OFF left = OFF, right = TOGGLE left = OFF, right = OFF left = TOGGLE, right = ON left = OFF, right = ON left = ON, right = TOGGLE left = ON, right = OFF left = ON, right = ON
– Operation mode of LED	orientation light shows value of object rocker left
For display of object value:	
– Colour of the LED	OFF = green, ON = red OFF = red, ON = green
For orientation light:	
– Colour of the LED	always green always red always off
For dimming sensor:	
– Dimming direction	left = darker, right = brighter left = brighter, right = darker
– Operation mode of LED	orientation light shows value of object rocker -short
For display of object value:	
– Colour of the LED	OFF = green, ON = red OFF = red, ON = green

For orientation light:	
– Colour of the LED	always green always red always off
For shutter sensor:	
– Shutter direction	left = DOWN, right = UP left = UP, right = DOWN
– Operation mode of LED	orientation light shows value of object rocker -long
For display of object value:	
– Colour of the LED	OFF = green, ON = red OFF = red, ON = green
For orientation light:	
– Colour of the LED	always green always red always off
If no function is selected:	
– No setting options available	

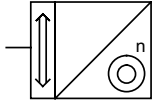
IR Switch Dim Shutter Lightscene /4**Selection in ETS2**

- ABB
 - Push Button triton
 - Push button, 5-fold for 1SDA

The application program is intended for the 5-fold Busch-triton® switch sensor application module in connection with a switch/dim actuator FM.

The Busch-triton® switch sensor can be used for switching, dimming and shutter control as well as for controlling lightscenes. Various parameters and communication objects are available for the five rockers depending on the setting in the parameter “Number of lightscenes”.

Four lightscenes are available in the default setting which can be recalled via rockers 4 and 5.

The rockers of the Busch-triton® switch sensor that are not used for lightscene control each have the same set of parameters. With the parameter “Operation mode of rocker”, the basic switching, dimming and shutter control functions can be selected. Depending on this setting, different parameters and objects are available for the rockers. There is a common parameter “Push button action interpreted as long from” for all the rockers that are used for dimming or shutter control. Normally, the switch sensor detects a long push button action if a rocker is pressed for longer than 420 ms.

Backlighting

The backlit text fields display the functions of the rockers even in the dark. Using the communication object “Backlighting/LED”, the backlighting and status LEDs can be switched on or off if required.

The auxiliary push button can also be used for manual switching. To do so, the parameter “Function of auxiliary push button” must be set to “Backlighting and LED on/off”. When the auxiliary push button is pressed, not only is the lighting of the switch sensor switched on or off but a telegram is sent via the communication object “Backlighting/LED”. It is therefore possible to switch on the lighting for several Busch-triton® switch sensors at the same time via a common group address.

By default, the backlighting switches on after bus voltage recovery. This can also be changed via the parameter “Behaviour of backlighting at bus recovery”.

Dimmer output

The dimmer output has the three communication objects “Switching”, “Rel. dimming” and “Brightness value”. It can thus also be controlled by other sensors via the EIB. If a rocker of the Busch-triton® switch sensor is parameterised as a dimming sensor and the communication objects of the rocker are linked with those of the dimming actuator via a group address, the actuator can also be operated locally.

If the switch sensor is dimmed up from the OFF state or switched on with a brightness value, it sends its new status on the EIB in the basic setting. This function is required for example to switch on status LEDs.

If the parameter “Status response to...” is set to “no”, this function can also be switched off.

On receipt of an “On” telegram at the 1 bit communication object, the actuator can switch on with minimum or maximum brightness. The value can be predefined with the parameter “Switch on with”.

Using the parameters “Time base ...” and “Factor for dimming range”, it is possible to set the period which the dimming actuator requires to dim up or down fully once.

IR

In addition to using the rockers, the Busch-triton® switch sensor can also be controlled remotely via an infrared hand-held transmitter. The five rockers and the auxiliary push button can be assigned to the white or blue infrared area of the hand-held transmitter. The relevant setting must then be selected via the slide switch on the transmitter. The MEMO button of the transmitter corresponds to the function of the auxiliary push button of the Busch-triton® switch sensor.

Switch

In the default setting of the Busch-triton® switch sensor, there is a 1 bit communication object available for switching for each of the rockers that are not assigned lightscenes. For special applications, the parameter "Number of switch functions" can be set so that each rocker has two communication objects.

The parameter "Working mode of the rocker" determines which value the switch sensor sends when the left or the right side of the rocker is pressed.

Dim

If the operation mode of the rocker is set to "Dimming sensor", the rocker has the communication objects "Rocker ... -short" for switching and "Rocker ... -long" for dimming.

When carrying out a switching operation, the rocker can either be pressed briefly on the left, on the right or in the middle. The switch sensor always toggles in this case.

For dimming, it is determined via the parameter "Dimming direction" which side of the rocker must be pressed and held down in order to dim up or down. When the rocker is released, the switch sensor sends the telegram "Stop dimming".

Shutter

If the operating mode of the rocker is set to "Shutter sensor", the switch sensor sends "Move shutter up/down" telegrams when the left or right side of the rocker is pressed for a long period. After a short operation anywhere on the rocker, it sends telegrams for stopping the shutter movement or for stepwise louvre adjustment.

The parameter "Shutter direction" determines which side of the rocker must be pressed in order to move upwards or downwards.

LED

If the backlighting of the text fields is switched on, the LEDs can be selected for use either as an orientation light or for status display using the parameter "Operation mode of LED".

In the case of LEDs that are used for status display, it is possible to set which colour (red or green) is assigned to the object values "0" or "1".

The LEDs that are used as an orientation light can either always light up red or always green or they can be switched off.

Lightscenes

In lightscene mode, up to six scenes with up to six different groups of actuators can be controlled without special lightscene modules.

The lightscenes can be specified via the device parameters. The user can then reconfigure the parameters individually according to his requirements while the installation is in operation. The auxiliary push button is used for storing new lightscenes (parameters). To do this, the parameter "Function of auxiliary push button" must be set to "Save lightscenes". To be able to use this function, the transmitting group addresses and flags must be assigned correctly when configuring the actuators.

The lightscenes are configured according to the following process.

1. The number of lightscenes and their respective rocker assignment can be set on the "General" parameter page.
2. For each of the actuator groups A ... F, it must be determined with the parameter "Type of actuator group ...", whether they use 1 bit communication objects (switch or shutter actuators) or 8 bit communication objects (dimming actuators). Depending on this setting, the ETS2 program displays various parameters and communication objects. Communication objects 13 ... 18 are used for the control of actuator groups A ... F.
3. For each of the lightscenes, values can be preset for the actuator groups on their own parameter page.
4. The rockers that are not used for lightscenes are still available for switching, dimming or shutter control. The parameter value "no function" must be selected for unassigned rockers.

If a rocker is used for recalling lightscenes, the LED indicates which side of the rocker has been pressed. It glows red when the left side is pressed and glows green when the right side is pressed. If several rockers are used, the LED of the rocker which was last pressed lights up.

Application example:

A dimmable lamp is installed in a hotel room in the sleeping area together with a dimmable lamp in the entrance. There is also a reading light by the bed. The room can be darkened with an electrically driven blind. The light in the adjoining bathroom can also be dimmed.

From the door, it should be possible to operate the dimmable lamps in the sleeping area and entrance together but operate the light in the bathroom separately. It should also be possible to operate the blind.

Four lightscenes can be recalled via a push button action:

1. Switch all the lights to almost maximum brightness and raise the blind to clean the room.
2. Switch off all the lights and raise the blind when leaving the room.
3. Dim the lights in the bathroom and entrance to semi-brightness to light the way.
4. Dim all the lights except for the bathroom light to 80% brightness and lower the blind in the evening.

From the bed, it should be possible to switch the lights in the sleeping area and entrance together but dim the reading light separately. It should also be possible to operate the blind.

Four lightscenes should be recalled via a push button action:

1. Dim the lights in the bathroom and entrance to semi-brightness to light the way during the night and switch off the reading light.
2. Switch off all the lights for sleeping.
3. Switch on all the lights with maximum brightness for waking up.
4. Dim the lights to a brightness value of 60%.

Two 5-fold Busch-triton® switch sensors are used, each with a dimming actuator/sensor FM together with two switch/dim actuators and a shutter actuator. The dimming actuator/sensor FM at the door controls the lights in the entrance while the dimming actuator/sensor FM by the bed controls the reading light.

The Busch-triton® switch sensor at the door has the following parameter settings:

Number of lightscenes:

4

Function of auxiliary push button:

no function

Operation mode of rocker 1:

Dimming sensor

Operation mode of rocker 2:

Dimming sensor

Operation mode of rocker 3:

Shutter sensor

Operation mode of rocker 4:

Rocker is assigned to two lightscenes

Operation mode of rocker 5:

Rocker is assigned to two lightscenes

Rocker is assigned to IR push button:

no IR

Type of actuator group A:

Dimming actuator (8 bit)

Type of actuator group B:

Dimming actuator (8 bit)

Type of actuator group C:

Dimming actuator (8 bit)

Type of actuator group D:

Dimming actuator (8 bit)

Type of actuator group E:

Switch or shutter actuator (1 bit)

The lightscenes are defined as follows:

Lightscene 1: Base lighting

Actuator group A: 90%,

Actuator group B: 90%,

Actuator group C: 90%,

Actuator group D: 90%,

Actuator group E: UP

Lightscene 2: OFF

Actuator group A: 0%,

Actuator group B: 0%,

Actuator group C: 0%,

Actuator group D: 0%,

Actuator group E: UP

Lightscene 3: Passageway lighting

Actuator group A: 50%,

Actuator group B: 50%,

Actuator group C: 0%,

Actuator group D: 0%,

Actuator group E: UP

Lightscene 4: Evening

Actuator group A: 80%,

Actuator group B: 0%,

Actuator group C: 80%,

Actuator group D: 80%,

Actuator group E: UP

The 1 bit and 4 bit communication objects of rocker 1 are linked with the objects of the dimming actuator/sensor and the dimming actuator for the sleeping area.

The two objects of rocker 2 are linked with the corresponding objects of the actuators that control the lights in the bathroom.

The transmit flags are set for the switching objects of the dimming actuators. The status LEDs can also be controlled when the lightscenes are recalled. It should be ensured that the parameter "Status response to object of brightness value" is set to "yes".

The two objects of rocker 3 are linked with the corresponding objects of the shutter actuator.

The 1 byte object of actuator group A is linked with the 1 byte object of the dimming actuator/sensor at the door.

The 1 byte communication objects of actuator groups B and C are linked with the 1 byte objects of the dimming actuators. Actuator group B is for the dimming actuator in the bathroom while actuator group C is for the dimming actuator in the sleeping area.

The 1 byte communication object of actuator group D is linked with the 1 byte object of the dimming actuator/sensor by the bed.

The 1 bit communication object of actuator group E is linked with the object of the shutter actuator that raises and lowers the blind.

The Busch-triton® switch sensor by the bed has the following parameter settings:

Number of lightscenes:

4

Function of auxiliary push button:

no function

Operation mode of rocker 1:

Dimming sensor

Operation mode of rocker 2:

Dimming sensor

Operation mode of rocker 3:

Shutter sensor

Operation mode of rocker 4:

Rocker is assigned to two lightscenes

Operation mode of rocker 5:

Rocker is assigned to two lightscenes

Rocker is assigned to IR push button:

no IR

Type of actuator group A:

Dimming actuator (8 bit)

Type of actuator group B:

Dimming actuator (8 bit)

Type of actuator group C:

Dimming actuator (8 bit)

Type of actuator group D:

Dimming actuator (8 bit)

The lightscenes are defined as follows:

Lightscene 1: Passageway lighting

Actuator group A: 40%,

Actuator group B: 40%,

Actuator group C: 40%,

Actuator group D: 0%

Lightscene 2: OFF

Actuator group A: 0%,

Actuator group B: 0%,

Actuator group C: 0%,

Actuator group D: 0%

Lightscene 3: Waking up

Actuator group A: 100%,

Actuator group B: 100%,

Actuator group C: 100%,

Actuator group D: 100%

Lightscene 4: Morning

Actuator group A: 60%,

Actuator group B: 60%,

Actuator group C: 60%,

Actuator group D: 60%

The 1 bit and 4 bit communication objects of rocker 1 are linked with the corresponding objects of the actuators for the lights in the entrance and in the sleeping area.

The two objects of rocker 2 are linked with the objects of the dimming actuator/sensor.

The transmit flags are set for the switching objects of the dimming actuators. The status LEDs can also be controlled when the lightscenes are recalled. It should be ensured that the parameter "Status response to object of brightness value" is set to "yes".

The two objects of rocker 3 are linked with the corresponding objects of the shutter actuator.

The 1 byte objects of actuator groups A and B are linked with the 1 byte objects of the dimming actuators.

The 1 byte communication object of actuator group C is linked with the 1 byte object of the dimming actuator/sensor at the door.

The 1 byte communication object of actuator group D is linked with the 1 byte object of the dimming actuator/sensor by the bed.

In this case, the auxiliary push buttons are not used for saving lightscenes so that a hotel guest does not inadvertently modify the set lightscenes. The read flag should not however be set for the communication objects that are used for shutter control in both the sensors and the actuator. If it is required that the lightscenes should be parameterised locally, this prevents the blind from being inadvertently set in motion.

Communication objects

for switch sensor with 2 switch functions and 4 lightscenes on rockers 4 and 5

No.	Type	Object name	Function
3	1 bit	Dimmer	Switching
4	4 bit	Dimmer	Rel. dimming
5	1 byte	Dimmer	Brightness value
6	1 bit	Backlighting/LED	Switching
7	1 bit	Rocker 1 left	Telegr. switch
8	1 bit	Rocker 1 right	Telegr. switch
9	1 bit	Rocker 2 left	Telegr. switch
10	1 bit	Rocker 2 right	Telegr. switch
11	1 bit	Rocker 3 left	Telegr. switch
12	1 bit	Rocker 3 right	Telegr. switch
13	1 bit	Actuator group A	Telegr. switch
14	1 bit	Actuator group B	Telegr. switch
15	1 bit	Actuator group C	Telegr. switch
16	1 bit	Actuator group D	Telegr. switch
17	1 bit	Actuator group E	Telegr. switch
18	1 bit	Actuator group F	Telegr. switch

Communication objects

for switch sensor with 2 switch functions, no lightscenes

No.	Type	Object name	Function
...			
8	1 bit	Backlighting/LED	Switching
9	1 bit	Rocker 1 left	Telegr. switch
10	1 bit	Rocker 1 right	Telegr. switch
11	1 bit	Rocker 2 left	Telegr. switch
12	1 bit	Rocker 2 right	Telegr. switch
13	1 bit	Rocker 3 left	Telegr. switch
14	1 bit	Rocker 3 right	Telegr. switch
15	1 bit	Rocker 4 left	Telegr. switch
16	1 bit	Rocker 4 right	Telegr. switch
17	1 bit	Rocker 5 left	Telegr. switch
18	1 bit	Rocker 5 right	Telegr. switch

Communication objects

for switch sensor with 2 switch functions and 6 lightscenes with switch actuators on rockers 1 to 3

No.	Type	Object name	Function
...			
8	1 bit	Backlighting/LED	Switching
9	1 bit	Rocker 4 left	Telegr. switch
10	1 bit	Rocker 4 right	Telegr. switch
11	1 bit	Rocker 5 left	Telegr. switch
12	1 bit	Rocker 5 right	Telegr. switch
13	1 bit	Actuator group A	Telegr. switch
14	1 bit	Actuator group B	Telegr. switch
15	1 bit	Actuator group C	Telegr. switch
16	1 bit	Actuator group D	Telegr. switch
17	1 bit	Actuator group E	Telegr. switch
18	1 bit	Actuator group F	Telegr. switch

Communication objects

for lightscenes with dimming actuators

No.	Type	Object name	Function
...			
13	1 byte	Actuator group A	Telegr. brightness value
14	1 byte	Actuator group B	Telegr. brightness value
15	1 byte	Actuator group C	Telegr. brightness value
16	1 byte	Actuator group D	Telegr. brightness value
17	1 byte	Actuator group E	Telegr. brightness value
18	1 byte	Actuator group F	Telegr. brightness value

Communication objects
for switch sensor with 1 switch
function, no lightscenes

No.	Type	Object name	Function
...			
8	1 bit	Backlighting/LED	Switching
9	1 bit	Rocker 1	Teleg. switch
11	1 bit	Rocker 2	Teleg. switch
13	1 bit	Rocker 3	Teleg. switch
15	1 bit	Rocker 4	Teleg. switch
17	1 bit	Rocker 5	Teleg. switch

Communication objects
for dimming sensor

No.	Type	Object name	Function
...			
8	1 bit	Backlighting/LED	Switching
9	1 bit	Rocker 1 -short	Teleg. switch
10	1 bit	Rocker 1 -long	Teleg. dimming
11	1 bit	Rocker 2 -short	Teleg. switch
12	1 bit	Rocker 2 -long	Teleg. dimming
13	1 bit	Rocker 3 -short	Teleg. switch
14	1 bit	Rocker 3 -long	Teleg. dimming
15	1 bit	Rocker 4 -short	Teleg. switch
16	1 bit	Rocker 4 -long	Teleg. dimming
17	1 bit	Rocker 5 -short	Teleg. switch
18	1 bit	Rocker 5 -long	Teleg. dimming

Communication objects
for shutter sensor

No.	Type	Object name	Function
...			
8	1 bit	Backlighting/LED	Switching
9	1 bit	Rocker 1 -long	Teleg. Move up/down
10	1 bit	Rocker 1 -short	Teleg. lamella adj./stop
11	1 bit	Rocker 2 -long	Teleg. Move up/down
12	1 bit	Rocker 2 -short	Teleg. lamella adj./stop
13	1 bit	Rocker 3 -long	Teleg. Move up/down
14	1 bit	Rocker 3 -short	Teleg. lamella adj./stop
15	1 bit	Rocker 4 -long	Teleg. Move up/down
16	1 bit	Rocker 4 -short	Teleg. lamella adj./stop
17	1 bit	Rocker 5 -long	Teleg. Move up/down
18	1 bit	Rocker 5 -short	Teleg. lamella adj./stop

Parameters

The default setting for the values is **printed in bold type**.

General:	
– Object for backlighting switches	text field and status LED only text field LED
– Behaviour of backlighting at bus recovery	ON OFF
– Number of lightscenes	0 / 4 / 6
Only for lightscene operation:	
– Function of auxiliary push button	no function Save lightscenes
– Wait state between telegrams by activating lightscenes (base 140 ms)	0
Without lightscene operation:	
– Function of auxiliary push button	no function Backlighting and LED on/off
– IR area	blue white no IR
– Push button action interpreted as long from	280 ms / 420 ms / ... / 2.1 s
Actuator:	
– Status response to switching object	no / yes
– Status response to object of brightness value	no / yes
– Switch on with	minimum brightness maximum brightness
– Time base for dimming range	127.5 ms / 2 s / 33 s / 9 min / 2.3 h
– Factor for dimming range (1...255)	2
Separate for each rocker:	
When lightscenes are assigned:	
– Rocker is assigned to two lightscenes	← NOTE
Without assignment of lightscenes:	
– Operation mode of rocker	no function Shutter sensor Dimming sensor Switching sensor

For switch sensor:	
– Number of switch functions	2 Functions => 2 Objects 1 Function => 1 Object
If 1 function is selected:	
– Working mode of the rocker	TOGGLE left = OFF, right = ON left = ON, right = OFF
If 2 functions are selected:	
– Working mode of the rocker	left = TOGGLE, right = TOGGLE left = TOGGLE, right = OFF left = OFF, right = TOGGLE left = OFF, right = OFF left = TOGGLE, right = OFF left = OFF, right = ON left = ON, right = TOGGLE left = ON, right = OFF left = ON, right = ON
For dimming sensor:	
– Dimming direction	left = darker, right = brighter left = brighter, right = darker
For shutter sensor:	
– Shutter direction	left = DOWN, right = UP left = UP, right = DOWN
– Operation mode of LED	orientation light shows value of object rocker ...
For display of object value:	
– Colour of the LED	OFF = green, ON = red OFF = red, ON = green
For orientation light:	
– Colour of the LED	always green always red always off
Without a rocker function:	
– No setting options available	
Actuator types:	
Separate for each actuator group:	
– Type of actuator group A ... F	Switch or shutter actuator (1 bit) Dimming actuator (8 bit)
Separate for each lightscene:	
For switch or shutter actuator:	
– Preset actuator group A ... F	OFF / UP ON / DOWN
For dimming actuator:	
– Preset actuator group A ... F	0 % / 5 % / ... / 95 % / 100 %

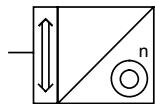
IR LCD Switch Dim Shutter /3**Selection in ETS2**

- ABB
 - Push Button triton
 - Push button, 5-fold for 1SDA

The application program is intended for the 5-fold Busch-triton® switch sensor application module with display in connection with a switch/dim actuator FM.

The Busch-triton® switch sensor can be used for switching, dimming and shutter control.

Rockers 1, 2, 4 and 5 of the Busch-triton® switch sensor each have the same set of parameters. With the parameter "Operation mode of rocker", the basic switching, dimming and shutter control functions can be selected. Depending on this setting, different parameters and objects are available for the rockers. There is a common parameter "Push button action interpreted as long from" for all the rockers that are used for dimming or shutter control. Normally, the switch sensor detects a long push button action if a rocker is pressed for longer than 420 ms.

Backlighting

The backlit text fields display the functions of the rockers even in the dark. Using the communication object "Backlighting/LED", the backlighting and status LEDs can be switched on or off if required.

The auxiliary push button can also be used for manual switching. To do so, the parameter "Function of auxiliary push button" must be set to "Backlighting and LED on/off". When the auxiliary push button is pressed, not only is the lighting of the switch sensor switched on or off but a telegram is sent via the communication object "Backlighting/LED". It is therefore possible to switch on the lighting for several Busch-triton® switch sensors at the same time via a common group address.

By default, the backlighting switches on after bus voltage recovery. This can also be changed via the parameter "Behaviour of backlighting at bus recovery".

Fault protection

The auxiliary push button also makes the fault protection function available. The fault protection function causes only one basic function to be triggered when any of the rockers of the switch sensor are pressed. For example, pressing one of the five rockers via communication object no. 1 "Fault protection" switches the base lighting alternately on or off.

The fault protection function can be permanently activated or for example be timed to switch on or off via the EIB using object no. 0 "Fault protection Off/On". If the parameter "Function of auxiliary push button" is set to "Interrupt fault protection", the rockers can be used for different functions according to their parameter settings after pressing the auxiliary push button for approx. 5 seconds.

Dimmer output

The output of the dimming actuator/sensor is linked internally to rocker 3 via objects no. 7 and 8. It can therefore be operated via rocker 3 without any further local connection. If the output should also be controlled via the bus, communication objects no. 7 "Output, Telegr. switch / switch" and no. 8 "Dimmer, Telegr. dimming / rel. dimming" can be linked with the objects of the other switch sensor. Object no. 9 "Dimmer, Brightness value" enables the integration of the output into lightscene control.

IR

In addition to using the rockers, the Busch-triton® switch sensor can also be controlled remotely via an infrared hand-held transmitter. The five rockers and the auxiliary push button can be assigned to the white or blue infrared area of the hand-held transmitter. The relevant setting must then be selected via the slide switch on the transmitter. The MEMO button of the transmitter corresponds to the function of the auxiliary push button of the Busch-triton® switch sensor.

LCD

The display of the Busch-triton® switch sensor can represent the values of five different communication objects.

In order to display switching states, relative variables such as brightness values, physical variables such as temperature values, the current time or date, it is possible to parameterise individually the object value of each LCD object from 1 bit to 3 bytes.

If more than one text block should be represented, the text can change (scroll) automatically after defined periods, on receipt of a new telegram or after manual operation of a push button.

The input of the display text and several further settings is carried out using the Busch LCD management software. The software is available free of charge on the EIB CD-ROM/diskette. The function of the software is described in the Software/visualisation chapter. When entering the settings, you should ensure that the data (objects) of ETS2 and the display management software match.

Switch

In the default setting of the Busch-triton® switch sensor, there is a 1 bit communication object available for switching for each of the rockers. For special applications, the parameter "Number of switch functions" can be set so that each rocker has two communication objects.

The parameter "Working mode of the rocker" determines which value the switch sensor sends when the left or the right side of the rocker is pressed.

Dim

If the operation mode of the rocker is set to "Dimming sensor", the rocker has the communication objects "Rocker ... -short" for switching and "Rocker ... -long" for dimming.

When carrying out a switching operation, the rocker can either be pressed briefly on the left, on the right or in the middle. The switch sensor always toggles in this case.

For dimming, it is determined via the parameter "Dimming direction" which side of the rocker must be pressed and held down in order to dim up or down. When the rocker is released, the switch sensor sends the telegram "Stop dimming".

Shutter

If the operating mode of the rocker is set to "Shutter sensor", the switch sensor sends "Move shutter up/down" telegrams when the left or right side of the rocker is pressed for a long period. After a short operation anywhere on the rocker, it sends telegrams for stopping the shutter movement or for stepwise louvre adjustment.

The parameter "Shutter direction" determines which side of the rocker must be pressed in order to move upwards or downwards.

LED

If the backlighting of the text fields is switched on, the LEDs can be selected for use either as an orientation light or for status display using the parameter "Operation mode of LED".

In the case of LEDs that are used for status display, it is possible to set which colour (red or green) is assigned to the object values "0" or "1".

The LEDs that are used as an orientation light can either always light up red or always green or they can be switched off.

Application example:

In a training room, there is a group of dimmable downlighters above the seminar participants, two dimmable spotlights above the lecture area and two groups with switchable wall lights. The room can be made darker using two electrically driven shutters.

When the seminar participants enter the room, they should normally only be able to switch the wall lights as the base lighting.

Two 5-fold Busch-triton® switch sensors with dimming actuator/sensors are used together with a dimming actuator, a switch actuator and two shutter actuators.

The two Busch-triton® switch sensors at the doors have almost the same parameter settings:

Function of auxiliary push button:

Interrupt fault protection

Operation mode of rocker 1:

Switching sensor,
1 function, TOGGLE

Operation mode of LED:

shows value of object rocker

Colour of the LED:

OFF = green, ON = red

Operation mode of rocker 2:

Dimming sensor

Operation mode of LED:

shows value of object rocker -short

Colour of the LED:

OFF = green, ON = red

Operation mode of rocker 3:

Dimming sensor

Operation mode of LED:

shows value of object rocker -short

Colour of the LED:

OFF = green, ON = red

Operation mode of rocker 4:

Shutter sensor

Operation mode of LED:

orientation light

Colour of the LED:

always off

Operation mode of rocker 5:

Shutter sensor

Operation mode of LED:

orientation light

Colour of the LED:

always off

The parameters "IR area" have different settings so that both switch sensors do not send telegrams when remote control is used.

The outputs of the dimming actuators/sensors each control one of the spotlights above the lecture area.

The link between the group addresses and the communication objects is almost identical.

The 1 bit communication objects no.1 "Fault protection" are linked with the 1 bit communication objects "Rocker 1" for both switch sensors and with the output of the switch actuator for the wall lights.

The 1 bit and 4 bit communication objects of rocker 2 are linked with the corresponding objects of the dimming actuators for the downlighters.

The communication objects 7 to 9 of the dimming actuator/sensors do not require group addresses in this example. To prepare for possible extensions, it is however advisable to assign separate group addresses to these objects of the two devices.

The communication objects of rockers 4 and 5 for raising and lowering the shutters and for louvre adjustment are linked to the corresponding objects of the shutter actuators.

In principle, the switch sensors operate with an active fault protection function. The wall lights are switched after each operation of any of the rockers.

The lecturer can carry out the same functions via remote control. The IR area can be set as required as both switch sensors react to different settings but carry out the same functions.

Communication objects

for switch sensor with two switch functions, without fault protection and a 3 byte LCD object value (time/date)

No.	Type	Object name	Function
1	1 bit	Backlighting/LED	Switching
3	1 bit	Rocker 1 left	Telegr. switch
4	1 bit	Rocker 1 right	Telegr. switch
5	1 bit	Rocker 2 left	Telegr. switch
6	1 bit	Rocker 2 right	Telegr. switch
7	1 bit	Output	Telegr. switch / switch
8	4 bit	Dimmer	Telegr. dimming / rel. dimming
9	1 byte	Dimmer	Brightness value
10	1 bit	Rocker 4 left	Telegr. switch
11	1 bit	Rocker 4 right	Telegr. switch
12	1 bit	Rocker 5 left	Telegr. switch
13	1 bit	Rocker 5 right	Telegr. switch
14	3 byte	LCD object 14	Time/date
15	3 byte	LCD object 15	Time/date
16	3 byte	LCD object 16	Time/date
17	3 byte	LCD object 17	Time/date
18	3 byte	LCD object 18	Time/date

Communication objects

for switch sensor with two switch functions, with fault protection

No.	Type	Object name	Function
0	1 bit	Input telegr.	Fault protection Off/On
1	1 bit	Backlighting/LED	Switching
2	1 bit	Fault protection	Telegr. switch
...			

Communication objects

for switch sensor with one switch function, without fault protection

No.	Type	Object name	Funktion
1	1 bit	Backlighting/LED	Switching
3	1 bit	Rocker 1	Telegr. switch
5	1 bit	Rocker 2	Telegr. switch
7	1 bit	Output	Telegr. switch / switch
8	4 bit	Dimmer	Telegr. dimming / rel. dimming
9	1 byte	Dimmer	Brightness value
10	1 bit	Rocker 4	Telegr. switch
11	1 bit	Rocker 5	Telegr. switch
...			

Communication objects

for dimming sensor

No.	Type	Object name	Function
...			
3	1 bit	Rocker 1 -short	Telegr. switch
4	1 bit	Rocker 1 -long	Telegr. dimming
5	1 bit	Rocker 2 -short	Telegr. switch
6	1 bit	Rocker 2 -long	Telegr. dimming
7	1 bit	Output	Telegr. switch / switch
8	4 bit	Dimmer	Telegr. dimming / rel. dimming
9	1 byte	Dimmer	Brightness value
10	1 bit	Rocker 4 -short	Telegr. switch
11	1 bit	Rocker 4 -long	Telegr. dimming
12	1 bit	Rocker 5 -short	Telegr. switch
13	1 bit	Rocker 5 -long	Telegr. dimming
...			

Communication objects
for shutter sensor

No.	Type	Object name	Function
...			
3	1 bit	Rocker 1 -long	Teleg. Move up/down
4	1 bit	Rocker 1 -short	Teleg. lamella adj./stop
5	1 bit	Rocker 2 -long	Teleg. Move up/down
6	1 bit	Rocker 2 -short	Teleg. lamella adj./stop
7	1 bit	Output	Teleg. switch / switch
8	4 bit	Dimmer	Teleg. dimming / rel. dimming
9	1 byte	Dimmer	Brightness value
10	1 bit	Rocker 4 -long	Teleg. Move up/down
11	1 bit	Rocker 4 -short	Teleg. lamella adj./stop
12	1 bit	Rocker 5 -long	Teleg. Move up/down
13	1 bit	Rocker 5 -short	Teleg. lamella adj./stop
...			

Communication objects
for 2 byte (value) LCD object value

No.	Type	Object name	Function
...			
14	2 byte	LCD object 14	Value
15	2 byte	LCD object 15	Value
16	2 byte	LCD object 16	Value
17	2 byte	LCD object 17	Value
18	2 byte	LCD object 18	Value

Communication objects
for 1 byte (value) LCD object value

No.	Type	Object name	Function
...			
14	1 byte	LCD object 14	Value
15	1 byte	LCD object 15	Value
16	1 byte	LCD object 16	Value
17	1 byte	LCD object 17	Value
18	1 byte	LCD object 18	Value

Communication objects
for 1 Bit (switching) LCD object value

No.	Type	Object name	Function
...			
14	1 bit	LCD object 14	Switching
15	1 bit	LCD object 15	Switching
16	1 bit	LCD object 16	Switching
17	1 bit	LCD object 17	Switching
18	1 bit	LCD object 18	Switching

Parameters

The default setting for the values is **printed in bold type**.

General:	
– Object for backlighting switches	text field and status LED only text field LED
– Behaviour of backlighting at bus recovery	ON OFF
– Function of auxiliary push button	no function / display operation interrupt fault protection (approx. 5 s) Backlighting and LED on/off
– IR area	blue white no IR
– Push button action interpreted as long from	280 ms / 420 ms / 560 ms / 700 ms / 800 ms
– Switch ON with	minimum brightness maximum brightness
Separate for rockers 1,2 and 4,5:	
– Operation mode of rocker	no function / display operation Shutter sensor Dimming sensor Switching sensor
For switch sensor:	
– Number of switch functions	2 Functions => 2 Objects 1 Function => 1 Object
If 1 function is selected:	
– Working mode of the rocker	TOGGLE left = OFF, right = ON left = ON, right = OFF
– Operation mode of LED	orientation light shows value of object rocker
For display of object value	
– Colour of the LED	OFF = green, ON = red OFF = red, ON = green
For orientation light:	
– Colour of the LED	always green always red always off
If 2 functions are selected:	
– Working mode of the rocker	left = TOGGLE, right = TOGGLE left = TOGGLE, right = OFF left = OFF, right = TOGGLE left = OFF, right = OFF left = TOGGLE, right = ON left = OFF, right = ON left = ON, right = TOGGLE left = ON, right = OFF left = ON, right = ON
– Operation mode of LED	orientation light shows value of object rocker left
For display of object value:	
– Colour of the LED	OFF = green, ON = red OFF = red, ON = green
For orientation light:	
– Colour of the LED	always green always red always off
For dimming sensor:	
– Dimming direction	left = darker, right = brighter left = brighter, right = darker
– Operation mode of LED	orientation light indicates value of obj. rocker -short
For display of object value:	
– Colour of the LED	OFF = green, ON = red OFF = red, ON = green

For orientation light:	
– Colour of the LED	always green always red always off
For shutter sensor:	
– Shutter direction	left = DOWN, right = UP left = UP, right = DOWN
– Operation mode of LED	orientation light shows value of object rocker -long
For display of object value	
– Colour of the ED	OFF = green, ON = red OFF = red, ON = green
For orientation light:	
– Colour of the LED	always green always red always off
If “no function/display operation” is selected:	
– No setting options	
For rocker 3:	
– Operation mode of rocker	Dimming sensor
– Dimming direction	left = darker, right = brighter left = brighter, right = darker
– Operation mode of LED	orientation light shows value of object rocker -short
For display of object value:	
– Colour of the LED	OFF = green, ON = red OFF = red, ON = green
For orientation light:	
– Colour of the LED	always green always red always off
Display:	
Separate for each LCD object:	
– Type of LCD object No. 14	1 Bit 1 Byte 2 Byte 3 Byte (Time/Date)
– Type of LCD object No. 15	1 Bit 1 Byte 2 Byte 3 Byte (Time/Date)
– Type of LCD object no. 16	1 Bit 1 Byte 2 Byte 3 Byte (Time/Date)
– Type of LCD object No. 17	1 Bit 1 Byte 2 Byte 3 Byte (Time/Date)
– Type of LCD object No. 18	1 Bit 1 Byte 2 Byte 3 Byte (Time/Date)

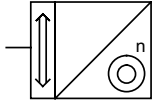
**IR LCD Switch Dim Shutter
Lightscene /3****Selection in ETS2**

- ABB
 - Push Button triton
 - Push button, 5-fold for 1SDA

The application program is intended for the 5-fold Busch-triton® switch sensor application module with display in connection with a switch/dim actuator FM.

The Busch-triton® switch sensor can be used for switching, dimming and shutter control as well as for controlling lightscenes. Various parameters and communication objects are available for the five rockers depending on the setting in the parameters “Number of lightscenes” and “Lightscenes are available on”.

Four lightscenes are available in the default setting which can be recalled via rockers 4 and 5. The other rockers can be used for controlling lightscenes by modifying the parameter “Lightscenes are available on”.

The rockers of the Busch-triton® switch sensor that are not used for lightscene control each have the same set of parameters. With the parameter “Operation mode of rocker”, the basic switching, dimming and shutter control functions can be selected. Depending on this setting, different parameters and objects are available for the rockers. There is a common parameter “Push button action interpreted as long from” for all the rockers that are used for dimming or shutter control. Normally, the switch sensor detects a long push button action if a rocker is pressed for longer than 420 ms.

Backlighting

The backlit text fields display the functions of the rockers even in the dark. Using the communication object “Backlighting/LED”, the backlighting and status LEDs can be switched on or off if required.

The auxiliary push button can also be used for manual switching. To do so, the parameter “Function of auxiliary push button” must be set to “Backlighting and LED on/off”. When the auxiliary push button is pressed, not only is the lighting of the switch sensor switched on or off but a telegram is sent via the communication object “Backlighting/LED”. It is therefore possible to switch on the lighting for several Busch-triton® switch sensors at the same time via a common group address.

By default, the backlighting switches on after bus voltage recovery. This can also be changed via the parameter “Behaviour of backlighting at bus recovery”.

Dimmer output

The output of the dimming actuator/sensor must be linked to objects 9-11. To operate the output locally, the objects “Telegr. switch” and “Telegr. dimming” of one of the rockers that is not used for lightscenes can be linked to the corresponding objects of the output. Object no. 11 “Brightness value” enables the integration of the output in lightscene control.

IR

In addition to using the rockers, the Busch-triton® switch sensor can also be controlled remotely via an infrared hand-held transmitter. The five rockers and the auxiliary push button can be assigned to the white or blue infrared area of the hand-held transmitter. The relevant setting must then be selected via the slide switch on the transmitter. The MEMO button of the transmitter corresponds to the function of the auxiliary push button of the Busch-triton® switch sensor.

LCD

When two lightscenes are used, the display of the Busch-triton® switch sensor can indicate the values of communication object no. 18. With four lightscenes, objects 7, 8 and 18 are available. If 6 lightscenes are used, objects 5...8 and 18 are available.

In order to display switching states, relative variables such as brightness values, physical variables such as temperature values, the current time or date, it is possible to parameterise individually the object value of each LCD object from 1 bit to 3 bytes.

The input of the display text and several further settings is carried out using the Busch LCD management software. The software is available free of charge on the EIB CD-ROM/diskette. The function of the software is described in the Software/visualisation chapter. When entering the settings, you should ensure that the data (objects) of ETS2 and the display management software match.

Switch

In the default setting of the Busch-triton® switch sensor, there is a 1 bit communication object available for switching for each of the rockers that are not assigned lightscenes. For special applications, the parameter "Number of switch functions" can be set so that each rocker has two communication objects.

The parameter "Working mode of the rocker" determines which value the switch sensor sends when the left or the right side of the rocker is pressed.

Dim

If the operation mode of the rocker is set to "Dimming sensor", the rocker has the communication objects "Rocker ...-short" for switching and "Rocker ...-long" for dimming.

When carrying out a switching operation, the rocker can either be pressed briefly on the left, on the right or in the middle. The switch sensor always toggles in this case.

For dimming, it is determined via the parameter "Dimming direction" which side of the rocker must be pressed and held down in order to dim up or down. When the rocker is released, the switch sensor sends the telegram "Stop dimming".

Shutter

If the operating mode of the rocker is set to "Shutter sensor", the switch sensor sends "Move shutter up/down" telegrams when the left or right side of the rocker is pressed for a short period. After a short operation anywhere on the rocker, it sends telegrams for stopping the shutter movement or for stepwise louvre adjustment.

The parameter "Shutter direction" determines which side of the rocker must be pressed in order to move upwards or downwards.

LED

If the backlighting of the text fields is switched on, the LEDs can be selected for use either as an orientation light or for status display using the parameter "Operation mode of LED".

In the case of LEDs that are used for status display, it is possible to set which colour (red or green) is assigned to the object values "0" or "1".

The LEDs that are used as an orientation light can either always light up right or always green or they can be switched off.

Lightscenes

In lightscene mode, up to six scenes with up to six different groups of actuators can be controlled without special lightscene modules.

The lightscenes can be specified via the device parameters. The user can then reconfigure the parameters individually according to his requirements while the installation is in operation. The auxiliary push button is used for storing new lightscenes (parameters). To do this, the parameter "Function of auxiliary push button" must be set to "Storage of lightscenes". To be able to use this function, the transmitting group addresses and flags must be assigned correctly when configuring the actuators.

The lightscenes are configured according to the following process.

1. The number of lightscenes and their respective rocker assignment can be set on the "General" parameter page.
2. For each of the actuator groups A ... F, it must be determined with the parameter "Type of actuator group ...", whether they use 1 bit communication objects (switch or shutter actuators) or 8 bit communication objects (dimming actuators). Depending on this setting, the ETS2 program displays various parameters and communication objects. Communication objects 12 ... 17 are used for the control of actuator groups A ... F.
3. For each of the lightscenes, values can be preset for the actuator groups on their own parameter page.

4. The rockers that are not used for lightscenes are still available for switching, dimming or shutter control. The parameter value "no function / display operation" must be selected for unassigned rockers.

If a rocker is used for recalling lightscenes, the LED indicates which side of the rocker has been pressed. It glows red when the left side is pressed and glows green when the right side is pressed. If several rockers are used, the LED of the rocker which was last pressed lights up.

Application example:

A dimmable lamp is installed in a hotel room in the sleeping area together with a dimmable lamp in the entrance. There is also a reading light by the bed. The room can be darkened with an electrically driven blind. The light in the adjoining bathroom can also be dimmed.

From the door, it should be possible to operate the dimmable lamps in the sleeping area and entrance together but operate the light in the bathroom separately. It should also be possible to operate the blind.

Two lightscenes can be recalled via a push button action:

1. Switch all the lights to almost maximum brightness and raise the blind to clean the room.
2. Switch off all the lights and raise the blind when leaving the room.

From the bed, it should be possible to switch the lights in the sleeping area and entrance together but dim the reading light separately. It should also be possible to operate the blind.

Two lightscenes should be recalled via a push button action:

1. Dim the lights in the bathroom and entrance to semi-brightness to light the way during the night and switch off the reading light.
2. Switch off all the lights for sleeping.

Two 5-fold Busch-triton® switch sensors are used, each with a dimming actuator/sensor FM together with two switch/dim actuators and a shutter actuator.

The Busch-triton® switch sensor at the door has the following parameter settings:

Number of lightscenes:

2

Lightscenes are available on:

Rocker 5

Function of auxiliary push button:
no function / display operation

Operation mode of rocker 1:

Dimming sensor

Operation mode of rocker 2:

Dimming sensor

Operation mode of rocker 3:

Dimming sensor

Operation mode of rocker 4:

Shutter sensor

Operation mode of rocker 5:

Rocker is assigned to two lightscenes

Rocker is assigned to IR push button:
no IR

Type of actuator group A:

Dimming actuator (8 bit)

Type of actuator group B:

Dimming actuator (8 bit)

Type of actuator group C:

Dimming actuator (8 bit)

Type of actuator group D:

Dimming actuator (8 bit)

Type of actuator group E:

Switch or shutter actuator (1 bit)

The two lightscenes are defined as follows:

Lightscene 1: Base lighting

Actuator group A: 80%,
Actuator group B: 80%,
Actuator group C: 80%,
Actuator group D: 80%,
Actuator group E: UP

Lightscene 2: OFF

Actuator group A: 0%,
Actuator group B: 0%,
Actuator group C: 0%,
Actuator group D: 0%,
Actuator group E: UP

The 1 bit and 4 bit communication objects of rockers 1 and 2 are linked to the corresponding objects of the actuators for the luminaires in the entrance area and sleeping area.

The two objects of rocker 3 are linked to the objects of the dimming actuator/sensor.

The transmit flags are set for the switching objects of the dimming actuators. The status LEDs can also be controlled when the lightscenes are recalled.

The two objects of rocker 4 are linked with the corresponding objects of the shutter actuator.

The 1 byte communication objects of actuator groups A and B are linked with the 1 byte objects of the dimming actuators.

The 1 byte object of actuator group C is linked with the 1 byte object of the dimming actuator/sensor at the door.

The 1 byte communication object of actuator group D is linked with the 1 byte object of the dimming actuator/sensor at the bed.

The 1 bit communication object of actuator group E is linked with the object of the shutter actuator that raises and lowers the blind.

The Busch-triton® switch sensor by the bed has the following parameter settings:

Number of lightscenes:

2

Lightscenes are available on:

Rocker 5

Function of auxiliary push button:
no function / display operation

Operation mode of rocker 1:

Dimming sensor

Operation mode of rocker 2:

Dimming sensor

Operation mode of rocker 3:

Dimming sensor

Operation mode of rocker 4:

Shutter sensor

Operation mode of rocker 5:

Rocker is assigned to two lightscenes

Rocker is assigned to IR push button:

no IR

Type of actuator group A:

Dimming actuator (8 bit)

Type of actuator group B:

Dimming actuator (8 bit)

Type of actuator group C:

Dimming actuator (8 bit)

Type of actuator group D:

Dimming actuator (8 bit)

Type of actuator group E:

Switch or shutter actuator (1 bit)

The two lightscenes are defined as follows:

Lightscene 1: Passageway lighting

Actuator group A: 40%,

Actuator group B: 40%,

Actuator group C: 40%,

Actuator group D: 0%

Lightscene 2: OFF

Actuator group A: 0%,

Actuator group B: 0%,

Actuator group C: 0%,

Actuator group D: 0%

The 1 bit and 4 bit communication objects of rockers 1 and 2 are linked with the corresponding objects of the actuators for the lights in the entrance area and sleeping area.

The two objects of rocker 3 are linked with the objects of the dimming actuator/sensor.

The transmit flags are set for the switching objects of the dimming actuators. The status LEDs can also be controlled when the lightscenes are recalled.

The two objects of rocker 4 are linked with the corresponding objects of the shutter actuator.

The 1 byte communication objects of actuator groups A and B are linked with the 1 byte objects of the dimming actuators.

The 1 byte object of actuator group C is linked with the 1 byte object of the dimming actuator/sensor at the door.

The 1 byte communication object of actuator group D is linked with the 1 byte object of the dimming actuator/sensor by the bed. The 1 bit communication object of actuator group E is not required for this switch sensor. The hotel guest can thus freely decide whether he sleeps with the blind open or closed.

In this case, the auxiliary push buttons are not used for saving lightscenes so that a hotel guest does not inadvertently modify the set lightscenes. The read flag should not however be set for the communication objects that are used for shutter control in both the sensors and the actuator. If it is required that the lightscenes are parameterised locally, this prevents the blind from being accidentally set in motion.

ABB i-bus® EIB

Switch/dim actuator, FM
Type: 6114 U-500 + 6325-xx

Communication objects

for switch sensor with two switch functions, 3 byte LCD object value and 4 lightscenes on rockers 4 and 5

No.	Type	Object name	Function
0	1 bit	Backlighting/LED	Switching
1	1 bit	Rocker 1 left	Teleg. switch
2	1 bit	Rocker 1 right	Teleg. switch
3	1 bit	Rocker 2 left	Teleg. switch
4	1 bit	Rocker 2 right	Teleg. switch
5	1 bit	Rocker 3 left	Teleg. switch
6	1 bit	Rocker 3 right	Teleg. switch
7	3 byte	LCD object 7	Time/date
8	3 byte	LCD object 8	Time/date
9	1 bit	Output	Teleg. switch / switch
10	4 bit	Dimmer	Teleg. dimming / rel. dimming
11	1 byte	Dimmer	Brightness value
12	1 bit	Actuator group A	Teleg. switch
13	1 bit	Actuator group B	Teleg. switch
14	1 bit	Actuator group C	Teleg. switch
15	1 bit	Actuator group D	Teleg. switch
16	1 bit	Actuator group E	Teleg. switch
17	1 bit	Actuator group F	Teleg. switch
18	3 byte	LCD object 18	Time/date

Communication objects

for switch sensor with two switch functions and 2 lightscenes on rocker 5

No.	Type	Object name	Function
0	1 bit	Backlighting/LED	Switching
1	1 bit	Rocker 1 left	Teleg. switch
2	1 bit	Rocker 1 right	Teleg. switch
3	1 bit	Rocker 2 left	Teleg. switch
4	1 bit	Rocker 2 right	Teleg. switch
5	1 bit	Rocker 3 left	Teleg. switch
6	1 bit	Rocker 3 right	Teleg. switch
7	1 bit	Rocker 4 left	Teleg. switch
8	1 bit	Rocker 4 right	Teleg. switch
9	1 bit	Output	Teleg. switch / switch
10	4 bit	Dimmer	Teleg. dimming / rel. dimming
11	1 byte	Dimmer	Brightness value
...			

Communication objects

for switch sensor with two switch functions and 6 lightscenes on rockers 1 to 3

No.	Type	Object name	Function
0	1 bit	Backlighting/LED	Switching
1	1 bit	Rocker 3 left	Teleg. switch
2	1 bit	Rocker 3 right	Teleg. switch
3	1 bit	Rocker 4 left	Teleg. switch
4	1 bit	Rocker 4 right	Teleg. switch
5	3 byte	LCD object 5	Time/date
6	3 byte	LCD object 6	Time/date
7	3 byte	LCD object 7	Time/date
8	3 byte	LCD object 8	Time/date
9	1 bit	Output	Teleg. switch / switch
10	4 bit	Dimmer	Teleg. dimming / rel. dimming
11	1 byte	Dimmer	Brightness value
...			

Communication objects
for 4 lightscenes on rockers 4 and 5
with dimming sensor

No.	Type	Object name	Function
...			
12	1 byte	Actuator group A	Teleg. brightness value
13	1 byte	Actuator group B	Teleg. brightness value
14	1 byte	Actuator group C	Teleg. brightness value
15	1 byte	Actuator group D	Teleg. brightness value
16	1 byte	Actuator group E	Teleg. brightness value
17	1 byte	Actuator group F	Teleg. brightness value

Communication objects
for switch sensor with one switch
function and 4 lightscenes on
rockers 4 and 5

No.	Type	Object name	Function
0	1 bit	Backlighting/LED	Switching
1	1 bit	Rocker 1	Teleg. switch
3	1 bit	Rocker 2	Teleg. switch
5	1 bit	Rocker 3	Teleg. switch
...			

Communication objects
for dimming sensor and 4 lightscenes
on rockers 4 and 5

No.	Type	Object name	Function
0	1 bit	Backlighting/LED	Switching
1	1 bit	Rocker 1 left	Teleg. switch
2	1 bit	Rocker 1 right	Teleg. dimming
3	1 bit	Rocker 2 left	Teleg. switch
4	1 bit	Rocker 2 right	Teleg. dimming
3	1 bit	Rocker 3 left	Teleg. switch
4	1 bit	Rocker 3 right	Teleg. dimming
...			

Communication objects
for shutter sensor and 4 lightscenes on
rockers 4 and 5

No.	Type	Object name	Function
0	1 bit	Backlighting/LED	Switching
1	1 bit	Rocker 1 -long	Teleg. Move up/down
2	1 bit	Rocker 1 -short	Teleg. lamella adj./stop
3	1 bit	Rocker 2 -long	Teleg. Move up/down
4	1 bit	Rocker 2 -short	Teleg. lamella adj./stop
5	1 bit	Rocker 3 -long	Teleg. Move up/down
6	1 bit	Rocker 3 -short	Teleg. lamella adj./stop
7	1 bit	Rocker 4 -long	Teleg. Move up/down
8	1 bit	Rocker 4 -short	Teleg. lamella adj./stop
...			

Parameters

The default setting for the values is **printed in bold type**.

General:	
– Object for backlighting switches	text field and status LED only text field LED
– Behaviour of backlighting at bus recovery	ON OFF
– Function of auxiliary push button	no function / display operation Storage of lightscenes
– Number of lightscenes	2 / 4 / 6
For 2 lightscenes:	
– Lightscenes are available on	Rocker 1 Rocker 2 Rocker 3 Rocker 4 Rocker 5
For 4 lightscenes:	
– Lightscenes are available on	Rockers 1 and 2 Rockers 2 and 3 Rockers 3 and 4 Rockers 4 and 5
For 6 lightscenes:	
– Lightscenes are available on	Rockers 1 to 3 Rockers 2 to 4 Rockers 3 to 5
– Wait state between telegrams by activating lightscenes (base 140 ms)	0
– IR area	blue white no IR
– Push button action interpreted as long from	280 ms / 420 ms / 560 ms / 700 ms / 840 ms
– Switch ON with	minimum brightness maximum brightness
Separate for each rocker:	
With lightscene operation:	
– Rocker is assigned to two lightscenes	← NOTE
Without lightscene operation:	
– Operation mode of rocker	no function / display operation Shutter sensor Dimming sensor Switching sensor
For switch sensor function:	
– Number of switch functions	2 Functions => 2 Objects 1 Function => 1 Object
For one function:	
– Working mode of the rocker	TOGGLE left = OFF, right = ON left = ON, right = OFF
– Operation mode of LED	orientation light shows value of object rocker
For display of the object value:	
– Colour of the LED	OFF = green, ON = red OFF = red, ON = green
For orientation light:	
– Colour of the LED	always green always red always off

For 2 functions:	
- Working mode of the rocker	left = TOGGLE, right = TOGGLE left = TOGGLE, right = OFF left = OFF, right = TOGGLE left = OFF, right = OFF left = TOGGLE, right = ON left = OFF, right = ON left = ON, right = TOGGLE left = ON, right = OFF left = ON, right = ON
- Operation mode of LED	orientation light shows value of object rocker left
For display of object value:	
- Colour of the LED	OFF = green, ON = red OFF = red, ON = green
For orientation light:	
- Colour of the LED	always green always red always off
For dimming sensor:	
- Dimming direction	left = darker, right = brighter left = brighter, right = darker
- Operation mode of LED	orientation light shows value of object rocker -short
For display of object value:	
- Colour of the LED	OFF = green, ON = red OFF = red, ON = green
For orientation light:	
- Colour of the LED	always green always red always off
For shutter sensor:	
- Shutter direction	left = DOWN, right = UP left = UP, right = DOWN
- Operation mode of LED	orientation light shows value of object rocker -long
For display of object value:	
- Colour of LED	OFF = green, ON = red OFF = red, ON = green
For orientation light:	
- Colour of the LED	always green always red always off
If "no function / display operation" is selected:	
- No setting options	
Actuator types for lightscenes:	
Separate for each actuator group:	
- Type of actuator group A ... F	Switch or shutter actuator (1 bit) Dimming actuator (8 bit)
Separate for each lightscene:	
For switch or shutter actuator:	
- Preset actuator group A ... F	OFF / UP ON / DOWN
For dimming actuator:	
- Preset actuator group A ... F	0 % / 5 % / ... / 95 % / 100 %
Display:	
Separate for each LCD object:	
- Type of LCD object No. ...	1 Bit: Switching 1 Byte (Value) 2 Byte (Value) 3 Byte (Time/Date)